



Studio Display

Repair Manual

Contents

3 [Introduction](#)

Basics

6 [Exploded View and Orderable Parts](#)

9 [Screws](#)

11 [Tools](#)

Safety

15 [Broken Glass Safety](#)

16 [Electrical Safety](#)

Procedures

17 [First Steps](#)

18 [Display \(Stand\)](#)

34 [Display \(VESA Mount Adapter\)](#)

48 [Logic Board](#)

55 [Left Fan](#)

63 [Right Fan](#)

71 [USB-C Boards](#)

77 [Power Supply Boards](#)

89 [Cables](#)

100 [Power Cord Port](#)

108 [Power Cord](#)

112 [Tilt-Adjustable Stand](#)

121 [Tilt- and Height-Adjustable Stand](#)

128 [VESA Mount Adapter](#)

133 [Housing](#)

Introduction

This manual includes technical instructions for replacing genuine Apple parts in an Apple display and is intended for individual technicians with the knowledge, experience, and tools required to repair electronic devices.

Important

- Read the entire manual first. If you're not comfortable performing the repairs as instructed in this manual, don't proceed.
- Always use the latest version of this document available at support.apple.com/en_US/manuals/displaysandaccessories.



Warning

Failure to follow the repair instructions or to use genuine Apple parts or proper tools may cause electric shock or other safety issues and lead to personal injury or death.



Caution

Failure to follow the repair instructions or to use genuine Apple parts or proper tools may damage the Apple display, parts, or other property, or compromise the device's functionality.

Warranty information

Damage caused by repairs performed outside of Apple or the Apple Authorized Service Provider network is not covered by Apple's warranty or AppleCare plans. Such damage may cause future repairs to be subject to out-of-warranty costs or render the device ineligible for future repairs by Apple or Apple Authorized Service Providers.

Tools and parts

Ordering tools and parts

You can learn how to order genuine Apple parts and tools at support.apple.com/self-service-repair. During the purchase process, enter the manual ID **YDVPMR** to indicate that you've read this manual in its entirety and agree that you have the knowledge and experience to perform your intended repair.

Software tools

A System Configuration step may be required at the end of your repair. System Configuration is a postrepair software tool that completes the repair for genuine Apple parts. Running System Configuration has a number of purposes that vary based on the part replaced.

What System Configuration does	Why it's important
Transfers factory calibration values	Certain parts like displays, cameras, and ambient light sensors have calibration values that are customized to each individual part during manufacturing. These calibration values are required for proper functionality of True Tone and Center Stage. Transferring these values ensures maximum performance and quality after a repair.
Ensures repair integrity	After a hardware repair, software checks are performed to ensure repair integrity. Repair integrity means that a genuine Apple part has been correctly installed.
Updates replacement logic board with device serial number	Transferring the device serial number to the logic board will allow you to see the serial number in System Profiler.
Assigns wireless region	To comply with regional communications regulations, a wireless region must be assigned to your logic board.
Updates firmware	Keeping firmware up to date ensures that the device has all the latest security and performance features.

After performing a display or logic board repair in Studio Display, a Mac with [Apple Service Utility](#) installed is required to perform System Configuration.

Before initiating the System Configuration process, ensure that you have the following:

- The latest version of Apple Service Utility installed on a Mac running macOS Monterey 12.4 or later
- Internet access
- A USB-C charge cable or a USB-A to USB-C cable

Note: The USB-C cable must support both power and data. Don't use Thunderbolt 3 cables.

System Configuration requires a strong Wi-Fi network capable of 1.0 Mbps download and upload speeds, with less than 400 ms latency and less than 2% packet loss. Estimated data usage to run System Configuration is 6–22 MB.

Learn how to initiate the System Configuration process at support.apple.com/self-service-repair.

Alerts

Failure to follow alerts could result in electric shock, injury, data loss, or damage to the device, parts, or other property.



Danger

Instructions for reducing risk of electric shock and electrocution



Warning

Instructions for reducing risk of personal injury



Caution

Instructions for reducing risk of data loss or device hardware damage

Important

Supplemental information for successfully completing procedures; neither a Warning nor a Caution

Exploded View and Orderable Parts

This section shows parts, part names, and part numbers for Studio Display.

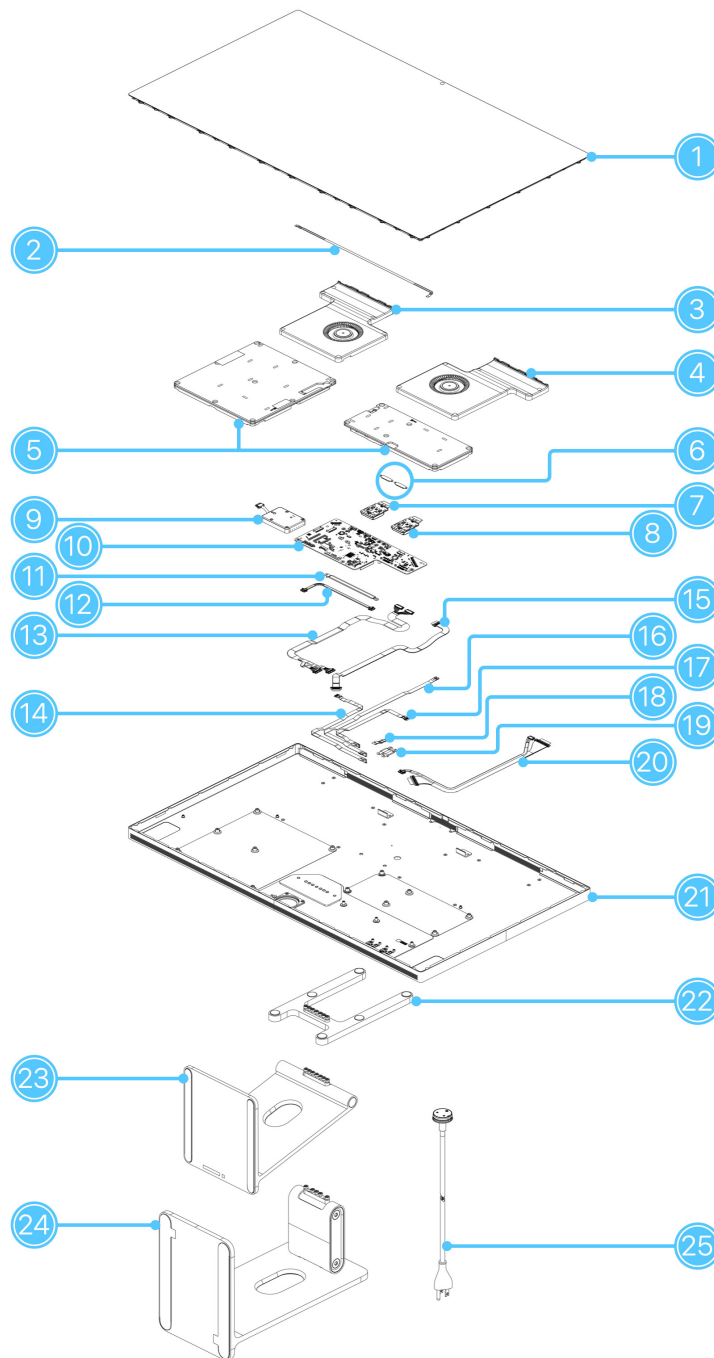

Part Name	Number
1. Display	661-25195, standard 661-25196, nano-texture
2. Ambient light sensor flex cable	923-07129
3. Left fan	923-07127
4. Right fan	923-07191
5. Power supply boards	661-25194
6. USB-C board connector cowlings	923-07147
7. Left USB-C board	923-07139
8. Right USB-C board	923-07533
9. Power cord port	923-07126
10. Logic board	661-25193
11. Power supply bus bar	923-07148
12. Power supply signal cable	923-07135
13. Display backlight cable	923-07131
14. Left fan flex cable	923-07134
15. Camera flex cable	923-07136
16. Microphone flex cable	923-07132
17. Right fan flex cable	923-07133
18. Power supply signal flex cable	923-07128
19. Logic board bus bar	923-07149
20. DisplayPort power/signal cable bundle	923-07576
21. Housing	923-07156
22. VESA mount adapter	923-07313
23. Tilt-adjustable stand	923-07312
24. Tilt- and height-adjustable stand	923-07311
25. Power cord	923-05156
Read the Important alert on the next page to ensure that you order the correct power cord.	
Part Name (Not Shown)	Number
Cable cover	923-07130

Important

The English (US) power cord part number begins with 923. Other regional power cord part numbers also begin with 923, but include a regional prefix. For example, the power cord part number for Italy begins with CI923. Identify the correct regional prefix from the list below:

- B United Kingdom
- CI Italy
- D Belgium/Luxembourg, France, Germany, Poland, Spain, Sweden

Screws

Caution

- Save undamaged screws and cowlings for reassembly.
- Note the location of screws and cowlings during removal. Then organize them to ensure that you reinstall them in the correct location.
- Both overtightened screws and loose screws can damage parts.

452-06708
Torx® Plus 20IP¹

Tilt-adjustable stand (6)



452-06710
Torx Plus 20IP¹

Tilt-adjustable stand (1)



452-06742
Torx Plus 20IP²

VESA mount adapter (7)



452-07329
Torx Plus 20IP³

Tilt- and height-adjustable stand (4)



452-07330
Torx Plus 20IP³

Tilt- and height-adjustable stand (1)



923-05561
Torx T3

USB-C cowlings (4)



923-07140
Torx T5

Left fan (6)
Right fan (6)



923-07141
Torx T6

Logic board bus bar (4)
Power supply boards bus bar (2)



923-07142

Torx T6

Logic board (5)

**923-07143**

Torx T8

Power supply boards (12)

**923-07144**

Torx T3

USB-C boards (6)

**923-07145**

Torx T5

Power cord port (1)

**923-07146**

Torx T5

Power cord port (4)



¹ Included only with tilt-adjustable stand (923-07312) and housing (923-07156)

² Included only with VESA mount adapter (923-07313) and housing (923-07156)

³ Included only with tilt- and height-adjustable stand (923-07311) and housing (923-07156)

Tools

Tools with part numbers are available for purchase from the Self Service Repair Store. Tools without part numbers can be purchased from electronics supply retailers.

818-3269
Adhesive cutter



818-16990
Adhesive cutter replacement wheel



923-02995
Adjustable torque driver
(10–34 Ncm)



923-0735
Adjustable torque driver
(0.3–1.2 Nm)



923-07181
Adjustable torque wrench
(2.5–25 Nm)



923-07525
Alignment pins (2 mm)



923-07526
Alignment pin (3 mm)



923-07527
Alignment pin (4 mm)



923-07528
Alignment pins for stand
and VESA mount adapter



923-01368
Cut-resistant gloves



076-00517
Display refill kit¹

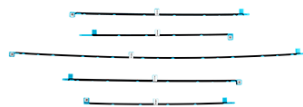

076-00516
Display starter kit²

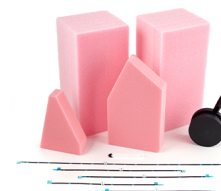

923-0416
Display support stand⁴

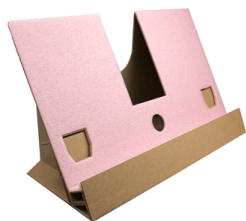

ESD mat

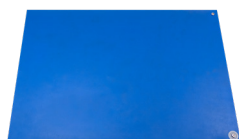

ESD wrist strap with clip or plug



ESD-safe tweezers



Ethanol wipes³



Flathead screwdriver



Isopropyl alcohol (IPA) wipes



922-1731
Kapton tape

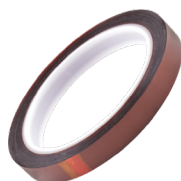

Magnetizer

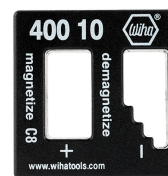

922-9275
Microfoam bag



Microterry polishing cloth



922-5065
Nylon probe (black stick)



Packing tape



923-07532
Power cord removal tool



Safety glasses with side shields



922-8261
Silicone roller



922-8262
Sticky sheet pad



923-07529
Support foam rest blocks

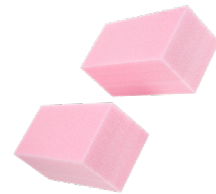

923-07531
Support wedge, tilt-adjustable stand



923-07530
Support wedge, tilt- and height-adjustable stand



923-07303
Torx Plus 20IP 70 mm bit



Torx T3 screwdriver



923-02996
Torx T5 bit



Torx T5 screwdriver



Torx T6 screwdriver



923-00304

Torx T6 security bit⁵

923-0734

Torx T8 bit



Torx T8 screwdriver



USB-C charge cable



¹ The display refill kit (076-00517) includes an adhesive cutter, adhesive cutter replacement wheels, and display adhesive strips.

² The display starter kit (076-00516) includes the following tools:

- Adhesive cutter
- Adhesive cutter replacement wheels
- Alignment pins (2 mm)
- Alignment pin (3 mm)
- Alignment pin (4 mm)
- Alignment pins for stand and VESA mount adapter
- Display adhesive strips
- Power cord removal tool
- Support foam rest blocks
- Support wedge for tilt-adjustable stand
- Support wedge for tilt- and height-adjustable stand

³ Ethanol wipes must contain at least 90% ethanol and no additives except isopropyl alcohol.

⁴ The display support stand is an optional tool. You can perform the display procedure without using the display support stand.

⁵ You can use a Torx T6 bit or Torx T6 security bit.

Broken Glass Safety

Warning

The display glass will break into pieces if mishandled. If the display breaks and glass gets in your eye, perform the following steps:

- Immediately seek medical attention.
- Don't rub your eye.
- Don't wash your eye. Washing your eye can move the shard of glass and cause more damage.
- Keep your eye closed or loosely patch it to keep it still.

Tools

- Cut-resistant gloves
- Packing tape
- Safety glasses with side shields

Perform the following steps to secure a display with broken glass:

1. Put on safety glasses with side shields and the cut-resistant gloves.
2. If the display is broken and is still attached to the housing, secure the broken glass with packing tape and remove the display.
3. Lay the display on a smooth, clean work surface.
4. Thoroughly cover the broken display with packing tape.



Electrical Safety



The power supply remains powered when the device is plugged in whether or not the device has been turned on. Don't touch the logic board or power supply while the device is plugged into an electrical outlet.

Be aware of the following precautions to avoid electric shock:

- Never remove or install any parts while the device is plugged into an electrical outlet.
- Always wait at least 2 minutes after unplugging the device to allow the logic board or power supply or both to discharge.
- Don't touch the logic board or power supply before the 2-minute discharge wait time has passed.

First Steps

Always perform the following steps before starting a repair:

- Unplug the power cord from the electrical outlet. Keep the power cord unplugged while the device is being repaired.
- Disconnect all other cables from the device.
- Clear and clean your workspace.
- Put on an ESD wrist strap and attach it to a properly grounded ESD mat.



Caution

ESD (electrostatic discharge, or the release of static electricity) can damage electronic components.

Be aware of the following while performing a repair:

- The manual for this model may show images of other models, but the procedures are the same. Ensure that you use the correct tools for the model you're repairing.
- Take your time. Thoroughly read all instructions and alerts.
- Magnetizing the screwdrivers will make it easier to work with small screws.
- Use only Kapton tape to secure cables and keep them out of the way when removing and reinstalling parts.
- The end of each flex cable must align with its connector. Press the end of each flex cable to its connector until it clicks to ensure that it's secure.

Display (Stand)

Before You Begin

Danger

Ensure that the power cord is not plugged into an electrical outlet.

Warning

Read [Broken Glass Safety](#) before you begin.

Caution

Some images show the power cord removed from the display, but during this procedure, the power cord should remain connected to the display.

Tools

- Adhesive cutter
- Adhesive cutter replacement wheels
- Display adhesive strips
- Display support stand
- ESD-safe tweezers
- Ethanol wipes or IPA wipes
- Microfoam bag
- Nylon probe (black stick)
- Safety glasses
- Silicone roller
- Sticky sheet pad
- Support foam rest blocks
- Support wedge: tilt-adjustable stand
- Support wedge: tilt- and height-adjustable stand



⚠ Caution

This procedure requires System Configuration. To perform System Configuration you will need the following:

- The latest version of [Apple Service Utility](#) installed on a Mac running macOS 12.4 or later
- Internet access
- A USB-C charge cable or a USB-A to USB-C cable. The USB-C cable must support both power and data. Don't use Thunderbolt 3 cables.

After you've completed all removal and reassembly steps and configured the Mac with Apple Service Utility, learn how to initiate the System Configuration process at support.apple.com/self-service-repair.

⚠ Caution

The adhesive cutter has replacement wheels. You will likely need to use several wheels because when a wheel is chipped, dented, broken, or no longer flat, you must replace it. Using a damaged wheel can damage the polyester tape on the display.

Damaged wheel**New wheel****Important**

- To remove the display, you must cut adhesive strips that attach the display to the rear housing. Each strip has a foam layer surrounded by two adhesive layers. You'll use the adhesive cutter to cut the adhesive strips and will be cutting mostly through the foam layer.
- For models configured with the VESA mount adapter, refer to the [Display \(VESA mount adapter\)](#) removal and reassembly instructions.

Removal

1. Tilt the display all the way up and insert the support wedge.



2. Cut the display adhesive strips by inserting the adhesive cutter between the display and the housing. Start from a corner and move the wheel around the edges of the display.



Important

- If your display uses the tilt-adjustable stand, follow step 3.
- If your display uses the tilt- and height-adjustable stand, skip to step 4.

3. Place the tilt- and height-adjustable stand support wedge parallel to the display as shown. Then skip to step 5.

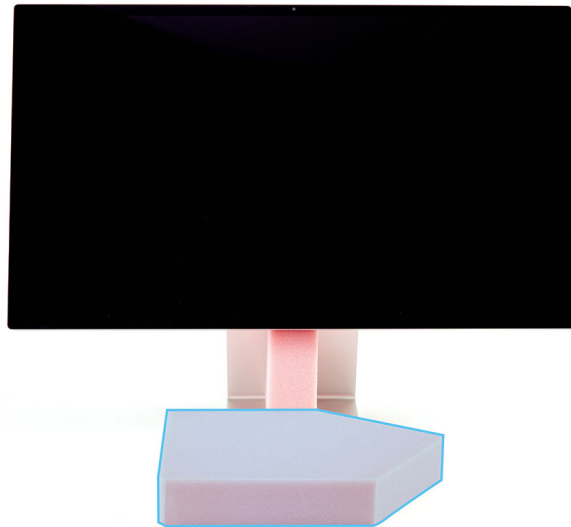

4. Place the support foam rest blocks perpendicular to the display with the lines in the blocks running vertical as shown.



5. While supporting the display, move your fingers along the edges and gently lift to ensure that the adhesive has been completely cut away. If not, use the adhesive cutter to cut the remaining adhesive.



6. Carefully separate the display from the housing, ensuring that you clear the hangers near the top of the housing. Support the bottom of the display with one hand while you tilt the top of the display away from the housing.



7. Rest the display on the stand support wedge or foam rest blocks.



8. Pull the tab to flip up the locking bar on the DisplayPort signal flex cable (1). Then slide the end of the flex cable out of the connector (2).

Important

The DisplayPort signal flex cable has a small area of adhesive that adheres to the back of the display. If the flex cable is still adhered to the back of the display, use the black stick to release it.



9. Slide the end of the DisplayPort power cable out of the connector (3).

10. Pull the tab to flip up the locking bar (1) on the camera flex cable. Then slide the end of the flex cable out of the connector (2).
11. Gently wiggle the ends of the display backlight cables out of the connectors (3).

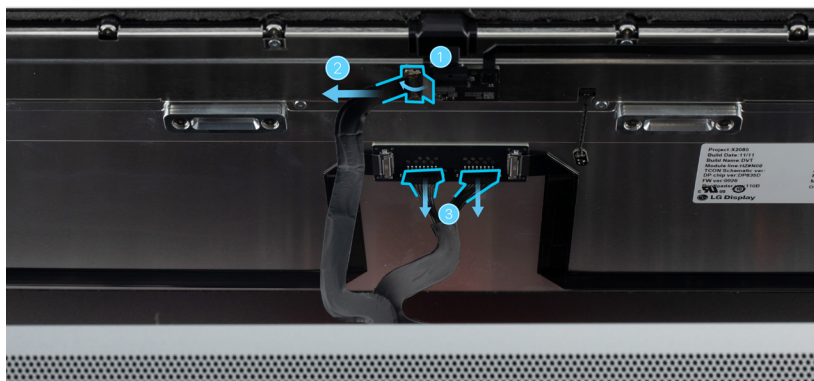

12. Set the display on the display support stand.

Important

If you don't have a display support stand, lay the display facedown on a clean, soft towel. To avoid damage to the display, ensure that the flex cables don't touch the towel.

13. Use ESD-safe tweezers to peel the display adhesive from the back of the display edges as shown.

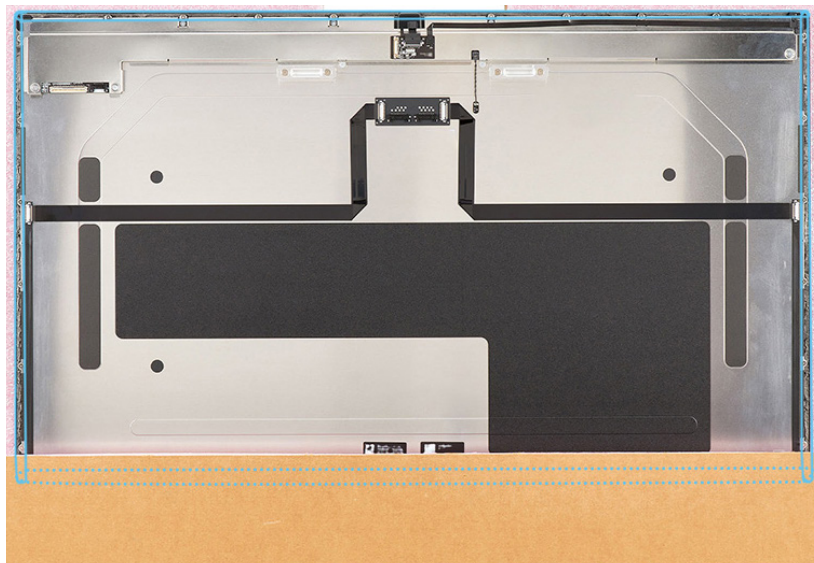

⚠ Caution

- To prevent damage to the polyester film on the display, don't peel adhesive residue from the corners of the display.
- Don't use ethanol wipes or IPA wipes on the display. Ethanol or isopropyl alcohol may damage the polyester film.

14. Use ESD-safe tweezers to peel the display adhesive from the edges of the housing as shown.
15. Use ethanol wipes or IPA wipes to clean any remaining adhesive residue from the housing.

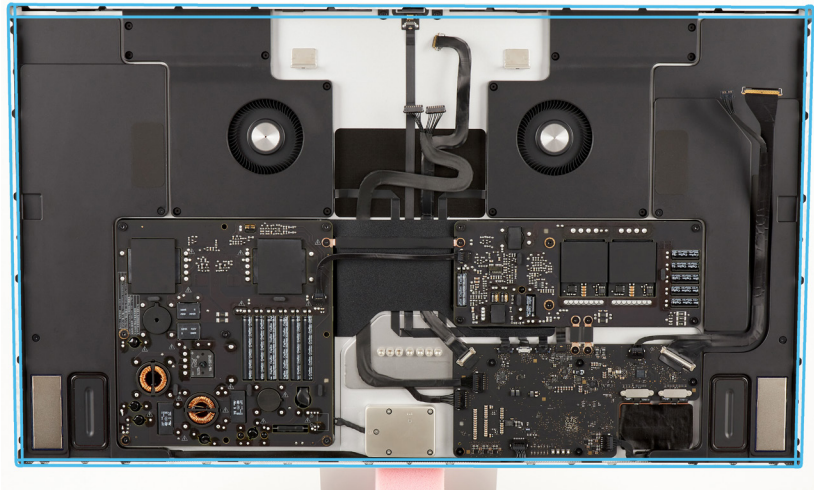

Reassembly

1. Place the display adhesive strips on a flat surface and check them for damage and wrinkles. Refer to the part numbers on the adhesive strips to identify the correct position of the adhesive strips:

- Bottom (946-21413) (1)
- Upper left (946-21414) (2)
- Upper right (946-21415) (3)
- Right (946-21416) (4)
- Left (946-21417) (5)

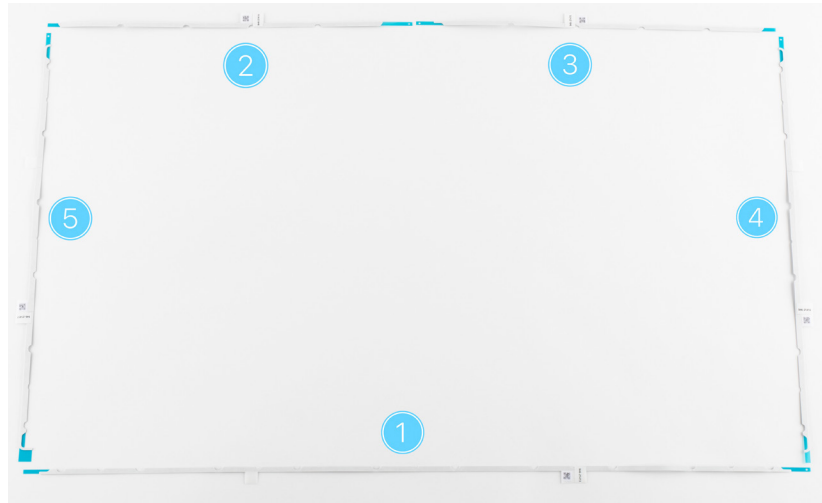

Caution

Damaged display adhesive strips can cause cosmetic gaps and light leakage. They can also weaken the bond between the display and the housing. If the adhesive strips are wrinkled or damaged, replace them.

Note: The display adhesive strips have two layers of adhesive with a foam layer between them. There is a paper release liner on the underside and a plastic release liner on the top. The colors of the release liners may vary.

2. Peel off sections of the paper release liner from the left display adhesive strip as you press the adhesive strip to the edge of the housing. Then use the flat end of the black stick to firmly press along the length of the adhesive strip to adhere it to the housing.

Important

Ensure that you match the display adhesive strip pattern to the housing pattern.



3. Repeat step 2 to install the display adhesive strips on the right, upper left, upper right, and the bottom edges of the housing.

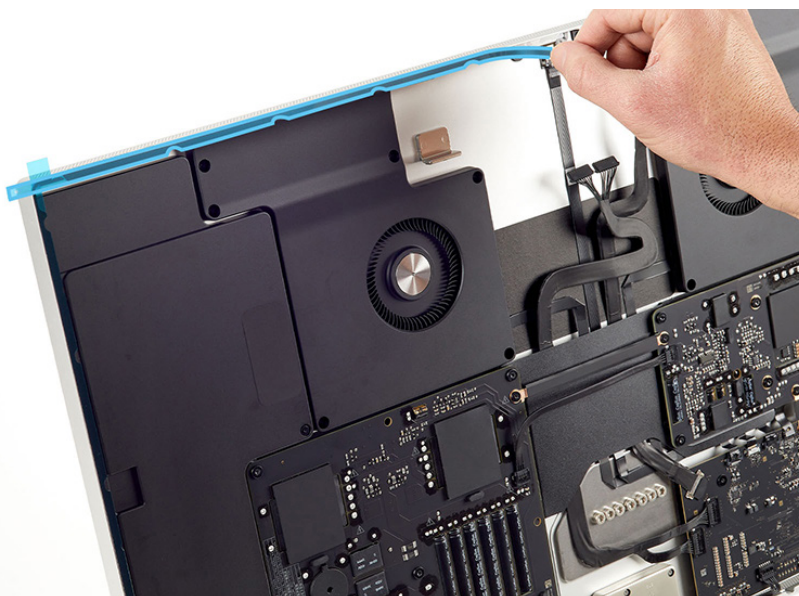

Important

- If your display uses the tilt-adjustable stand, follow step 4.
- If your display uses the tilt- and height-adjustable stand, skip to step 5.

4. Position the tilt- and height-adjustable stand support wedge in front of the housing as shown. Place the display on the stand support wedge in front of the housing. Then skip to step 6.



5. Position the support foam rest blocks under the housing as shown. Then place the display on the foam rest blocks in front of the housing.



6. Slide the ends of the display backlight cables (1) into the connectors.
7. Slide the end of the camera flex cable into the connector (2). Then flip down the locking bar on the flex cable (3).

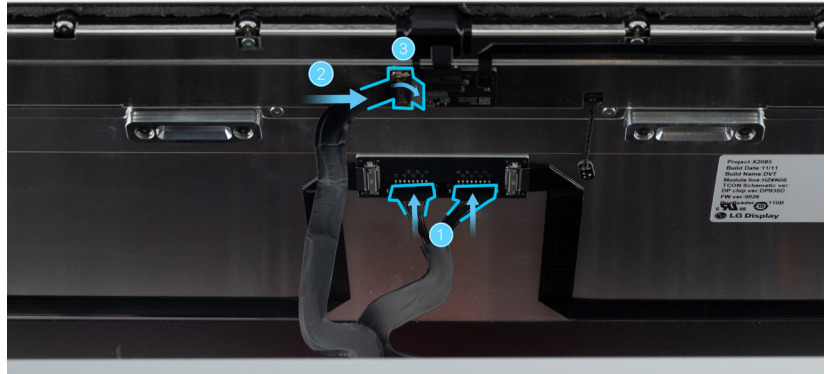

8. Slide the end of the DisplayPort power cable into the connector (1).
9. Slide the end of the DisplayPort signal flex cable into the connector (2). Then flip down the locking bar on the flex cable (3).

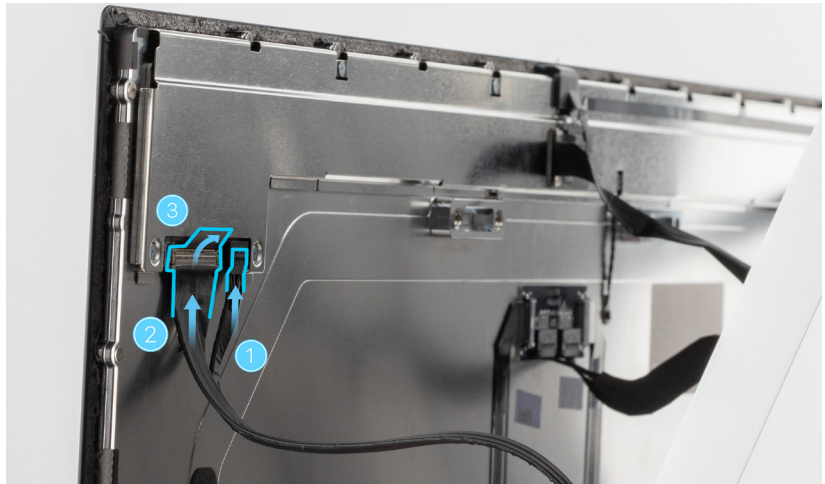

10. Lift the display and hang it on the two hangers near the top of the housing.

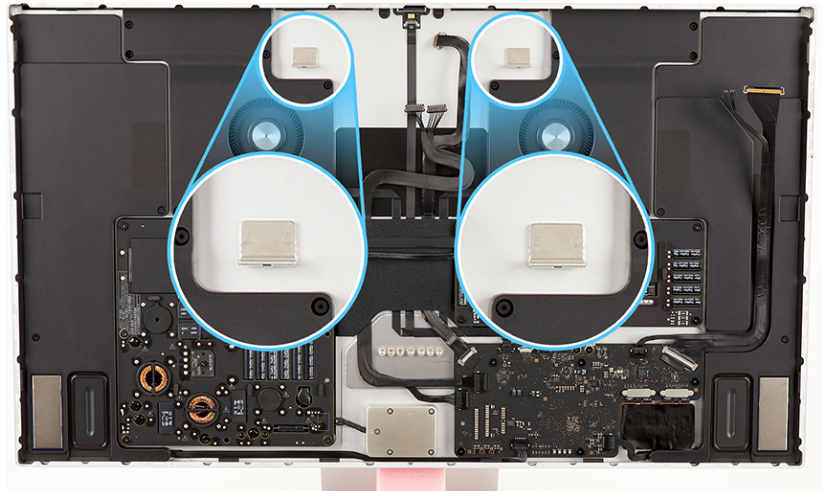

11. Place the two large foam blocks on the table with the lines in the blocks running vertical as shown. Place the entire unit on top of the foam blocks with the display faceup. Remove the support wedge. Then align the display with the housing.



12. Separate the display just enough to remove the release liner from the bottom edge of the display. Repeat the motion along the perimeter of the display until the release liners are removed from the left, right, and top edges.



13. Remove the liner from the sticky sheet pad. Roll the silicone roller back and forth on the sticky sheet pad to clean it.



14. Roll the silicone roller across each edge of the display six times.



15. Use both hands to press the edge of the display and help set the adhesive. Move your hands along the edge of the display, pressing at each location.



16. Place the display in the microfoam bag. Then place it flat on a clean table with the display side facedown. Wait 30 minutes for the adhesive to attach to both the display and the housing.



Caution

Don't drag the display on the table.

17. Remove the display from the microfoam bag and stand it upright.

Important

- If you reinstalled the existing display or logic board, the repair is complete.
- If you replaced the display or logic board, complete steps 18 through 20. Ensure that you have a Mac with [Apple Service Utility](#) installed and a USB-C charge cable before you continue.

- Open the Apple Service Utility app on the Mac. Ensure that all Resources have been installed.

Note: The time to download and install Resources will vary based on your network connection speed to the internet.



- Plug the display power cord into an electrical outlet.
- Plug one end of the USB-C charge cable into the Mac. Then plug the other end of the USB-C charge cable into the Thunderbolt 3 port on the back of the display. The Thunderbolt 3 port is the rightmost port.

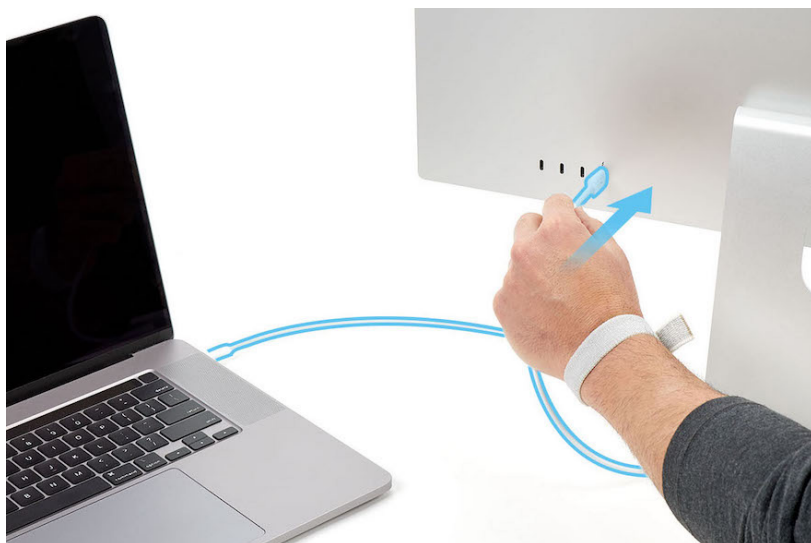

Caution

- After you've completed all removal and reassembly steps, learn how to initiate the System Configuration process at support.apple.com/self-service-repair.
- If you replaced the display, the display's brightness, True Tone, and Center Stage may not function properly until you complete System Configuration.
- If you replaced the logic board, an alert symbol and "support.apple.com/display/restore" will appear on your screen until you complete System Configuration.

Display (VESA Mount Adapter)

Before You Begin

Danger

Ensure that the power cord is not plugged into an electrical outlet.

Warning

Read [Broken Glass Safety](#) before you begin.

Caution

- Two people need to perform some of the removal and reassembly steps.
- Some images show the power cord removed from the display, but during this procedure, the power cord should remain connected to the display.

Tools

- Adhesive cutter
- Adhesive cutter replacement wheels
- Display adhesive strips
- Display support stand
- ESD-safe tweezers
- Ethanol wipes or IPA wipes
- Microfoam bag
- Nylon probe (black stick)
- Safety glasses
- Silicone roller
- Sticky sheet pad
- Support foam rest blocks
- Support wedge: tilt-adjustable stand
- Support wedge: tilt- and height-adjustable stand

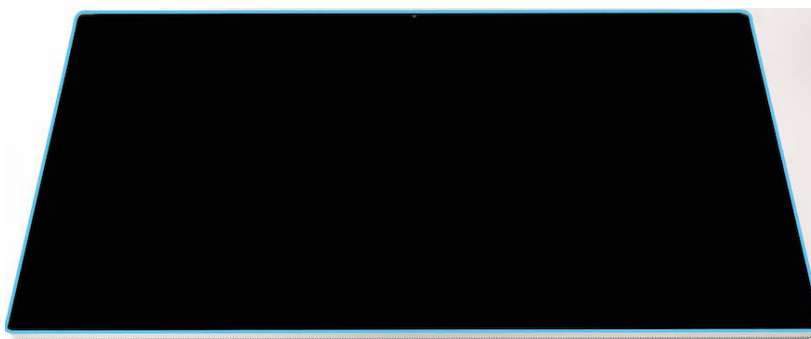

Caution

This procedure requires System Configuration. To perform System Configuration you will need the following:

- The latest version of [Apple Service Utility](#) installed on a Mac running macOS 12.4 or later
- Internet access
- A USB-C charge cable or a USB-A to USB-C cable. The USB-C cable must support both power and data. Don't use Thunderbolt 3 cables.

After you've completed all removal and reassembly steps and configured the Mac with Apple Service Utility, learn how to initiate the System Configuration process at support.apple.com/self-service-repair.

Caution

The adhesive cutter has replacement wheels. You will likely need to use several wheels because when a wheel is chipped, dented, broken, or no longer flat, you must replace it. Using a damaged wheel can damage the polyester tape on the display.

Damaged wheel



New wheel



Important

- To remove the display, you must cut adhesive strips that attach the display to the rear housing. Each strip has a foam layer surrounded by two adhesive layers. You'll use the adhesive cutter to cut the adhesive strips and will be cutting mostly through the foam layer.
- For models configured with the tilt-adjustable stand or tilt- and height-adjustable stand, refer to the [Display \(Stand\)](#) removal and reassembly instructions.

Note: The images in this procedure may show a display with a stand. However, the procedure is the same for a display with a VESA mount adapter.

Removal

1. Place the display flat on the large foam blocks with the display faceup. Cut the display adhesive strips by inserting the adhesive cutter between the display and the housing. Start from a corner, and move the wheel around the edges of the display.



2. Move your fingers along the edge of the display to check that the adhesive has been sufficiently cut. If the adhesive is not completely cut, use the adhesive cutter to cut any remaining adhesive.
3. Stand up the display with the top of the housing (camera side) on the table.

4. Place the support tilt wedge and support lift wedge in front of the display.

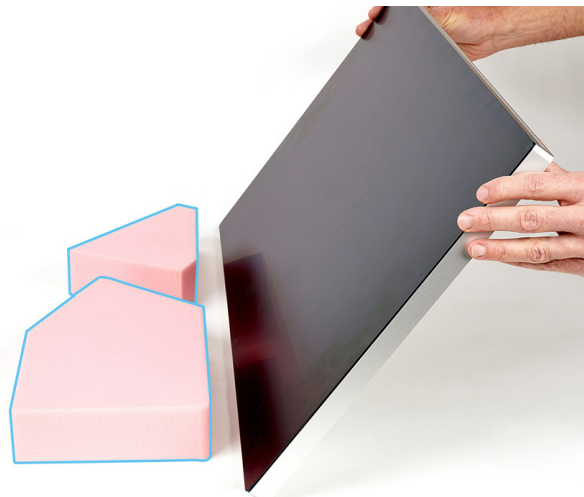

 **Caution**

You will need another person to assist you to complete steps 5 through 10.

5. Have another person hold the housing from the back. Then carefully separate the display from the housing starting from the bottom (non-camera) side.



6. Carefully separate the remainder of the display from the housing. When the display is separated from the hangers in the housing, lift up the display assembly and rest it on the support lift wedge and support tilt wedge.



7. Pull the tab to flip up the locking bar on the DisplayPort signal flex cable (1). Then slide the end of the flex cable out of the connector (2).

Important

The DisplayPort signal flex cable has a small area of adhesive that adheres to the back of the display. If the flex cable is still adhered to the back of the display, use the black stick to release it.

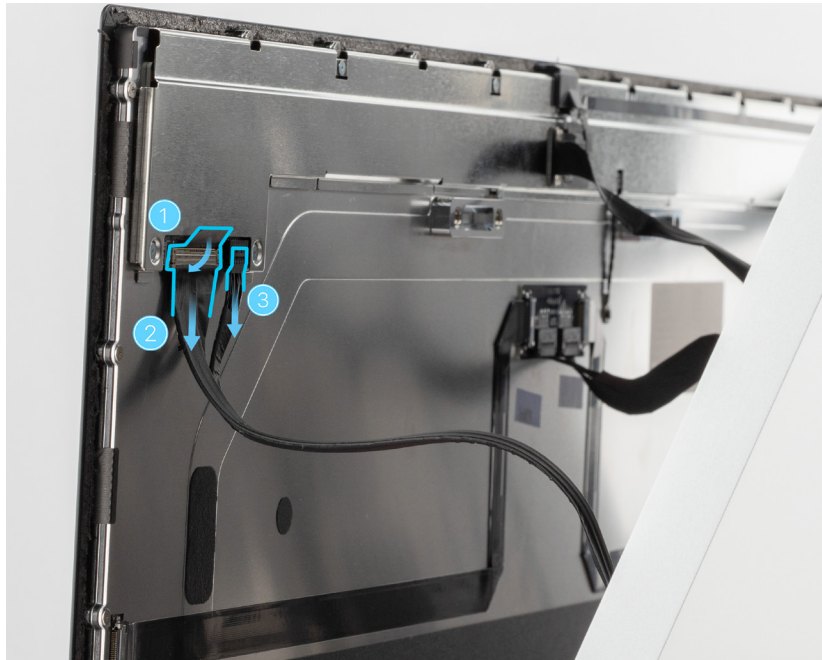

8. Slide the end of the DisplayPort power cable out of the connector (3).

9. Pull the tab to flip up the locking bar (1) on the camera flex cable. Then slide the end of the flex cable out of the connector (2).

10. Gently wiggle the ends of the display backlight cables out of the connectors (3).

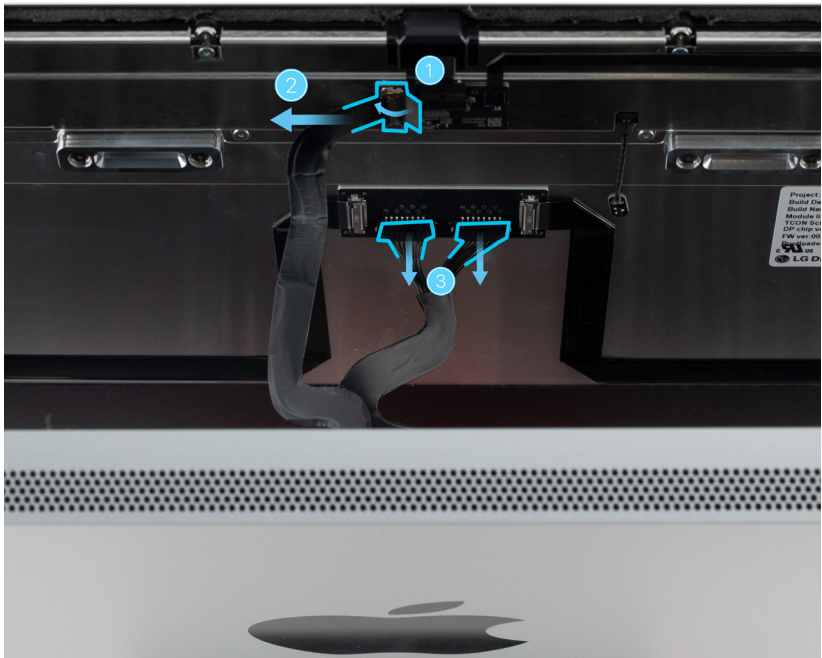

11. Set the display on the display support stand.

Important

If you don't have a display support stand, lay the display facedown on a clean, soft towel. To avoid damage to the display, ensure that the flex cables don't touch the towel.

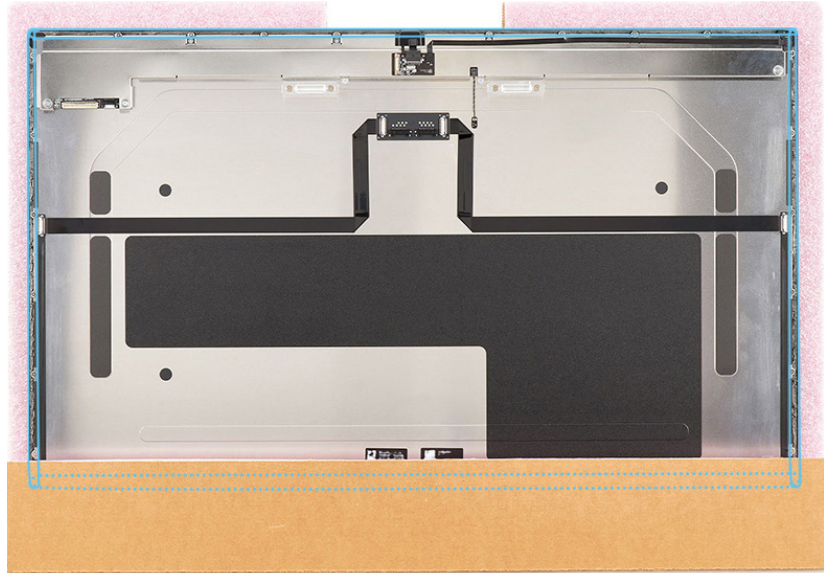

12. Use ESD-safe tweezers to peel the display adhesive from the back of the display as shown.



Caution

- To prevent damage to the polyester film on the display, don't peel the display adhesive from the corners of the display.
- Don't use ethanol wipes or IPA wipes on the display. Ethanol or isopropyl alcohol may damage the polyester film.

13. Use ESD-safe tweezers to peel the display adhesive from the edges of the housing as shown.

14. Use ethanol wipes or IPA wipes to clean any remaining adhesive from the housing.

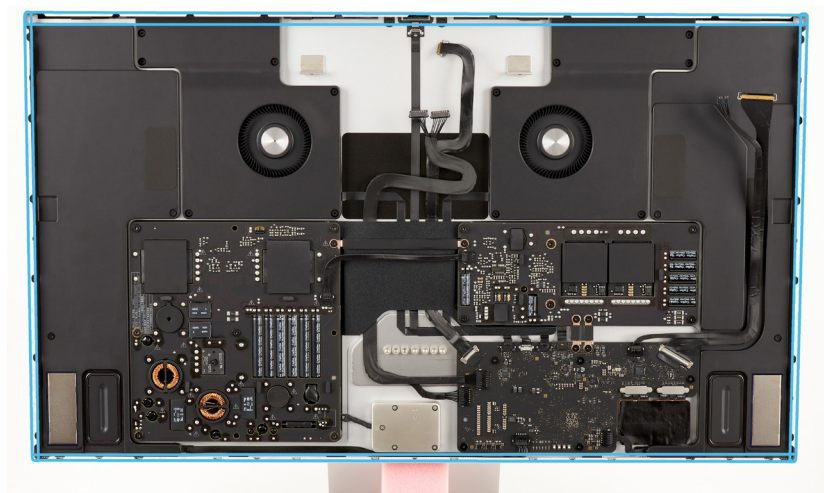

Reassembly

1. Place the display adhesive strips on a flat surface and check them for damage and wrinkles. Refer to the part numbers on the adhesive strips to identify the correct position of the adhesive strips:

- Bottom (946-21413) (1)
- Upper left (946-21414) (2)
- Upper right (946-21415) (3)
- Right (946-21416) (4)
- Left (946-21417) (5)

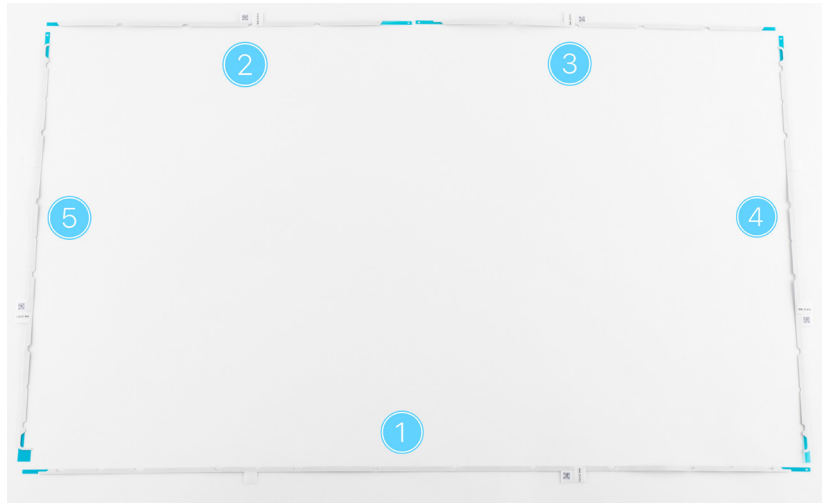

Caution

Damaged display adhesive strips can cause cosmetic gaps and light leakage. They can also weaken the bond between the display and the housing. If the adhesive strips are wrinkled or damaged, replace them.

Note: The display adhesive strips have two layers of adhesive with a foam layer between them. There is a paper release liner on the underside and a plastic release liner on the top. The colors of the release liners may vary.

2. Place the housing on the foam blocks with the interior face up.

3. Peel off sections of the paper release liner from the left adhesive strip as you press the adhesive strip to the edge of the housing. Then use the flat end of the black stick to firmly press along the length of the adhesive strip to adhere it to the housing.



Important

Ensure that you match the display adhesive strip pattern to the housing pattern.

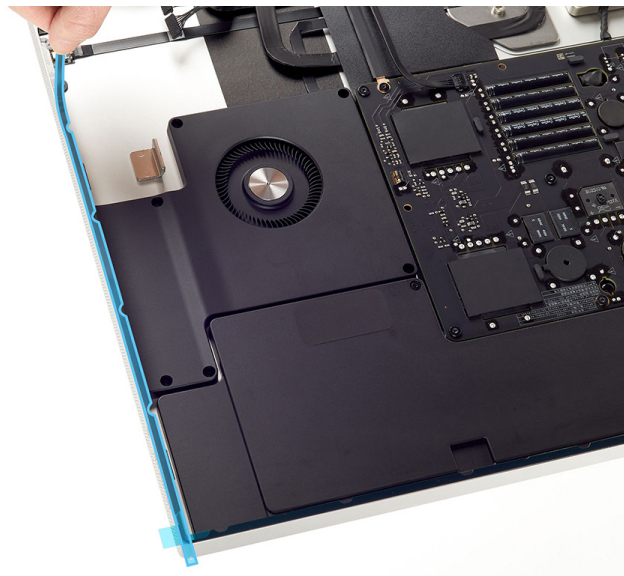

4. Repeat step 3 to install the adhesive strips on the right, upper left, upper right, and the bottom edges of the housing. Then continue to step 5.

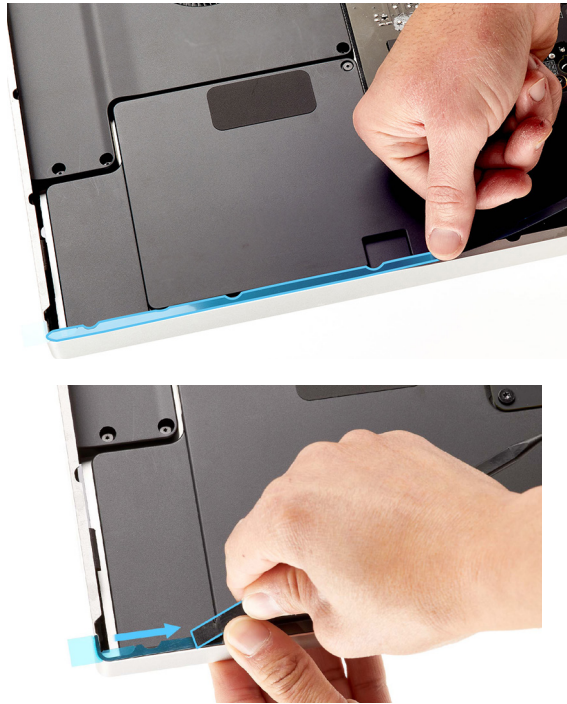

 **Caution**

You will need another person to assist you to complete steps 5 through 12.

5. Have another person stand up the housing with the top of the housing (camera side) on the table. Place the support lift wedge and support tilt wedge in front of the housing.

6. Lift the display assembly up and rest it on the support lift wedge and support tilt wedge.



7. Slide the ends of the display backlight cables (1) into the connectors.
8. Slide the end of the camera flex cable into the connector (2). Then flip down the locking bar on the flex cable (3).

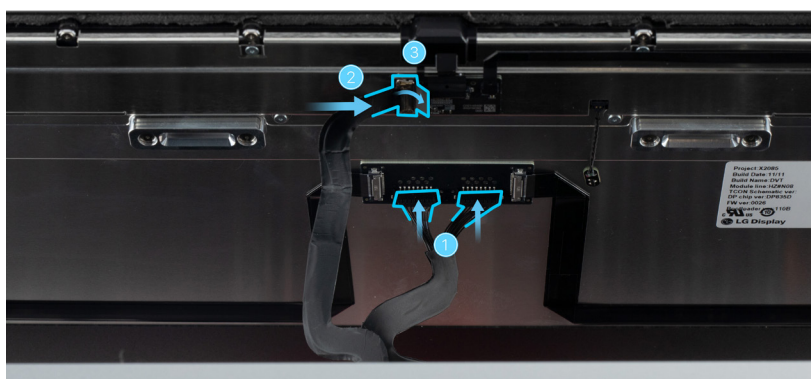

9. Slide the end of the DisplayPort power cable into the connector (1).
10. Slide the end of the DisplayPort signal flex cable into the connector (2). Then flip down the locking bar on the flex cable (3).

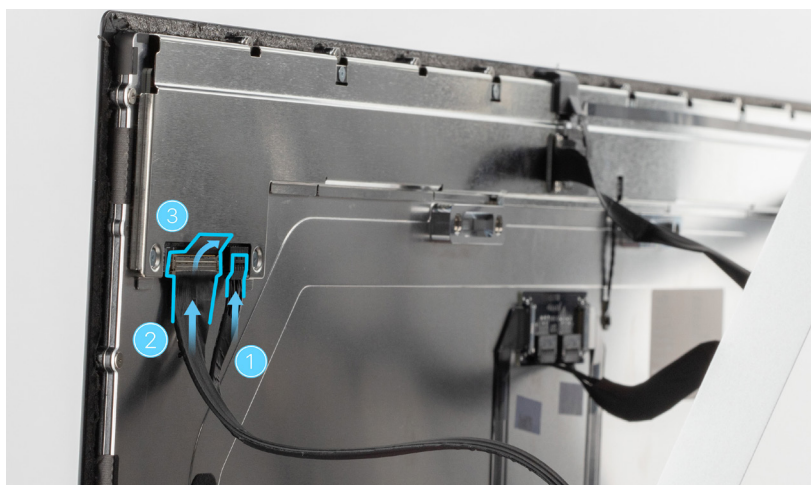

11. Place the display in the housing by aligning the edges.

12. Place the two support foam rest blocks on the table with the lines in the blocks running vertical as shown. Place the housing on the foam blocks with the display side faceup.



13. Separate the display just enough to remove the release liner from the bottom edge of the display. Repeat the motion along the perimeter of the display until the release liners are removed from the left, right, and top edges.

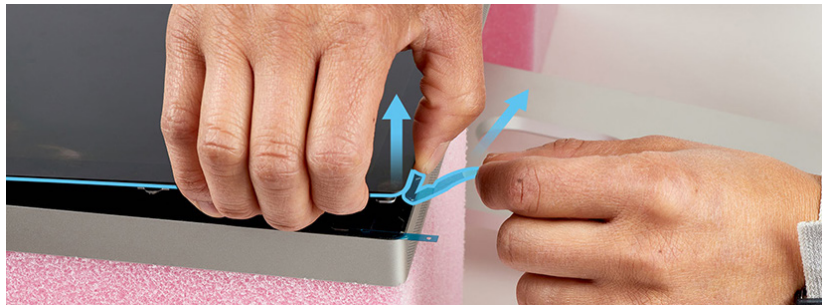

14. Remove the liner from the sticky sheet pad. Roll the silicone roller back and forth on the sticky sheet pad to clean it.



15. Roll the silicone roller across each edge of the display six times.

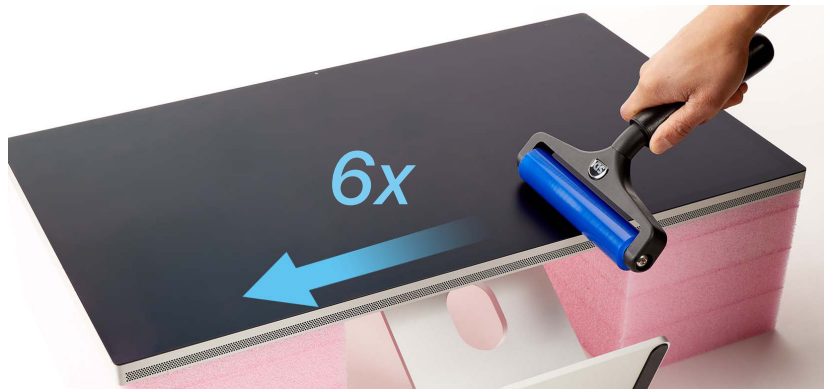

16. Use both hands to press the edge of the display and help set the adhesive. Move your hands along the edge of the display, pressing at each location.



17. Place the display in the microfoam bag. Then place it flat on a clean table with the display side facedown. Wait 30 minutes for the adhesive to attach to both the display and the housing.



 **Caution**

Don't drag the display on the table.

18. Remove the display from the microfoam bag.

Important

- If you reinstalled the existing display or logic board, the repair is complete.
- If you replaced the display or logic board, complete steps 19 through 21. Ensure that you have a Mac with [Apple Service Utility](#) installed and a USB-C charge cable before you continue.

19. Open the Apple Service Utility app on the Mac. Ensure that all Resources have been installed.

Note: The time to download and install Resources will vary based on your network connection speed to the internet.



20. Plug the display power cord into an electrical outlet.

21. Plug one end of the USB-C charge cable into the Mac. Then plug the other end of the USB-C charge cable into the Thunderbolt 3 port on the back of the display. The Thunderbolt 3 port is the rightmost port.



Caution

- After you've completed all removal and reassembly steps, learn how to initiate the System Configuration process at support.apple.com/self-service-repair.
- If you replaced the display, the display's brightness, True Tone, and Center Stage may not function properly until you complete System Configuration.
- If you replaced the logic board, an alert symbol and "support.apple.com/display/restore" will appear on your screen until you complete System Configuration.

Logic Board

Before You Begin



Ensure that the power cord is not plugged into an electrical outlet.

Remove the following parts before you begin:

- [Display \(stand\)](#) or [display \(VESA mount adapter\)](#)
- [USB-C boards](#)

Tools

- Adjustable torque driver (10–34 Ncm)
- Adjustable torque driver torque driver (0.3–1.2 Nm)
- Alignment pins (2 mm)
- ESD-safe tweezer
- Nylon probe (black stick)
- Support wedge for tilt-adjustable stand
- Support wedge for tilt- and height-adjustable stand
- Torx T6 bit
- Torx T6 screwdriver



This procedure requires System Configuration. To perform System Configuration you will need the following:

- The latest version of [Apple Service Utility](#) installed on a Mac running macOS 12.4 or later
- Internet access
- A USB-C charge cable or a USB-A to USB-C cable. The USB-C cable must support both power and data. Don't use Thunderbolt 3 cables.

After you've completed all removal and reassembly steps and configured the Mac with Apple Service Utility, learn how to initiate the System Configuration process at support.apple.com/self-service-repair.

Removal

Important

Ensure that the support wedge is between the housing and the stand to keep the display in place.

1. Pinch the sides of the ends of the five cables and slide them out of the connectors (1).
2. Pull the tabs to flip up the locking bars on the two flex cables (2). Then slide the ends of the two flex cables out of the connectors.
3. Use ESD-safe tweezers to peel back the polyester film tabs on the three locking lever connectors (3). Use the flat end of the black stick to flip up the three locking levers. Then slide the three flex cables out of the connectors.
4. Use the flat end of the black stick to press and hold the "PUSH" button on the zero-insertion force (ZIF) connector (4) and use ESD-safe tweezers to slide the end of the flex cable out of the connector.

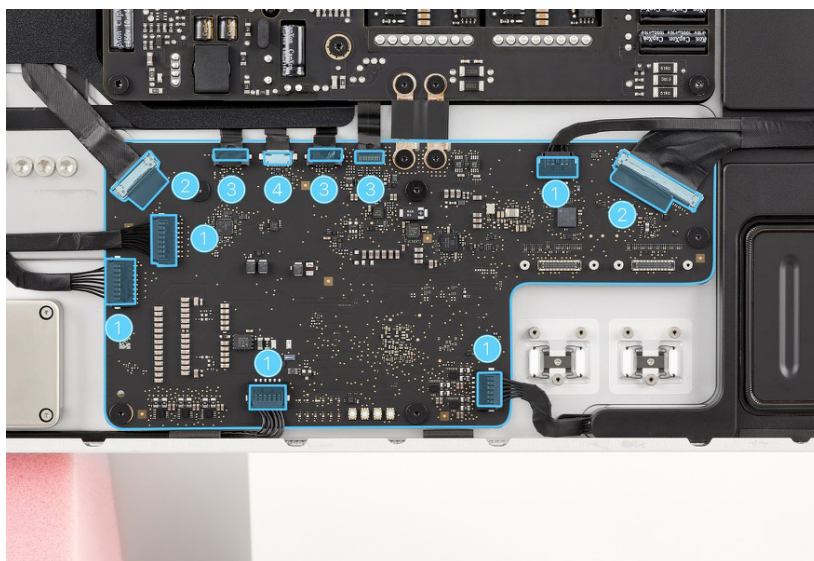

5. Use the T6 screwdriver to remove the four T6 screws (923-07141) from the logic board bus bar. Then remove the bus bar.

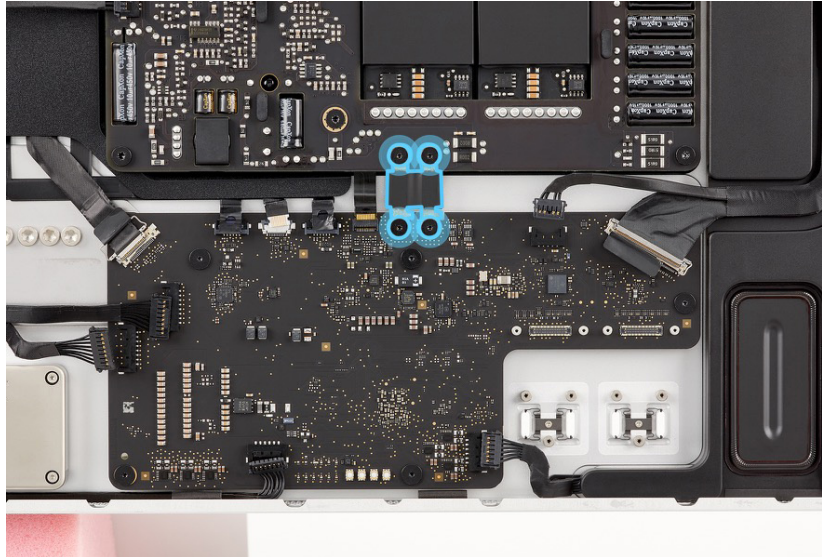

6. Use the T6 screwdriver to remove the five T6 screws (923-07142) from the logic board.

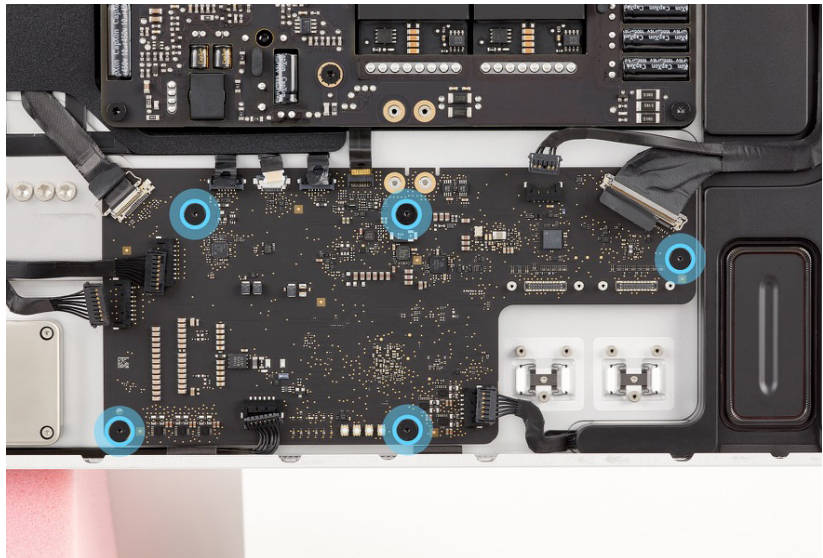

7. Use the black stick to move the cables out of the way as you lift the logic board out of the housing.

Reassembly

1. Install the two 2 mm alignment pins as shown.

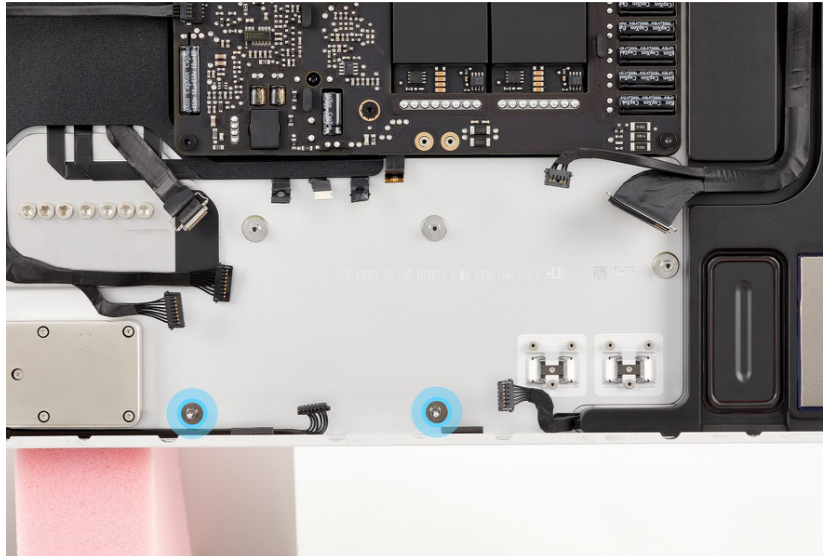

2. Use the two 2 mm alignment pins to position the logic board into the housing while using the black stick to move the cables out of the way.

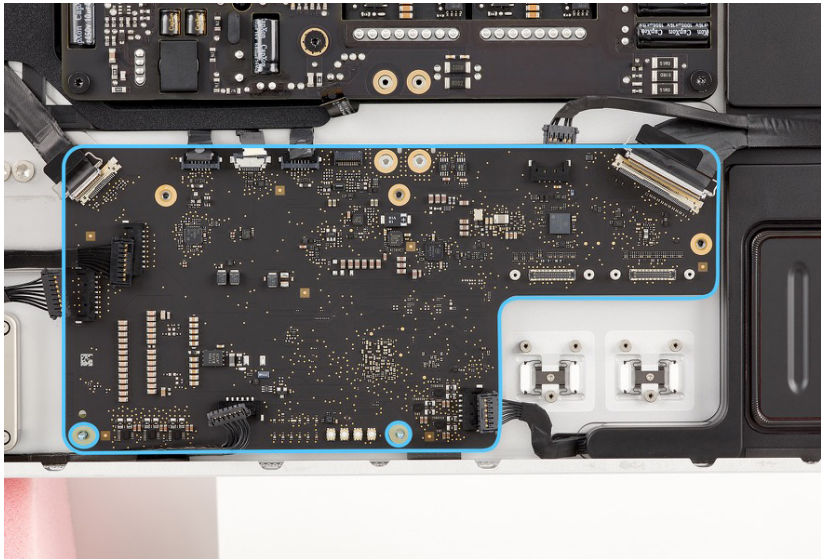

3. Use the T6 screwdriver to partially reinstall three T6 screws (923-07142) as shown.
4. Insert the Torx T6 bit into the 0.3–1.2 Nm adjustable torque driver. Set the torque value to 0.4 Nm.
5. Use the adjustable torque driver and T6 bit to fully reinstall the three T6 screws.

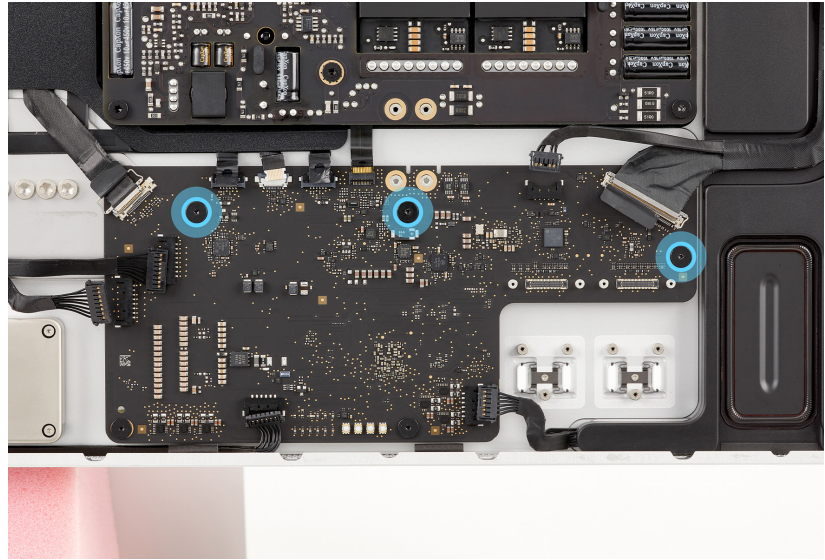

6. Remove the two 2 mm alignment pins. Then use the T6 screwdriver to partially reinstall two T6 screws (923-07142) as shown.
7. Keep the Torx T6 bit in the 0.3–1.2 Nm adjustable torque driver. Ensure that the torque value is still set to 0.4 Nm.
8. Use the adjustable torque driver and the T6 bit to fully reinstall the two T6 screws.

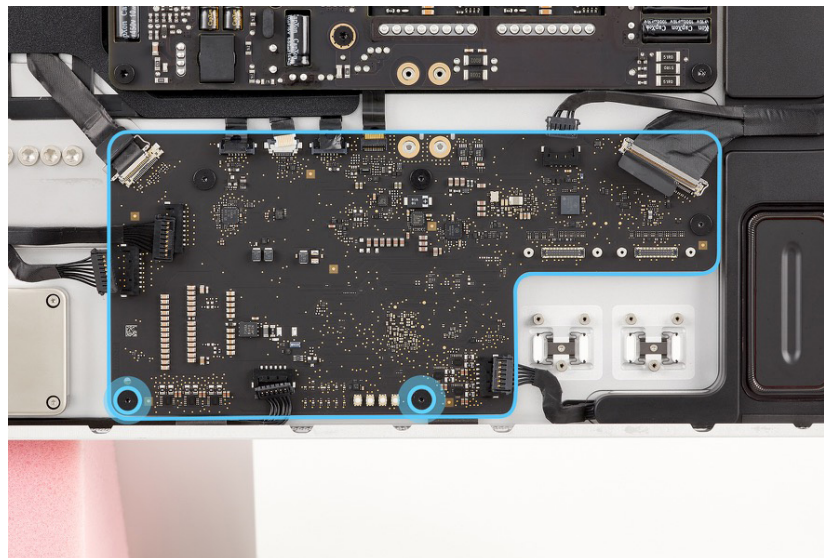

- Position the logic board bus bar on the logic board and the power supply board. Use the T6 screwdriver to partially reinstall the four T6 screws (923-07141).

Important

Ensure that the hooks on the bus bar align with the notches in the logic board.

- Insert the Torx T6 bit into the 10–34 Ncm torque driver. Set the torque value to 20.5 Ncm. Use the adjustable torque driver and T6 bit to fully reinstall the four T6 screws.

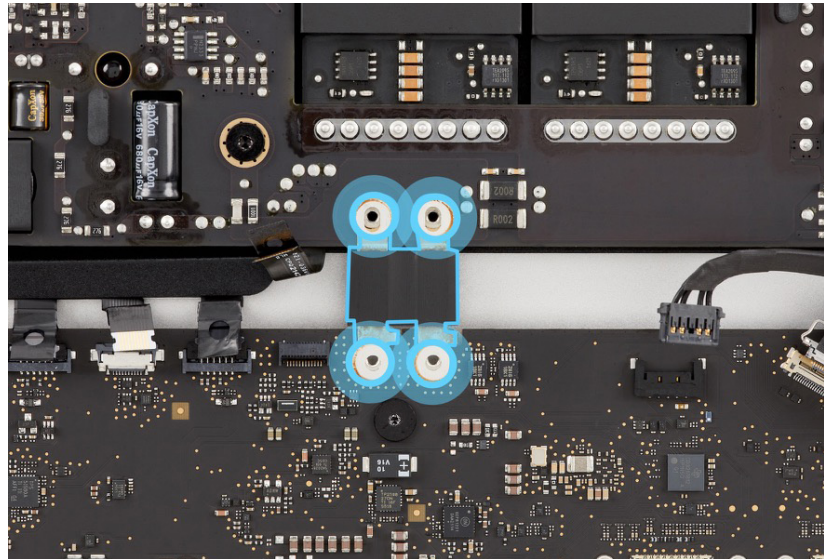

- Slide the end of the ZIF flex cable into the connector (1). Ensure that the cable is fully inserted.

- Slide the ends of the three locking lever flex cables into the connectors (2). Then use the black stick to flip down all three locking levers. Press the polyester film tabs to adhere them to the flex cables.

- Slide the ends of the two locking bar flex cables into the connectors (3). Then use the black stick to flip down the locking bars.

- Slide the ends of the five cables into the connectors (4).

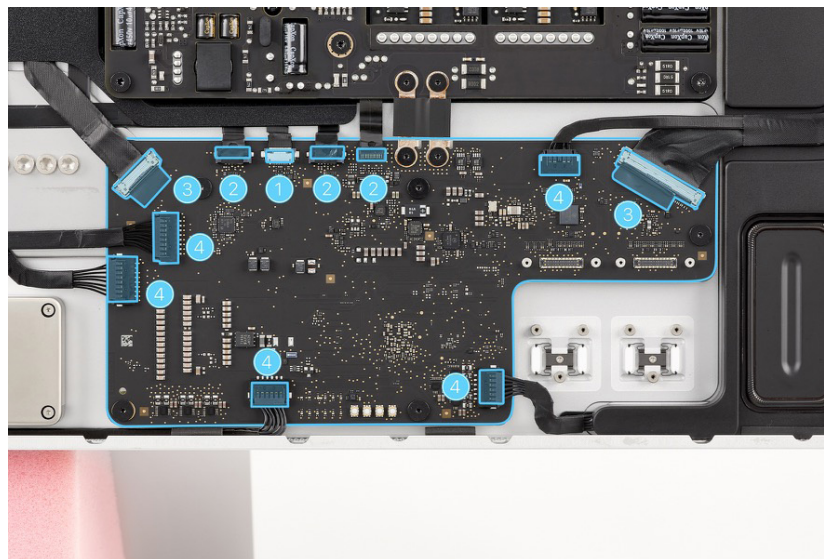

Reinstall the following parts to complete reassembly:

- [USB-C boards](#)
- [Display \(stand\)](#) or [display \(VESA mount adapter\)](#)

 **Caution**

- After you've completed all removal and reassembly steps, learn how to initiate the System Configuration process at support.apple.com/self-service-repair.
- If you replaced the logic board, the screen will show an alert symbol and "support.apple.com/display/restore" until you complete System Configuration. You will need a separate Mac with [Apple Service Utility](#) installed to perform System Configuration.

Left Fan

Before You Begin



Ensure that the power cord is not plugged into an electrical outlet.

Remove the following part before you begin:

- [Display \(stand\)](#) or [display \(VESA mount adapter\)](#)

Tools

- Adjustable torque driver (10–34 Ncm)
- ESD-safe tweezers
- Nylon probe (black stick)
- Support wedge for tilt-adjustable stand
- Support wedge for tilt- and height-adjustable stand
- Torx T5 bit
- Torx T5 screwdriver

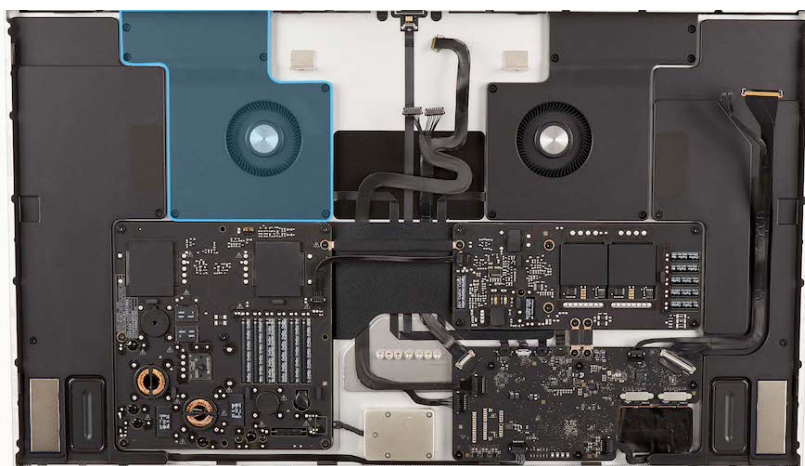

Removal

Important

Ensure that the support wedge is between the housing and the stand to keep the display in place.

1. Use the T5 screwdriver to remove the six T5 screws (923-07140) from the fan.

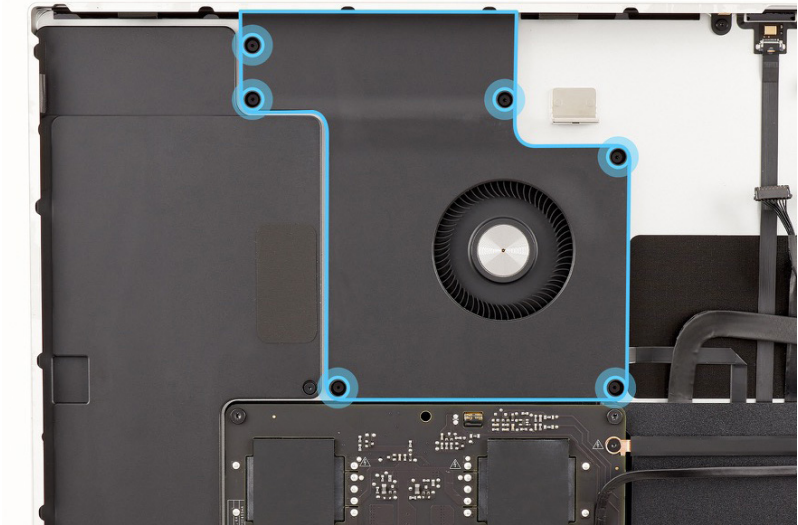

2. Use the black stick to gently release the adhesive between the fan flex cable and the housing as shown.

Note: Releasing the adhesive provides more space to disconnect the cable from the back of the fan.



3. Lift the fan from the bottom away from the speaker.

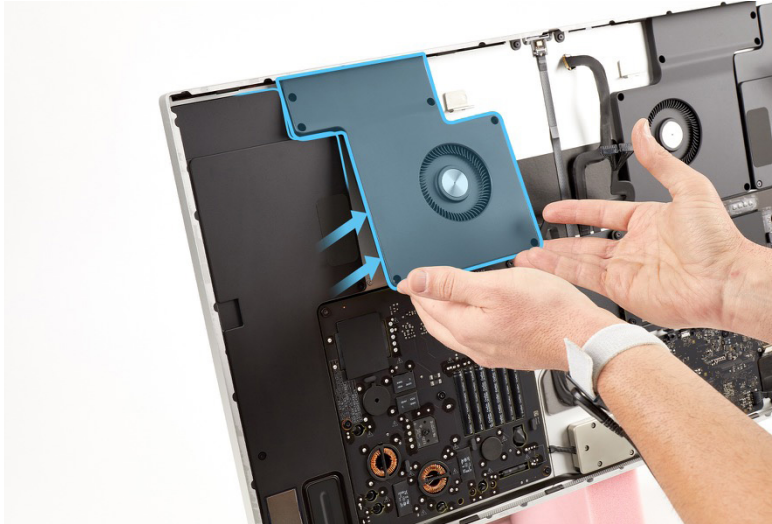

4. Lower the fan away from the top housing.



5. Rotate the fan to directly access to the fan flex cable connector.

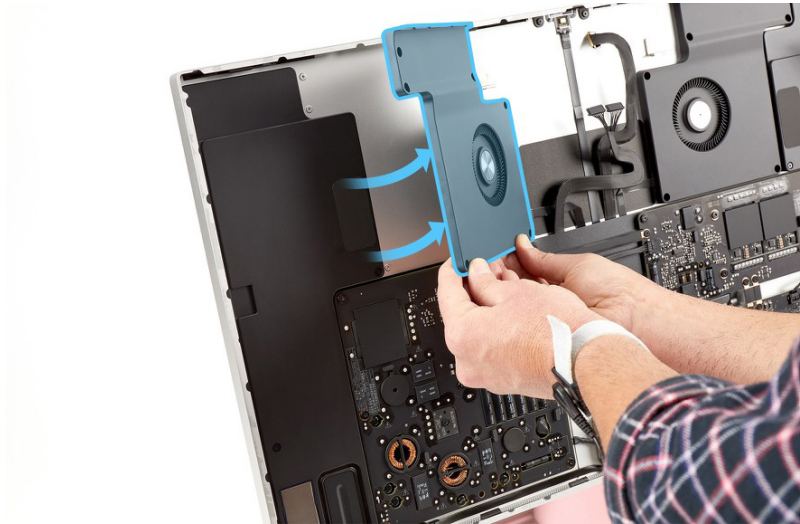

6. Use ESD-safe tweezers to peel back the adhesive cover on the fan flex cable connector. Then use the black stick to flip up the locking lever.



7. Slide the end of the fan flex cable out of the connector. Then remove the fan from the housing.



Reassembly

1. Position the fan so the fan flex cable can reach the connector on the back of the fan. Then slide the end of the flex cable into the connector.



2. Use the black stick to flip down the locking lever on the fan flex cable. Reapply the adhesive cover. Then rotate the fan toward the housing.

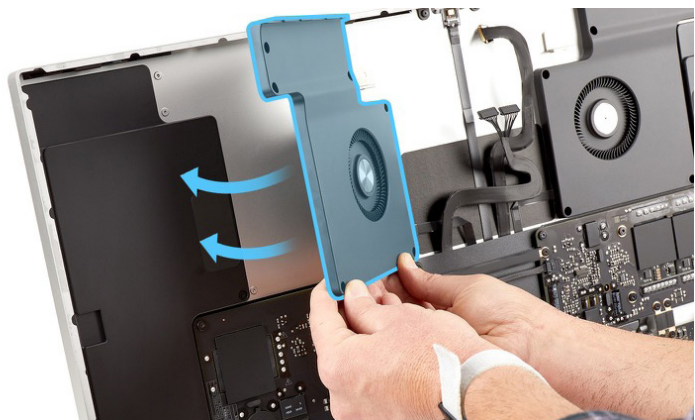

3. Insert the fan into the housing from the top.



4. Position the top part of the fan next to the speaker. Then position the lower part of the fan into the housing.

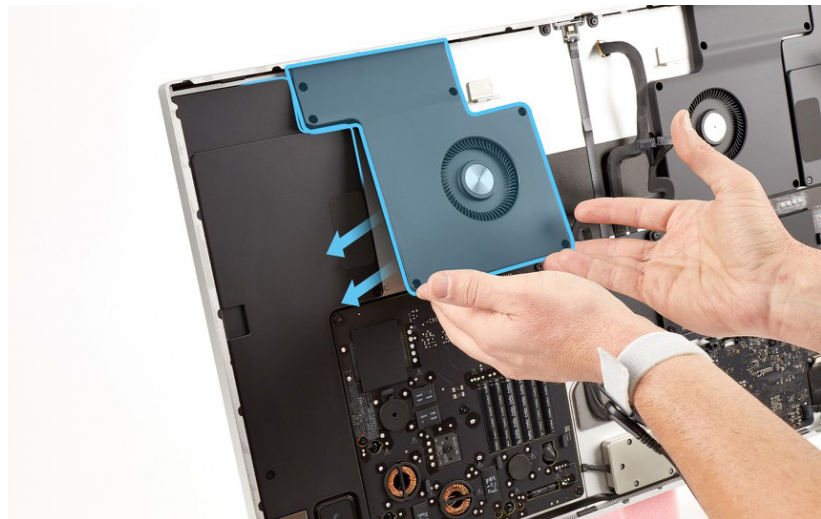

5. Use the T5 screwdriver to partially reinstall the six T5 screws (923-07140).

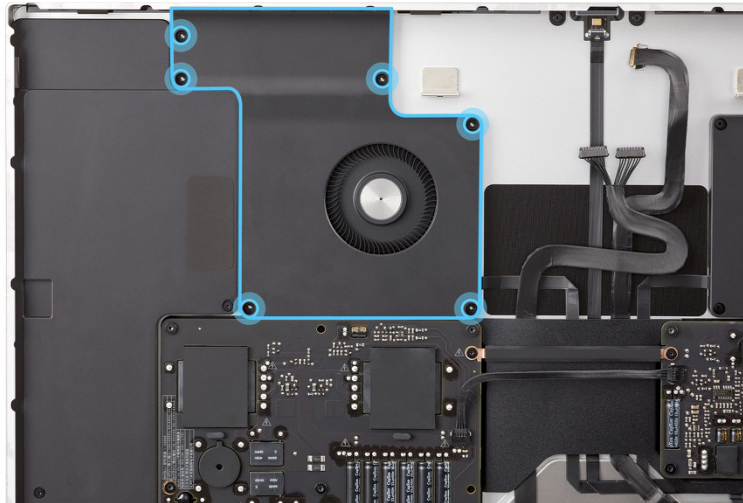

6. Insert the Torx T5 bit into the 10–34 Ncm adjustable torque driver. Set the torque value to 17.5 Ncm.
7. Use the adjustable torque driver and Torx T5 bit to fully reinstall the six T5 screws.

8. Press the fan flex cable to adhere it to the housing.

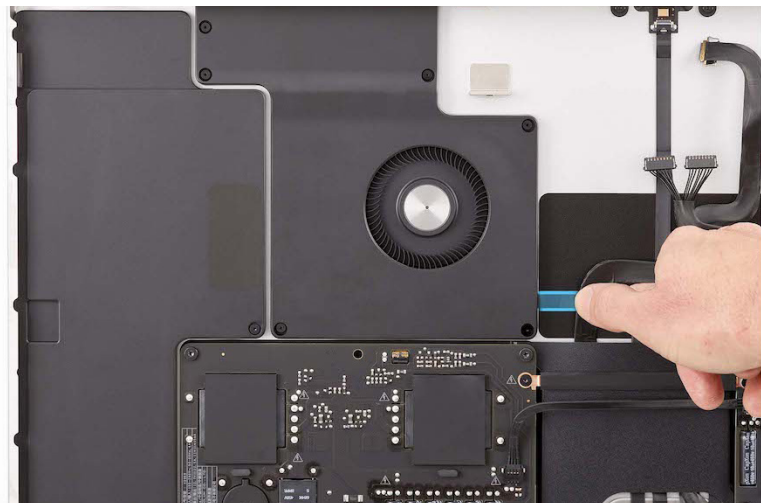

Reinstall the following parts to complete reassembly:

- [Display \(stand\)](#) or [display \(VESA mount adapter\)](#)

Right Fan

Before You Begin



Ensure that the power cord is not plugged into an electrical outlet.

Remove the following part before you begin:

- [Display \(stand\)](#) or [display \(VESA mount adapter\)](#)

Tools

- Adjustable torque driver (10–34 Ncm)
- ESD-safe tweezers
- Nylon probe (black stick)
- Support wedge for tilt-adjustable stand
- Support wedge for tilt- and height-adjustable stand
- Torx T5 bit
- Torx T5 screwdriver



Removal

Important

Ensure that the support wedge is between the housing and the stand to keep the display in place.

1. Use the T5 screwdriver to remove the six T5 screws (923-07140) from the fan.

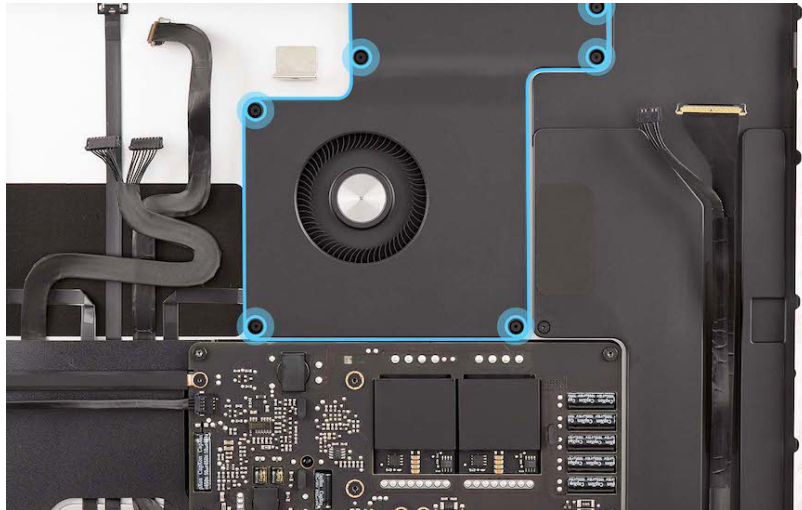

2. Use the black stick to gently release the adhesive between the fan flex cable and the housing as shown.

Note: Releasing the adhesive provides more space to disconnect the cable from the back of the fan.

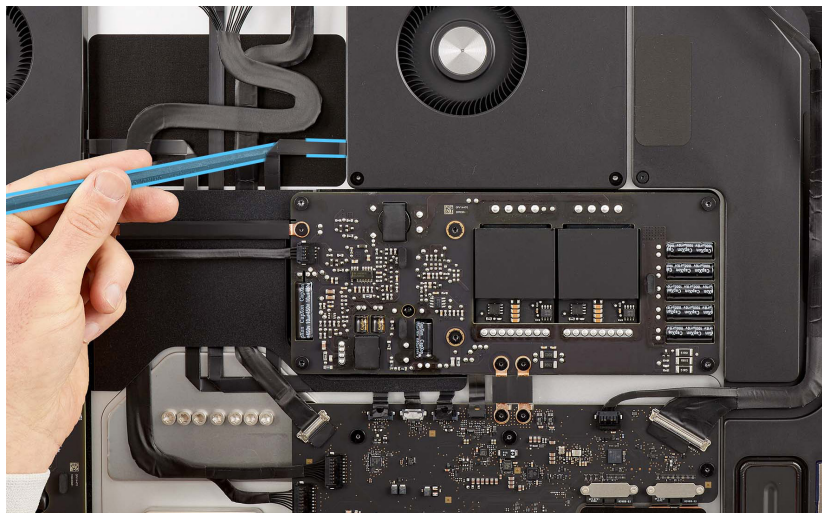

3. Lift the fan from the bottom away from the speaker.



4. Lower the fan away from the top housing.

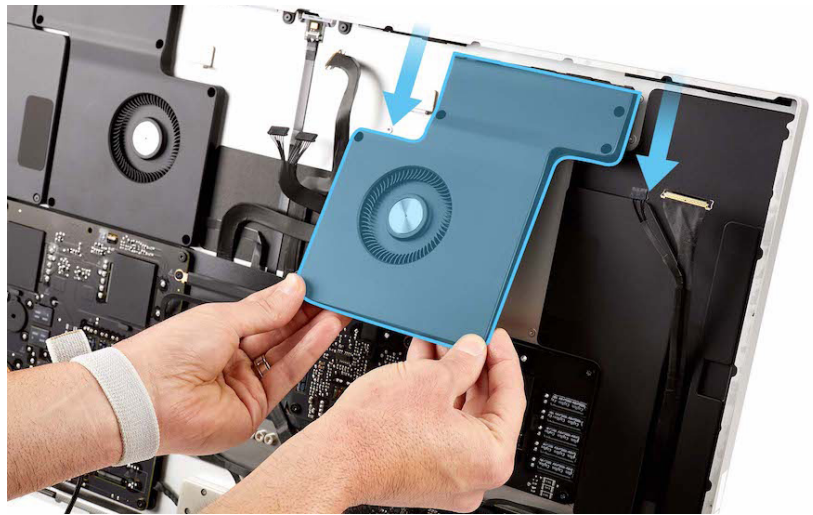

5. Rotate the fan to directly access to the fan flex cable connector.



6. Use ESD-safe tweezers to peel back the adhesive cover on the fan cable connector. Then use the black stick to flip up the locking lever.



7. Slide the end of the fan flex cable out of the connector. Then remove the fan from the housing.



Reassembly

1. Position the fan so the fan flex cable can reach the connector on the back of the fan. Then connect the fan flex cable to the connector.

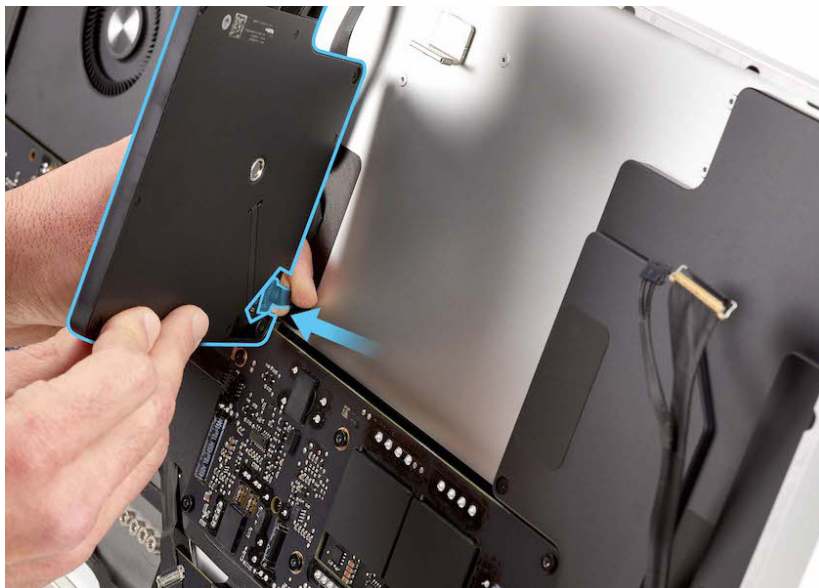

2. Use the black stick to flip down the locking lever on the fan flex cable. Reapply the adhesive cover. Then rotate the fan toward the housing.

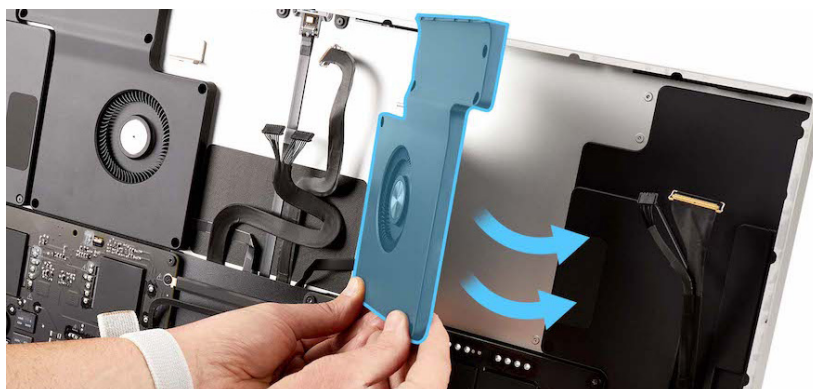

3. Insert the fan into the housing from the top.

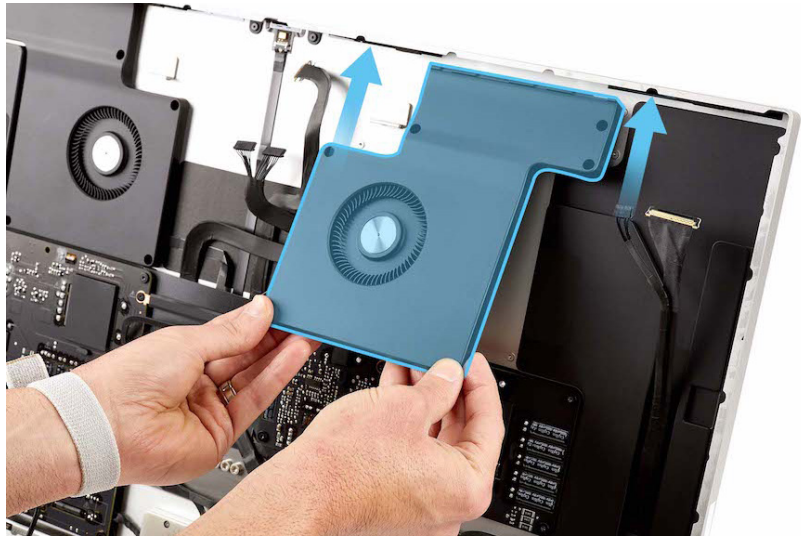

4. Position the top part of the fan next to the speaker. Then position the lower part of the fan into the housing.



5. Use the T5 screwdriver to partially reinstall the six T5 screws (923-07140).

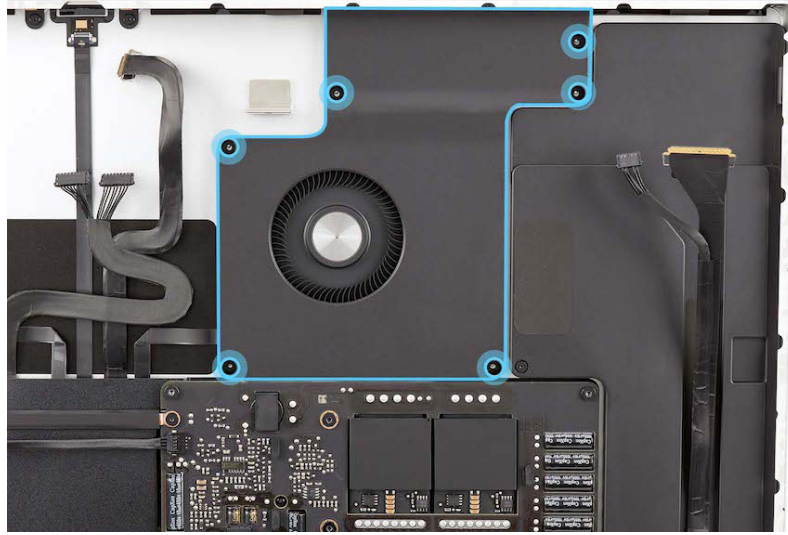

6. Insert the Torx T5 bit into the 10–34 Ncm adjustable torque driver. Set the torque value to 17.5 Ncm.
7. Use the adjustable torque driver and Torx T5 bit to fully reinstall the six T5 screws.

8. Press the fan flex cable to adhere it to the housing.



Reinstall the following part to complete reassembly:

- [Display \(stand\)](#) or [display \(VESA mount adapter\)](#)

USB-C Boards

Before You Begin



Ensure that the power cord is not plugged into an electrical outlet.

Remove the following part before you begin:

- [Display \(stand\)](#) or [display \(VESA mount adapter\)](#)

Tools

- ESD-safe tweezers
- Nylon probe (black stick)
- Support wedge for tilt-adjustable stand
- Support wedge for tilt- and height-adjustable stand
- Torx T3 screwdriver



Removal

Important

Ensure that the support wedge is between the housing and the stand to keep the display in place.

1. Use the T3 screwdriver to remove the four T3 screws (923-05561) from the USB-C board connector cowlings. Then remove the two cowlings and save them for reassembly.

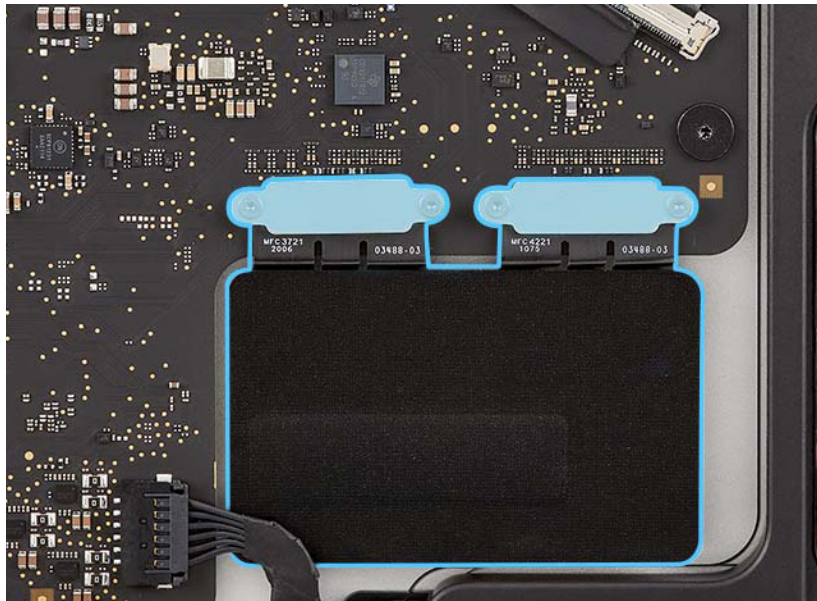

2. Use the black stick to lift the ends of the two flex cables off the connectors.

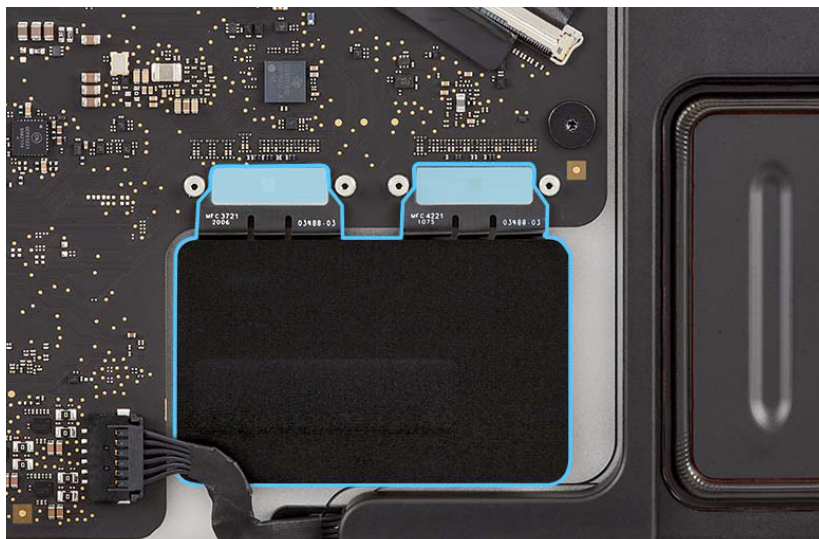

3. Use the ESD-safe tweezers to peel the top layer of the polyester film tape from the USB-C boards, starting from the bottom-right corner.

Note: If you plan to reinstall the existing USB-C boards, save the tape for reassembly.

Important

Don't remove the adhesive layers directly attached to each of the USB-C boards.

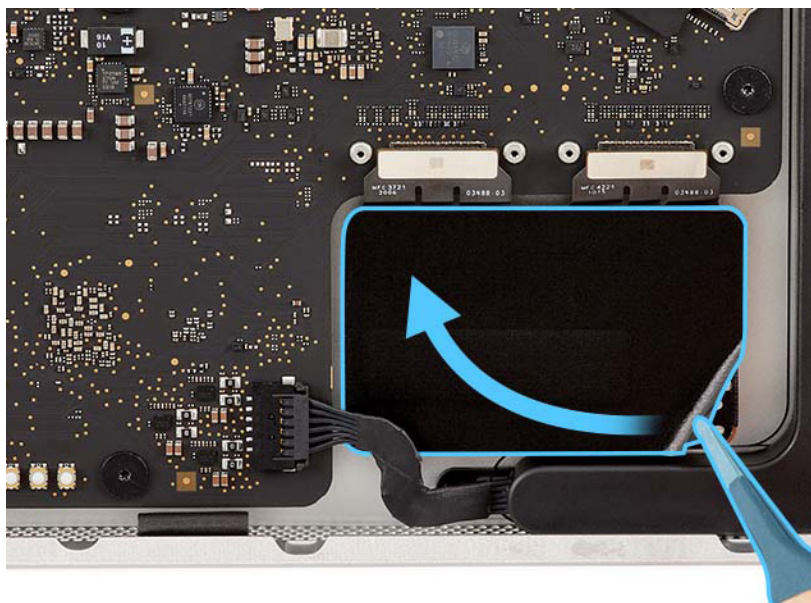

4. Use the T3 screwdriver to remove the six T3 screws (923-07144). Then use the black stick to remove the boards from the housing.

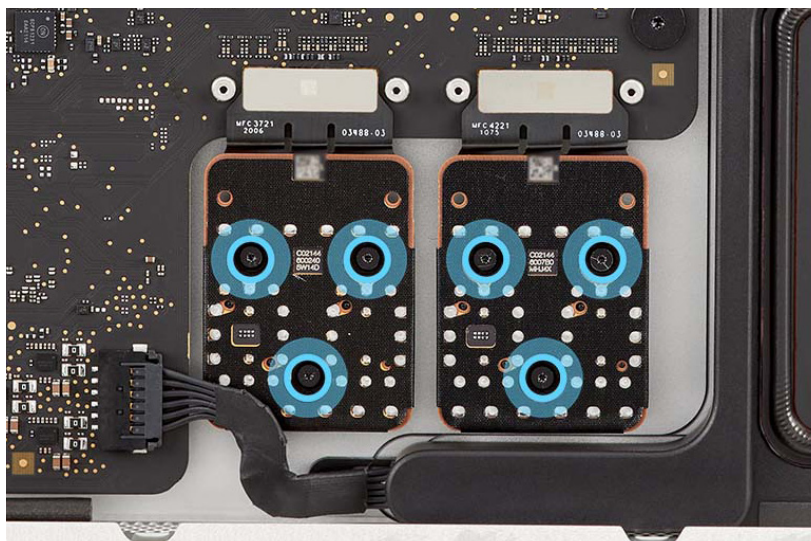

Reassembly

Important

The USB-C boards are marked L and R near the barcode to indicate their position. The markings may be different than the image. Failure to install the boards in the correct positions will prevent the display from connecting to a Mac.

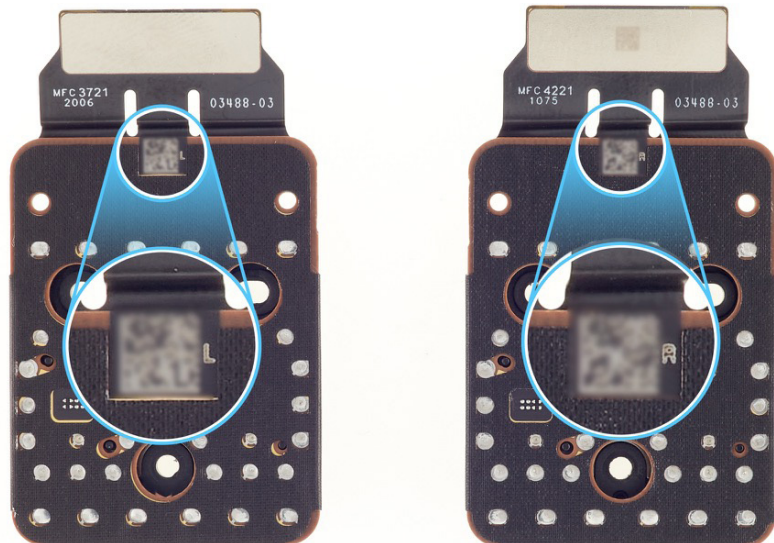

1. Position the left and right USB-C boards in the housing. Then gently press them into place.
2. Use the T3 screwdriver to reinstall the six T3 screws (923-07144).

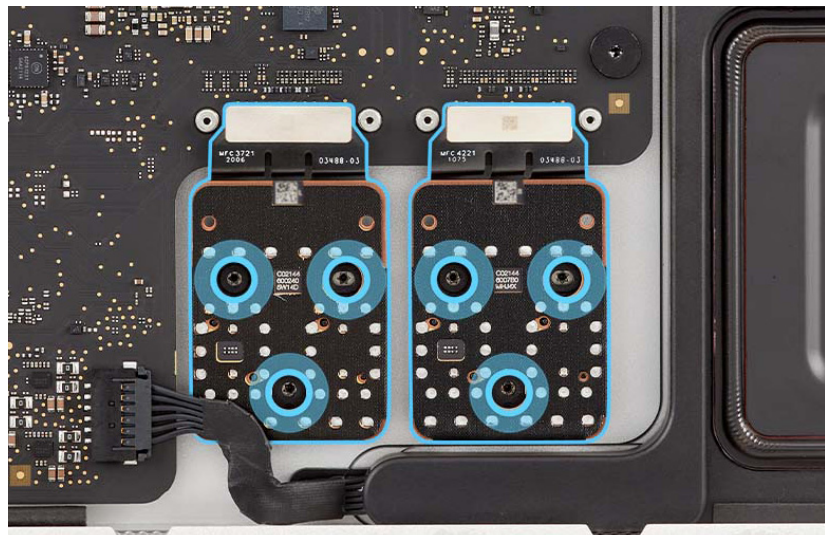

3. If you're replacing the USB-C boards, peel the polyester film tape from the adhesive backing. If you're reinstalling the existing USB-C boards, skip to reassembly step 4.

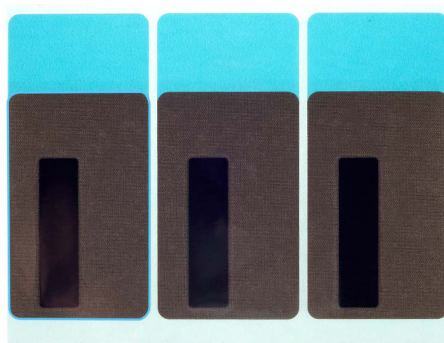

4. Position the polyester film tape over both USB-C boards as shown, starting from the top left corner. Run the flat end of the black stick along the length of the polyester film tape.

Important

Position the polyester film tape so that the protective strip is in the bottom left corner. Use the black stick to adhere the polyester film tape behind the right speaker cable.

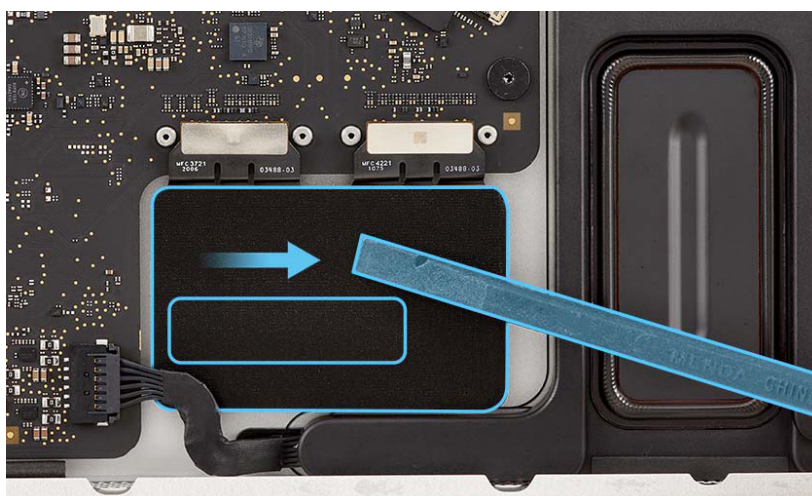

5. Press the ends of the two flex cables to the connectors.

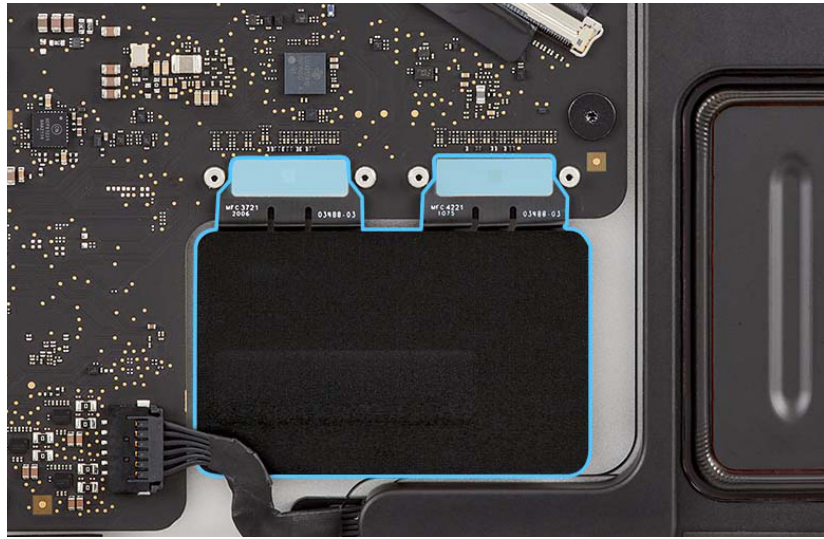

6. Position the two USB-C board connector cowlings over the ends of the two flex cables. Use the T3 screwdriver to reinstall the four T3 screws (923-05561).

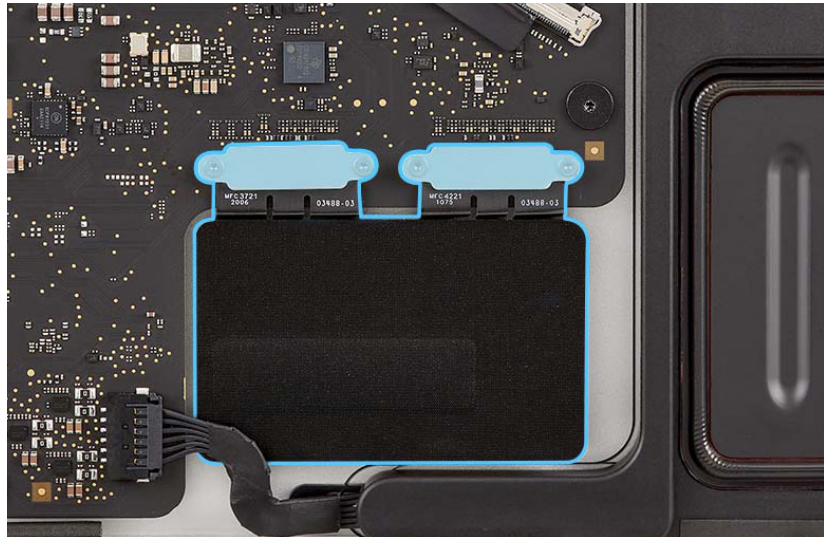

Reinstall the following part to complete reassembly:

- [Display \(stand\)](#) or [display \(VESA mount adapter\)](#)

Power Supply Boards

Before You Begin



Ensure that the power cord is not plugged into an electrical outlet.

Remove the following part before you begin:

- [Display \(stand\)](#) or [display \(VESA mount adapter\)](#)

Tools

- Adjustable torque driver (10–34 Ncm)
- Adjustable torque driver (0.3–1.2 Nm)
- Alignment pin (3 mm)
- Alignment pin (4 mm)
- ESD-safe tweezers
- Nylon probe (black stick)
- Support wedge for tilt-adjustable stand
- Support wedge for tilt- and height-adjustable stand
- Torx T6 bit
- Torx T6 screwdriver
- Torx T8 bit
- Torx T8 screwdriver

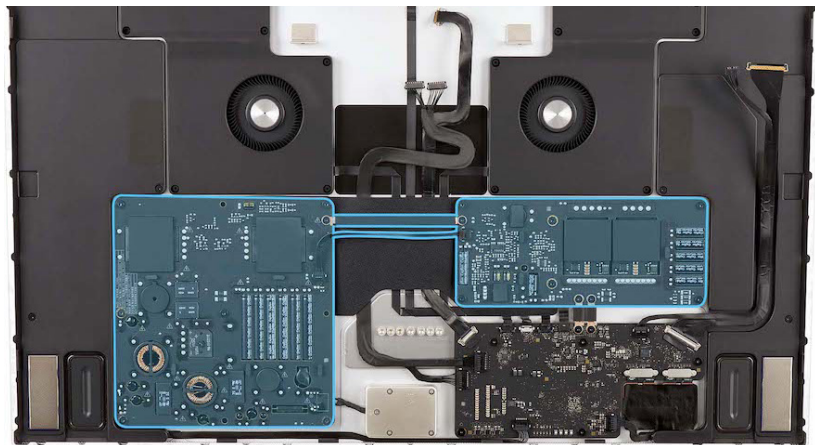

Removal

Important

Ensure that the support wedge is between the housing and the stand to keep the display in place.

1. Use the T6 screwdriver to remove the two T6 screws (923-07141) from the power supply bus bar. Remove the bus bar and save it for reassembly.

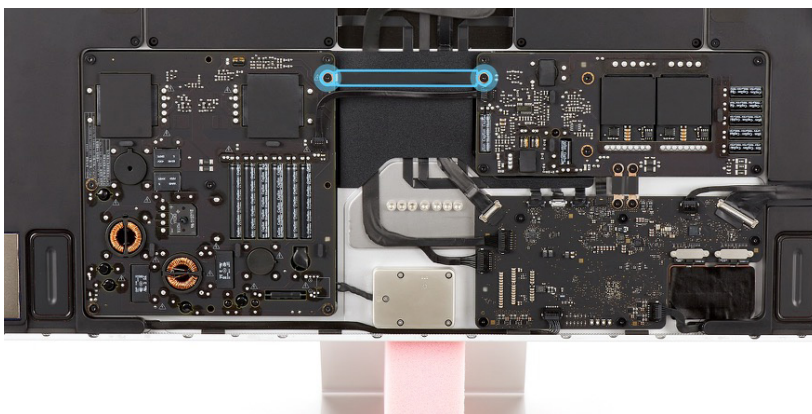

2. Use the T6 screwdriver to remove the four T6 screws (923-07141) from the logic board bus bar between the DC power supply board and the logic board. Then remove the bus bar.

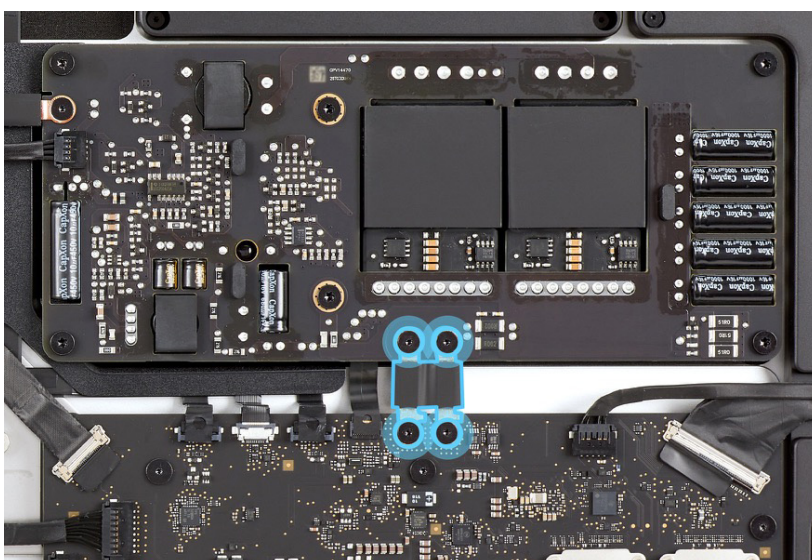

3. Pinch the sides of one end of the power supply signal cable and slide it out of the connector. Then repeat this step on the other end of the power supply signal cable.

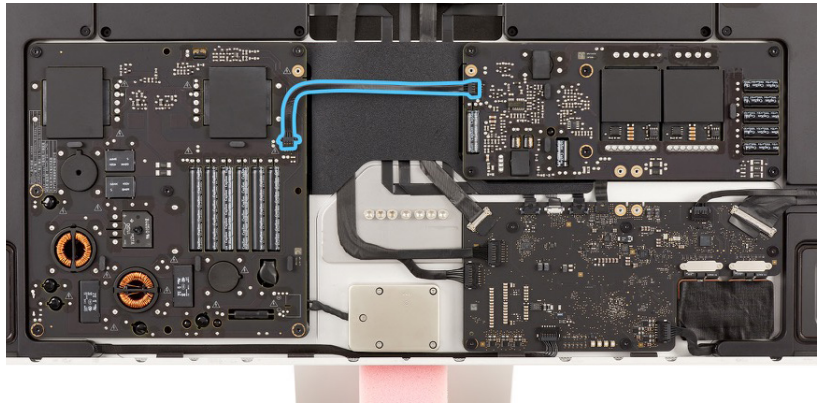

4. Use ESD-safe tweezers to peel back the polyester film tab on the power supply signal flex cable.
5. Use the black stick to flip up the locking lever on the power supply signal flex connector. Then slide the end of the flex cable out of the connector.

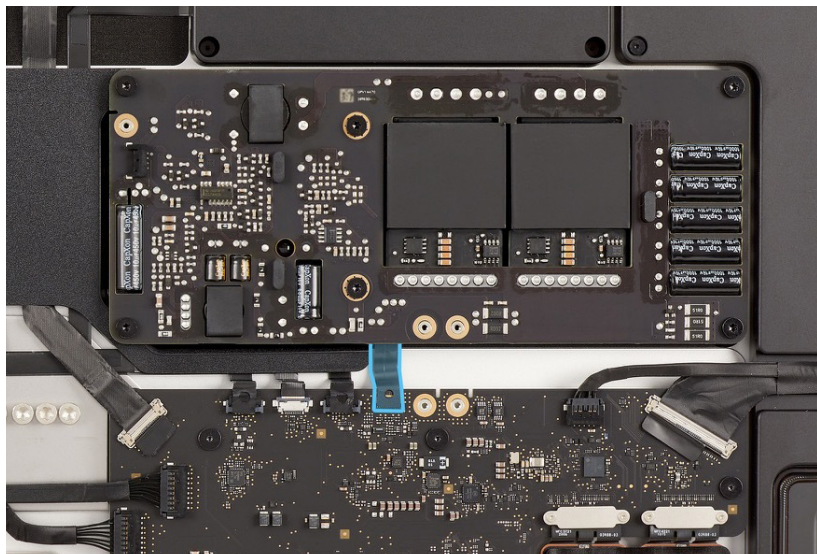

- Starting with the DC power supply board on the right, use the T8 screwdriver to remove the six T8 screws (923-07143). Then remove the DC power supply board.

Important

If you're replacing the power supply boards, continue to step 7. If you're removing the power supply boards for a different procedure, skip to step 9.

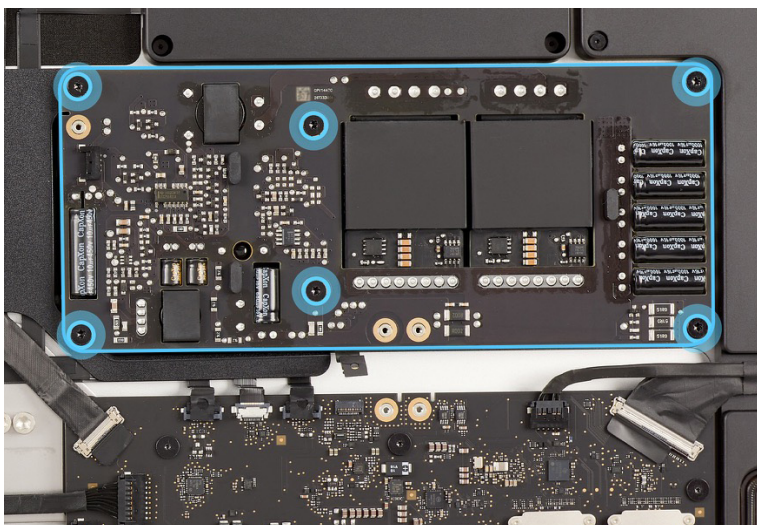

- Use ESD-safe tweezers to peel back the polyester film tab on the power supply signal flex cable.
- Use the black stick to flip up the locking lever. Then slide the end of the power supply signal flex cable out of the connector.

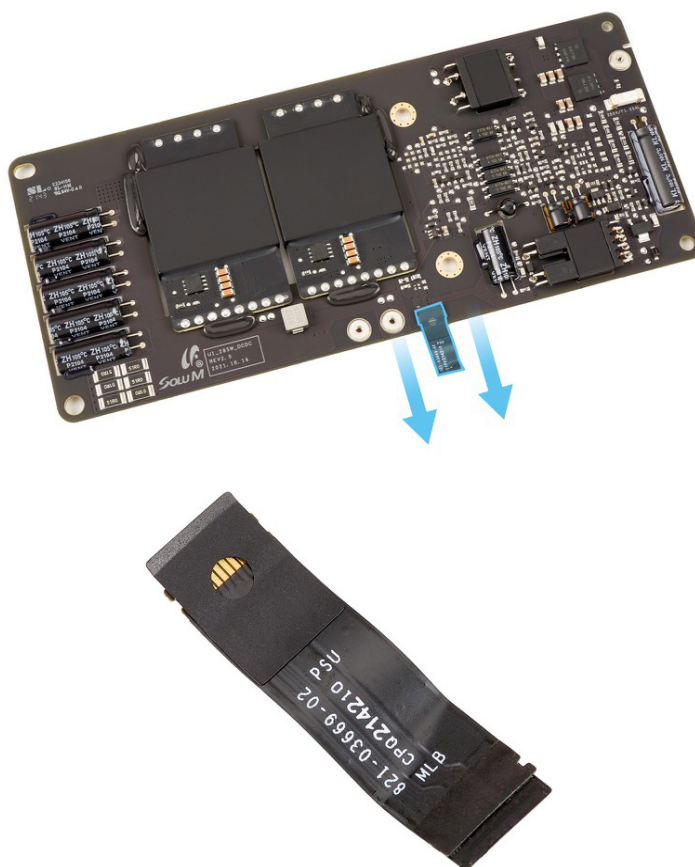

- 9 Use the T8 screwdriver to remove the six T8 screws (923-07143) from the PFC (Power Factor Controller) power supply board on the left.

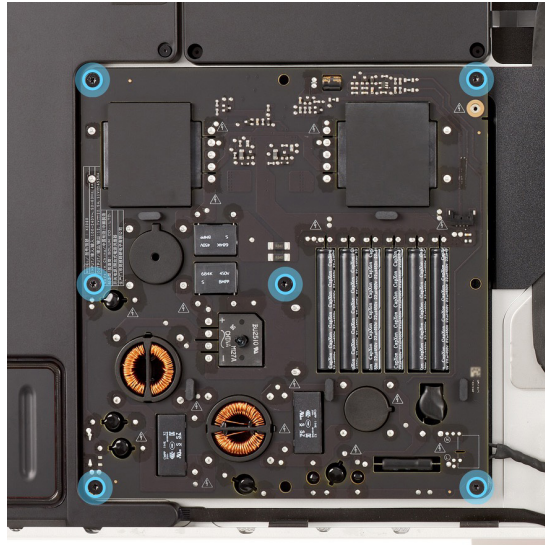

- 10 Use the black stick to lift the left side of the PFC power supply board from the housing. At the back of the board, pinch the levers at the end of the power cord port cable. Then slide the end of the cable out of the connector. Remove the PFC power supply board from the housing.

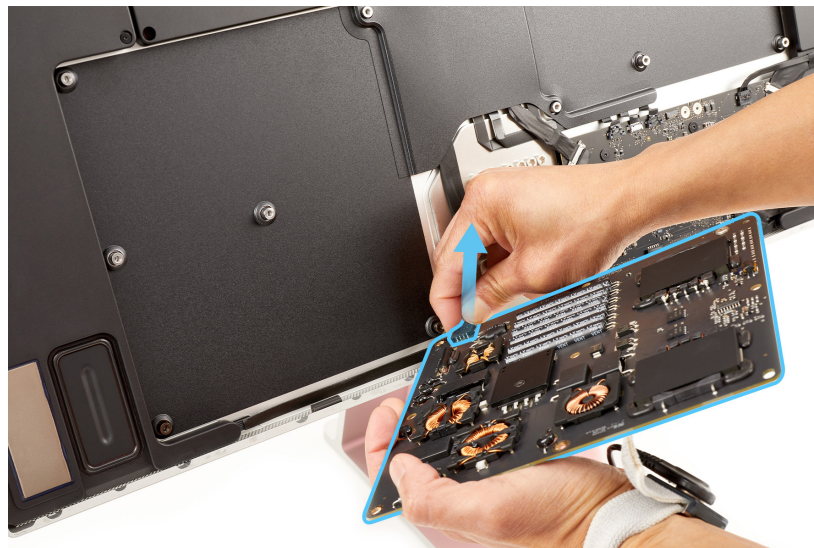

Reassembly

1. Install the 4 mm alignment pin in the upper left screw hole in the left side of the housing (1). Then install the 3 mm alignment pin in the upper right screw hole (2).

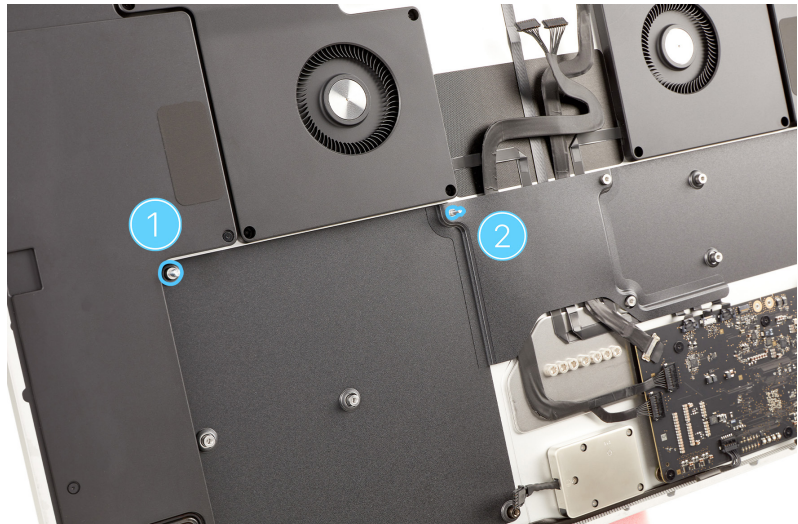

2. Slide the end of the power cord port cable into the connector on the back of the PFC power supply board.

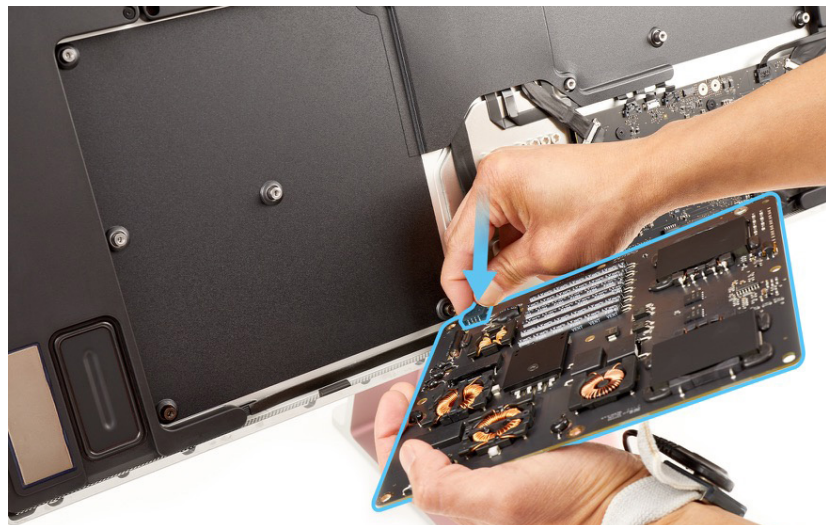

3. Position the board into the housing using the alignment pins. Use the T8 screwdriver to partially reinstall the four T8 screws (923-07143).
4. Insert the Torx T8 bit into the 0.3–1.2 Nm adjustable torque driver. Set the torque value to 0.8 Nm.
5. Use the adjustable torque driver and the Torx T8 bit to fully reinstall the four T8 screws.

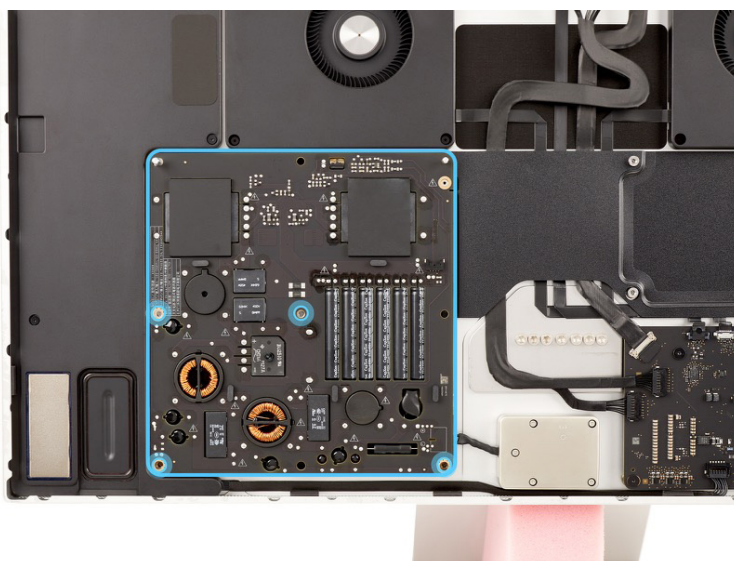

6. Remove the two alignment pins (1, 2). Then use the T8 screwdriver to partially reinstall two T8 screws (923-07143) into the PFC power supply board (1, 2).
7. Keep the Torx T8 bit in the 0.3–1.2 Nm adjustable torque driver. Ensure that the torque value is still set to 0.8 Nm.
8. Use the adjustable torque driver and the Torx T8 bit to fully reinstall the two T8 screws.

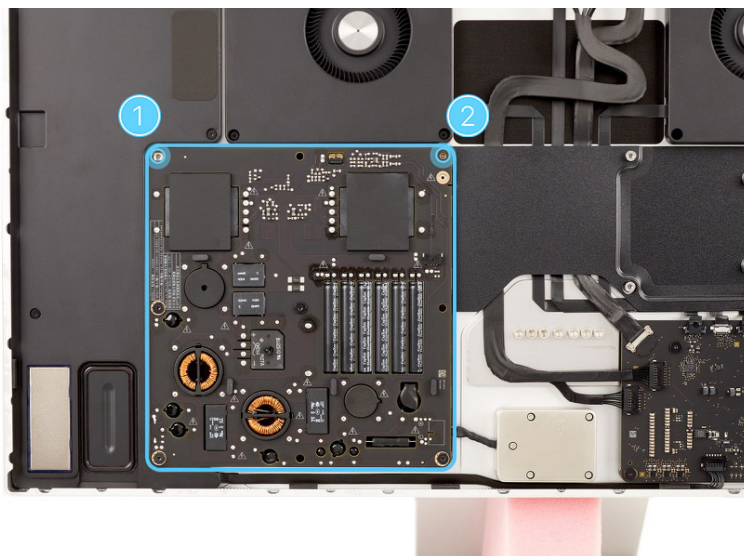

9. Install the 3 mm alignment pin in the upper left screw hole in the right side of the housing (1). Then install the 4 mm alignment pin in the upper right screw hole (2).

Important

If you're replacing the power supply boards, continue to step 10. If you removed the power supply boards as part of another procedure, skip to step 11.

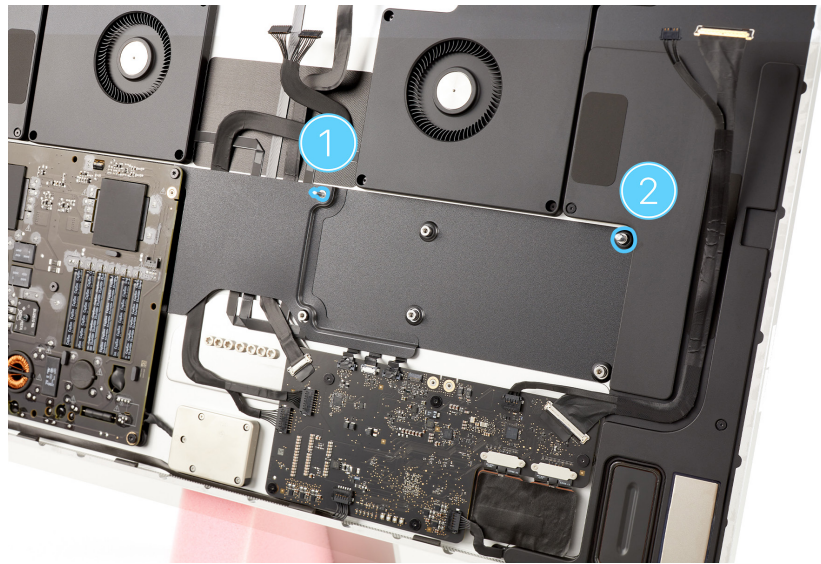

10. Turn over the DC power supply board to reinstall the original power supply signal flex cable. Slide the end of the flex cable into the connector. Use the flat end of the black stick to flip down the locking lever. Then press the polyester film tab to adhere it to the flex cable.

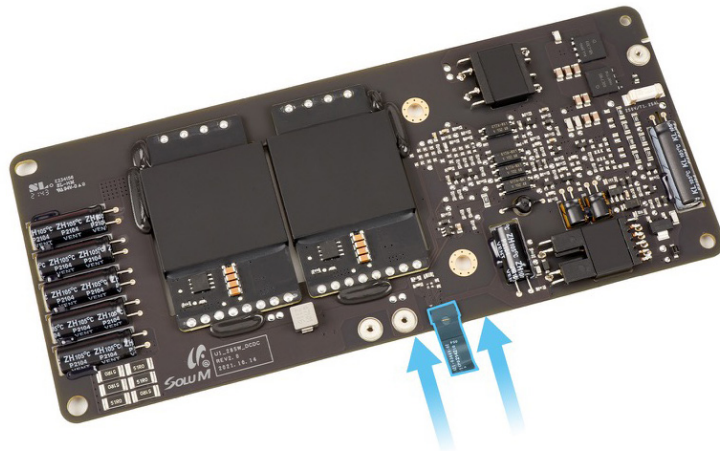

11. Position the DC power supply board in the housing. Then use the T8 screwdriver to partially reinstall four T8 screws (923-07143) as shown.
12. Keep the Torx T8 bit in the 0.3–1.2 Nm adjustable torque driver. Ensure that the torque value is still set to 0.8 Nm.
13. Use the adjustable torque driver and the Torx T8 bit to fully reinstall the four T8 screws.

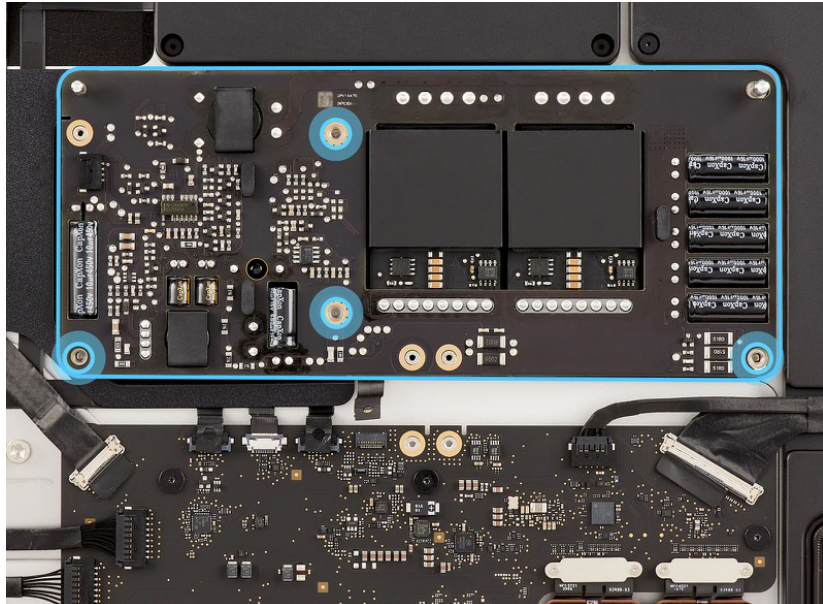

14. Remove the two alignment pins. Then use the T8 screwdriver to partially reinstall two T8 screws (923-07143) into the DC power supply board.
15. Keep the Torx T8 bit in the 0.3–1.2 Nm adjustable torque driver. Ensure that the torque value is still set to 0.8 Nm.
16. Use the adjustable torque driver and the Torx T8 bit to fully reinstall the two T8 screws.

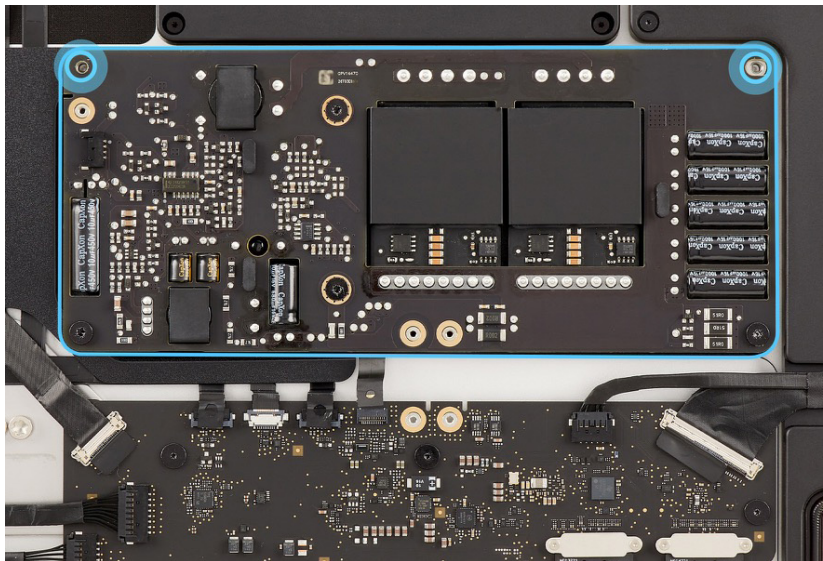

17. Position the power supply bus bar on the power supply boards. Then use the T6 screwdriver to partially reinstall the two T6 screws (923-07141) into the power supply bus bar.

Important

Ensure that the notches on the bus bar aligns with the openings in the power supply boards.

18. Insert the Torx T6 bit into the 10–34 Ncm adjustable torque driver. Set the torque value to 20.5 Ncm.
19. Use the adjustable torque driver and Torx T6 bit to fully reinstall the two T6 screws.

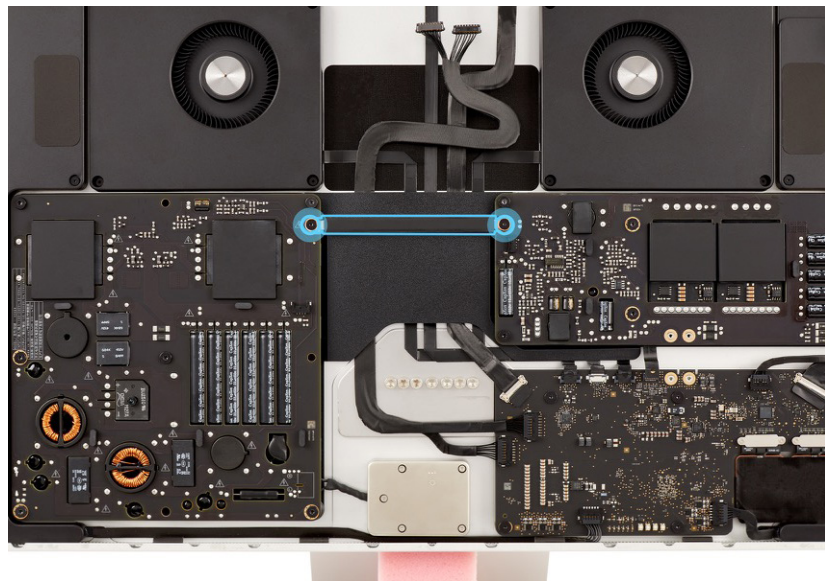

20. Position the logic board bus bar between the logic board and DC power supply board. Then use the T6 screwdriver to partially reinstall the four T6 screws (923-07141).

Important

Ensure that the hooks on the bus bar align with the notches on the logic board as shown.

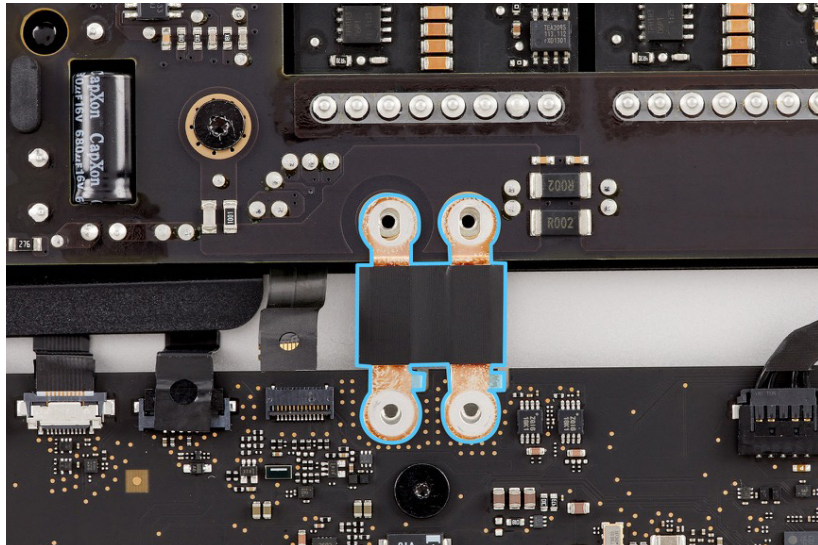

21. Keep the Torx T6 bit in the 10–34 Ncm adjustable torque driver. Ensure that the torque value is still set to 20.5 Ncm.
22. Use the adjustable torque driver and Torx T6 bit to fully reinstall the four T6 screws.

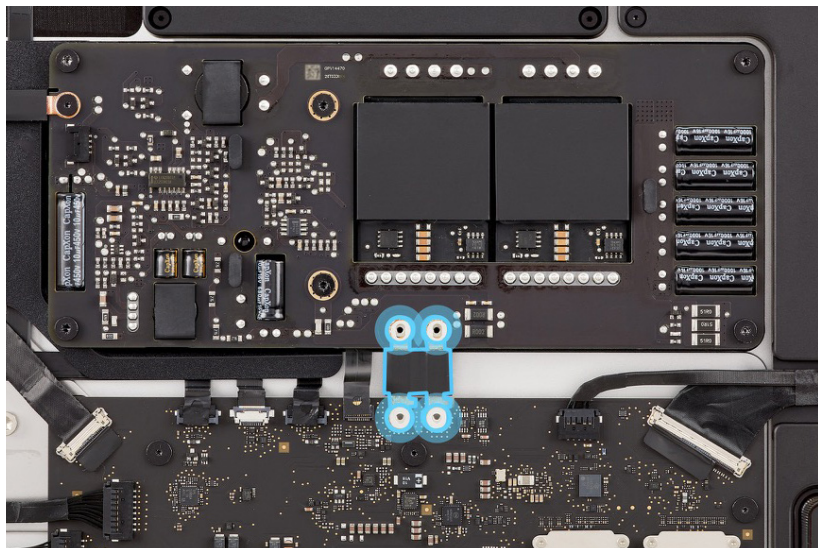

23. Slide the end of the power supply signal flex cable into the connector. Use the black stick to flip down the locking lever. Then press the polyester film tab to adhere it to the flex cable.

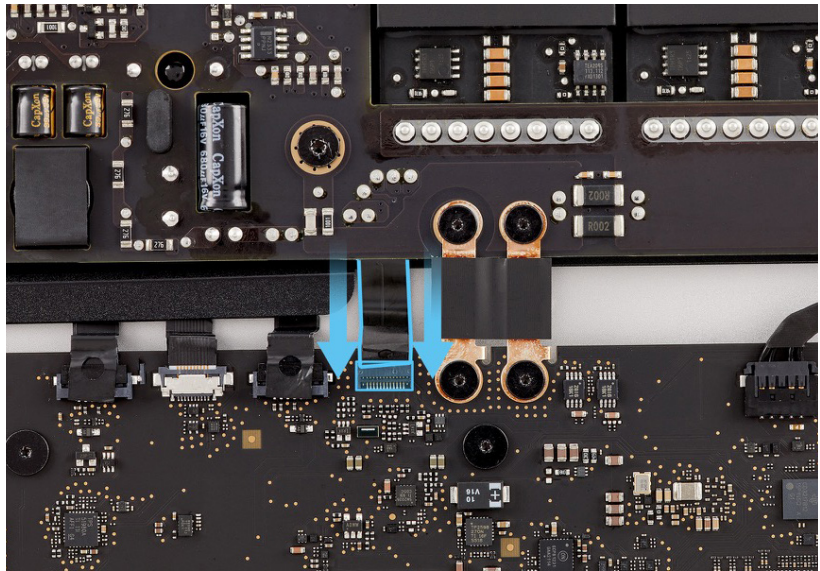

24. Slide both ends of the power supply signal cable into the connectors on the power supply boards.

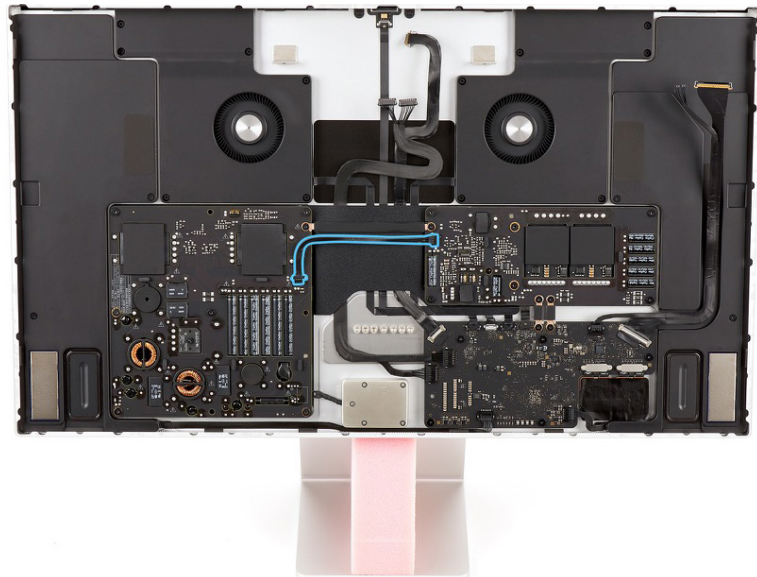

Reinstall the following part to complete reassembly:

- [Display \(stand\)](#) or [display \(VESA mount adapter\)](#)

Cables

Before You Begin



Ensure that the power cord is not plugged into an electrical outlet.

Remove the following parts before you begin:

- [Display \(stand\)](#) or [display \(VESA mount adapter\)](#)
- [Power supply boards](#)



Tools

- ESD-safe tweezers
- Nylon probe (black stick)
- Support wedge for tilt-adjustable stand
- Support wedge for tilt- and height-adjustable stand

Removal

Important

Ensure that the support wedge is between the housing and the stand to keep the housing in place.

1. Use ESD-safe tweezers to peel the polyester film tabs from both ends of the ambient light sensor flex cable. Then use the black stick to flip up the locking levers and slide the ends of the flex cable out of the connectors.
2. Use the black stick to peel the ambient light sensor flex cable off the display to remove it.

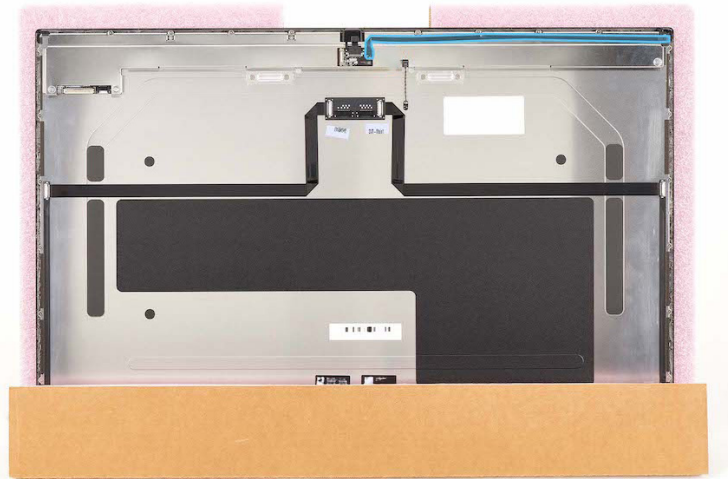

3. Pinch the sides of the end of the DisplayPort power cable and slide it out of the connector (1).
4. Pull the tab to flip up the locking bar on the DisplayPort signal flex cable (2). Then slide the end of the flex cable out of the connector (3).
5. Use the black stick to peel the DisplayPort power/signal cable bundle off the right speaker to remove it (4).

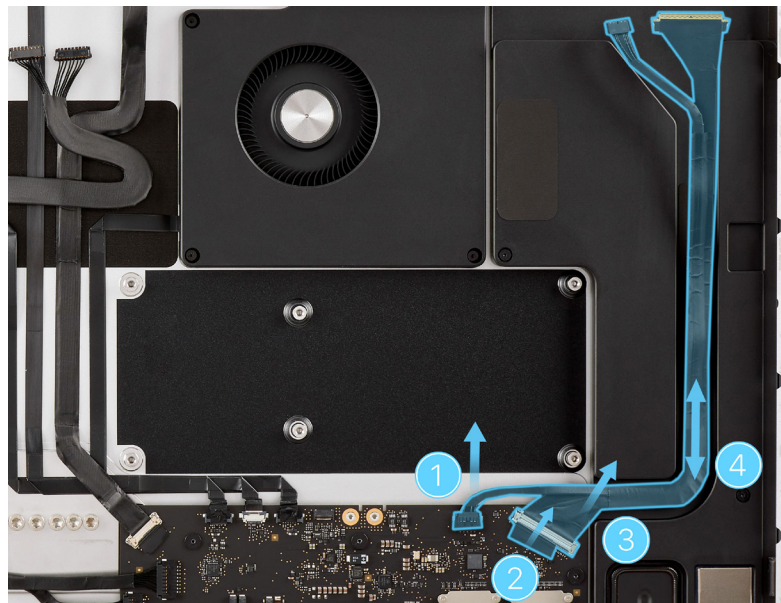

6. Use the black stick to peel the cable cover off the middle of the housing. Remove the cable cover and save it for reassembly.

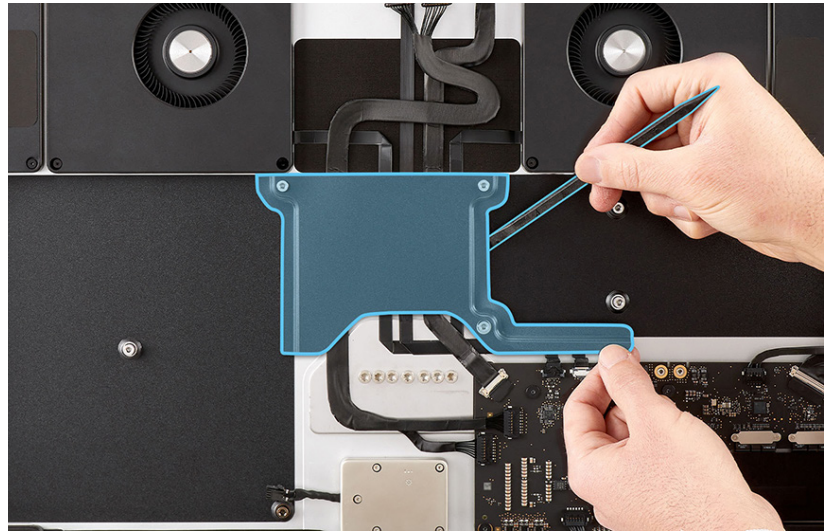

Important

Note the orientation of the cables for reassembly.

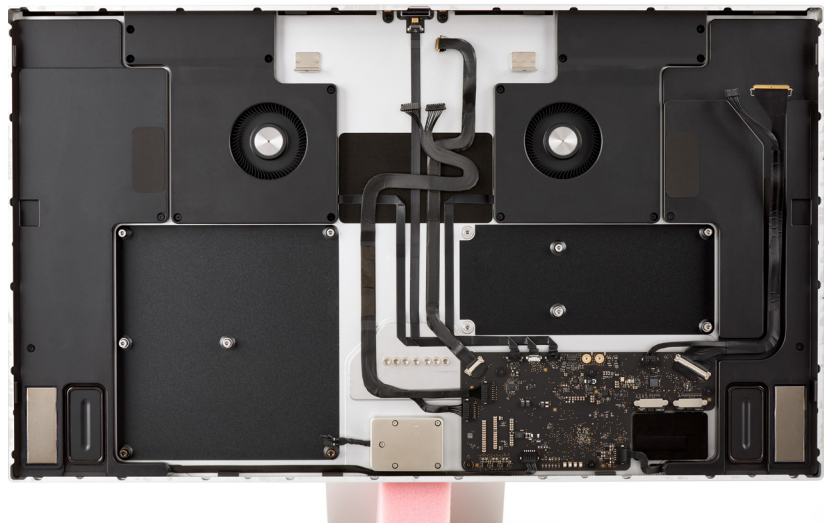

7. Pull the tab to flip up the locking bar on the camera flex cable. Then slide the end of the cable out of the connector.
8. Use the black stick to peel the camera flex cable from the housing to remove it.



9. Pinch the sides of the two ends of the display backlight cable and slide them out of the connectors.
10. Use the black stick to peel the display backlight cable from the housing to remove it.

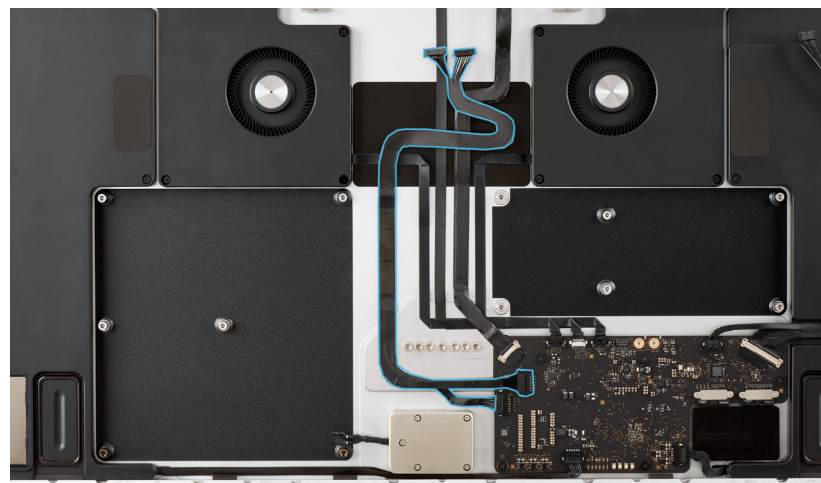

11. Follow the removal steps to remove the [right fan](#).
12. Use ESD-safe tweezers to peel back the polyester film tab. Use the flat end of the black stick to flip up the locking lever. Then slide the end of the right fan flex cable out of the connector.
13. Use the black stick to peel the display backlight cable from the housing to remove it.

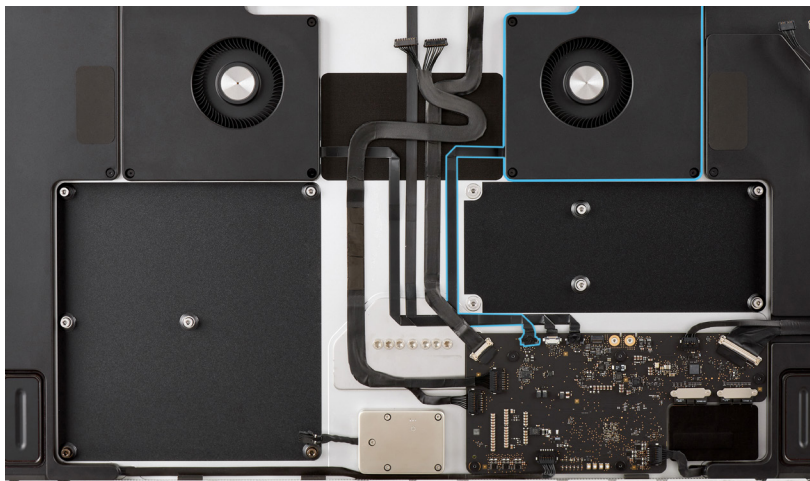

14. Use ESD-safe tweezers to peel back the polyester film tab on the logic board end of the microphone flex cable (1). Use the flat end of the black stick to press and hold the "PUSH" button on the ZIF connector on the logic board. Then use ESD-safe tweezers to slide the end of the flex cable out of the connector.

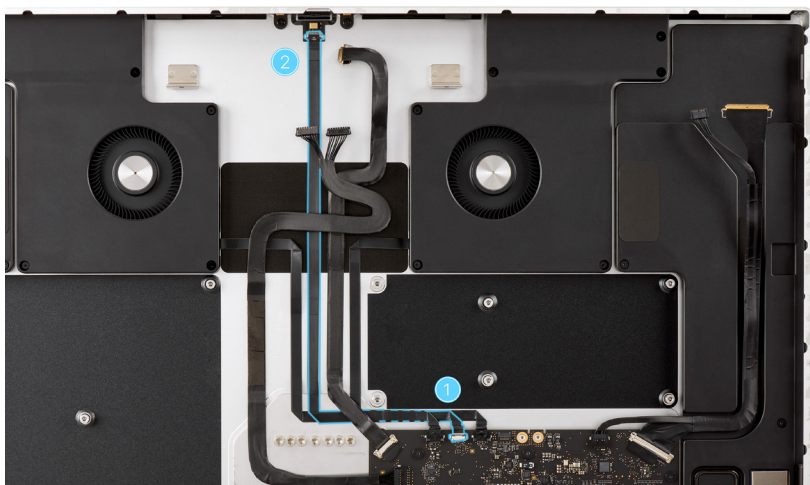

15. Use ESD-safe tweezers to peel back the polyester film tab on the microphone end of the microphone flex cable (2). Use the flat end of the black stick to press and hold the "PUSH" button on the ZIF connector on the microphone. Then use ESD-safe tweezers to slide the other end of the flex cable out of the connector.
16. Use the black stick to peel the microphone flex cable from the housing to remove it.

17. Follow the removal steps to remove the [left fan](#).
18. Use ESD-safe tweezers to peel back the polyester film tab on the end of the left fan flex cable. Use the flat end of the black stick to flip up the locking lever. Then slide the end of the left fan flex cable out of the connector.
19. Use the black stick to peel the left fan flex cable from the housing to remove it.



Reassembly

1. Position the left fan flex cable in the housing as shown.
2. Slide the end of the left fan flex cable into the connector on the logic board. Use the black stick to flip down the locking lever. Then press the polyester film tab to adhere it to the end of the flex cable.
3. Run the flat end of the black stick along the length of the left fan flex cable to adhere it to the housing.
4. Follow the reassembly steps to reinstall the [left fan](#).

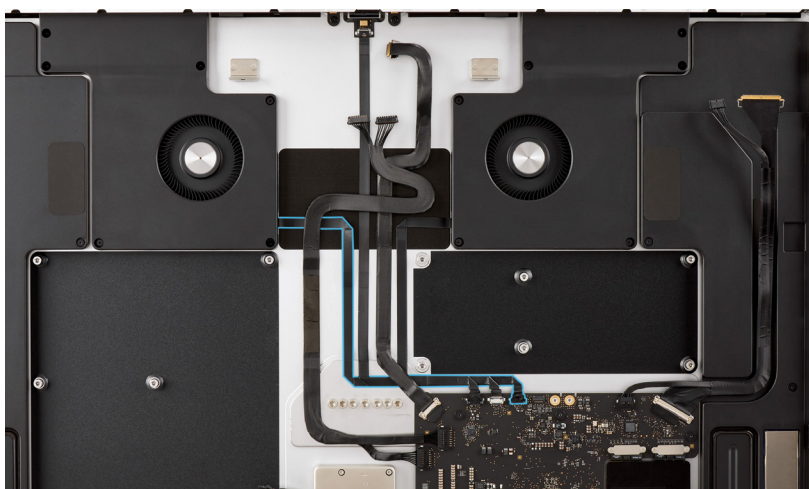

5. Position the microphone flex cable in the housing as shown.
6. Slide one end of the microphone flex cable into the connector on the microphone. Ensure that the flex cable is fully inserted. Then press the polyester film tab to adhere it to the end of the flex cable.
7. Slide the other end of the microphone flex cable into the connector on the logic board. Ensure that the cable is fully inserted. Then press the polyester film tab to adhere it to the end of the flex cable.

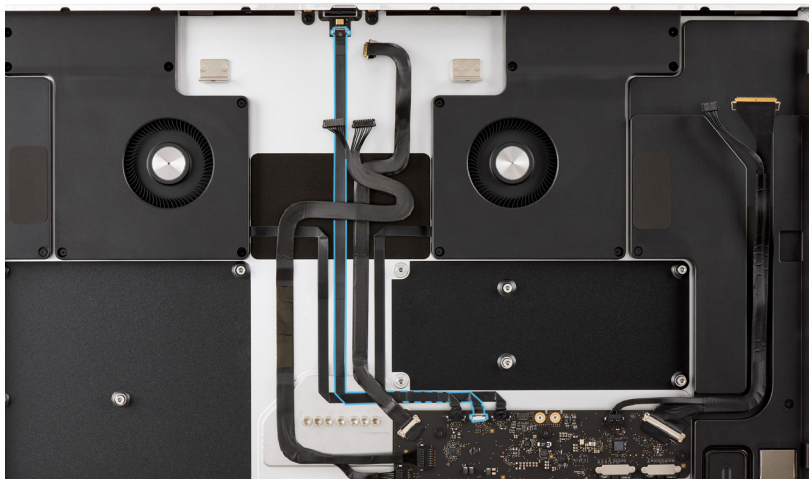

8. Run the flat end of the black stick along the length of the flex cable to adhere it to the housing.

9. Position the right fan flex cable in the housing.
10. Slide the end of the right fan flex cable into the connector on the logic board. Use the black stick to flip down the locking lever. Then press the polyester film tab to adhere it to the end of the flex cable.
11. Run the flat end of the black stick along the length of the right fan flex cable to adhere it to the housing.
12. Follow the reassembly steps to reinstall the [right fan](#).

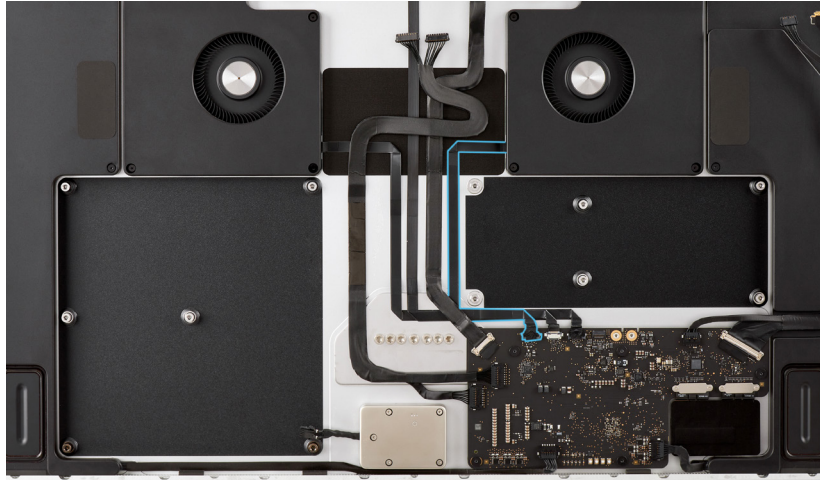

13. Position the display backlight cable in the housing.
14. Slide the two ends of the display backlight cable into the connectors on the logic board.
15. Run the flat end of the black stick along the length of the display backlight cable to adhere it to the housing.

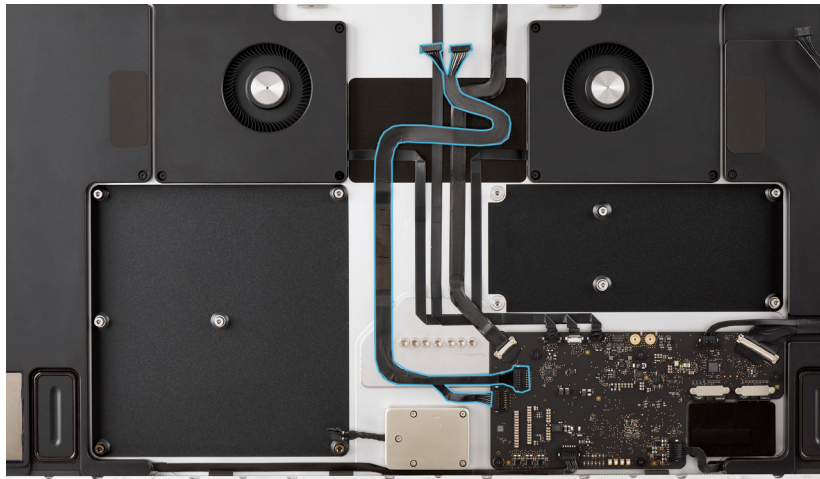

16. Position the camera flex cable in the housing.
17. Slide one end of the camera flex cable into the connector on the logic board. Then use the black stick to flip down the locking bar.
18. Run the flat end of the black stick along the length of the camera flex cable to adhere it to the housing.

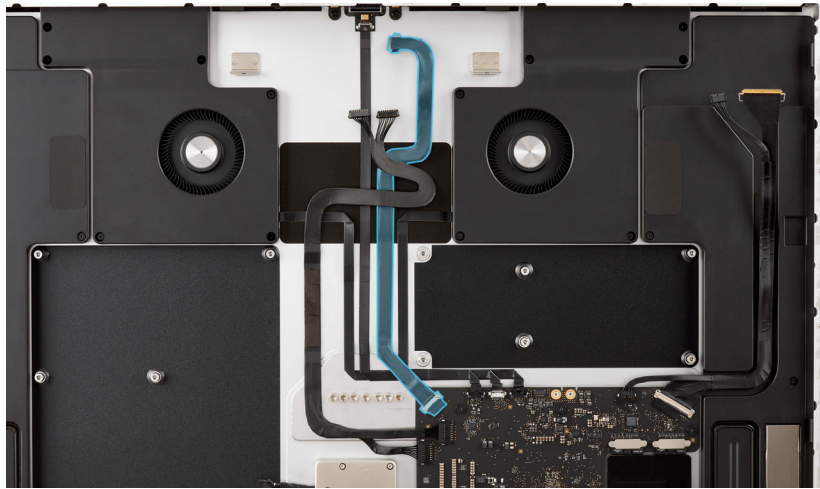

19. Use the black stick to position the cable cover over the cables in the middle of the housing. Then press along the edges of the cable cover to adhere it to the housing.

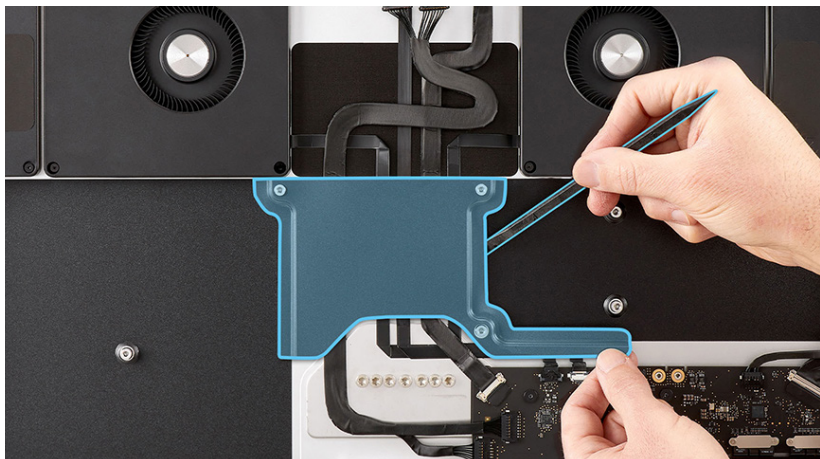

20. Position the DisplayPort power/signal cable bundle in the channel in the right speaker.
21. Slide the end of the DisplayPort power cable into the connector on the logic board (1).
22. Slide the end of the DisplayPort signal flex cable into the connector on the logic board (2). Then use the black stick to flip down the locking bar (3).
23. Run the flat end of the black stick along the length of the cable to adhere it in the channel on the right speaker (4).



24. Position the ambient light sensor flex cable in the channel in the right speaker.
25. Slide each end of the ambient light sensor flex cable into the connectors on the display. Then use the black stick to flip down the locking levers. Press the polyester film tabs to adhere them to the ends of the flex cable.
26. Run the flat end of the black stick along the length of the ambient light sensor flex cable to adhere it to the display.

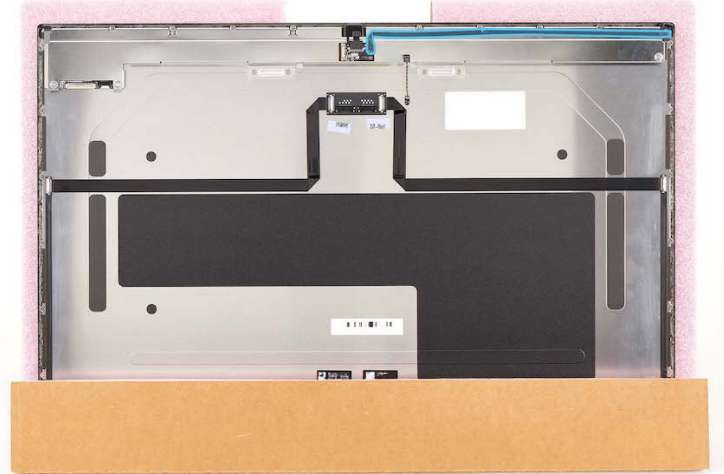

Reinstall the following parts to complete reassembly:

- [Power supply boards](#)
- [Display \(stand\)](#) or [display \(VESA mount adapter\)](#)

Power Cord Port

Before You Begin



Danger

Ensure that the power cord is not plugged into an electrical outlet.

Remove the following parts before you begin:

- [Display \(stand\)](#) or [display \(VESA mount adapter\)](#)
- [Power cord](#)

Tools

- Adjustable torque driver (10–34 Ncm)
- Adjustable torque driver (0.3–1.2 Nm)
- Alignment pin (3 mm)
- Alignment pin (4 mm)
- Nylon probe (black stick)
- Support wedge for tilt-adjustable stand
- Support wedge for tilt- and height-adjustable stan
- Torx T5 bit
- Torx T5 screwdriver
- Torx T6 bit
- Torx T6 screwdriver
- Torx T8 bit
- Torx T8 screwdriver

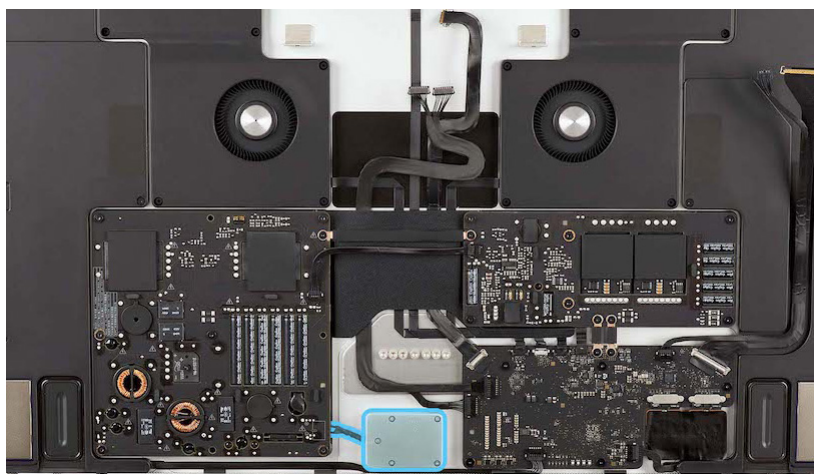

Removal

Important

Ensure that the support wedge is between the housing and the stand to keep the display in place.

1. Use the T6 screwdriver to remove the two T6 screws (923-07141) from the power supply bus bar. Remove the bus bar and save it for reassembly.

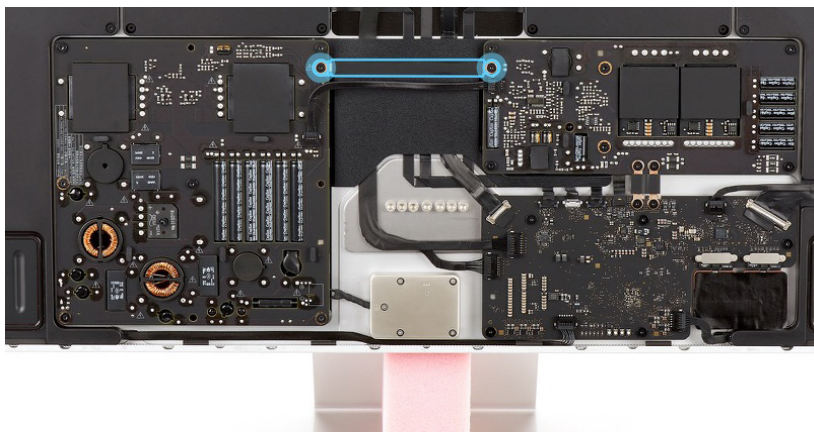

2. Pinch the sides of the end of the power supply signal cable and slide it out of the connector on the power factor controller (PFC) power supply board.

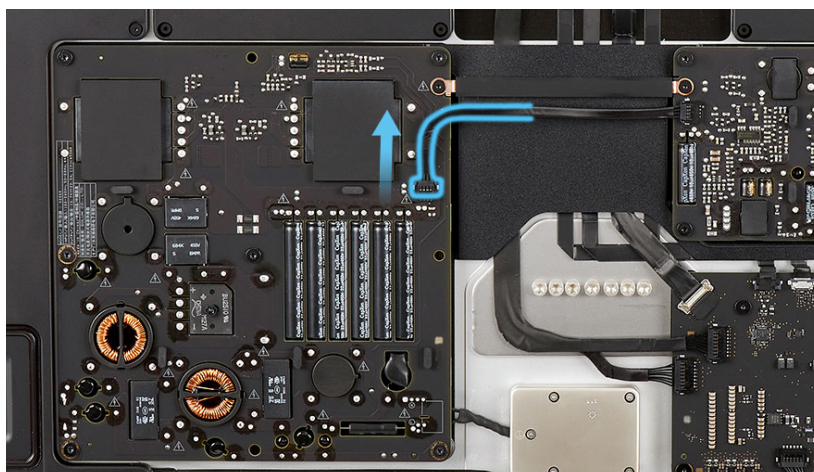

3. Use the T8 screwdriver to remove the six T8 screws (923-07143) from the PFC power supply board on the left.

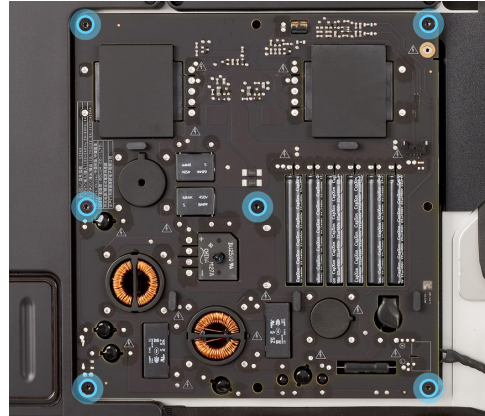

4. Use the black stick to lift the left side of the PFC power supply board from the housing.

5. At the back of the board, pinch the levers at the end of the power cord port cable. Then slide the cable out of the connector.

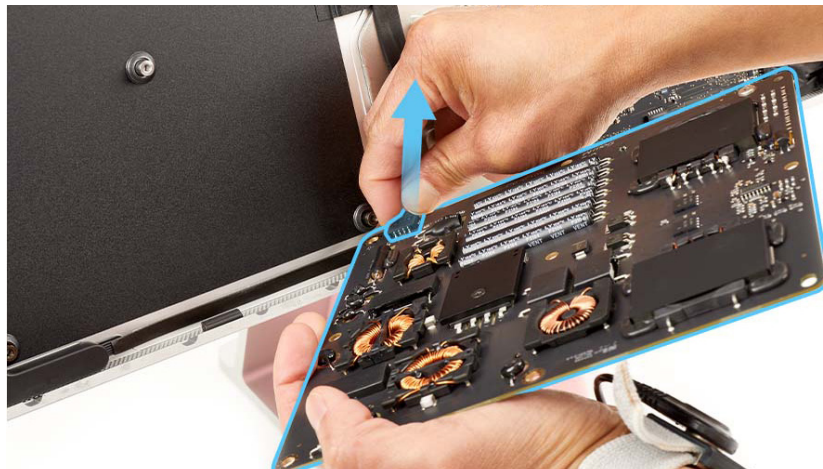

6. Remove the PFC power supply board from the housing and set it aside.

7. Use the T5 screwdriver to remove four T5 screws (923-07146) (1-4) from the power cord port.
8. Use the T5 screwdriver to remove the T5 grounding screw (923-07145) (5) from the power cord port.
9. Remove the power cord port from the housing.

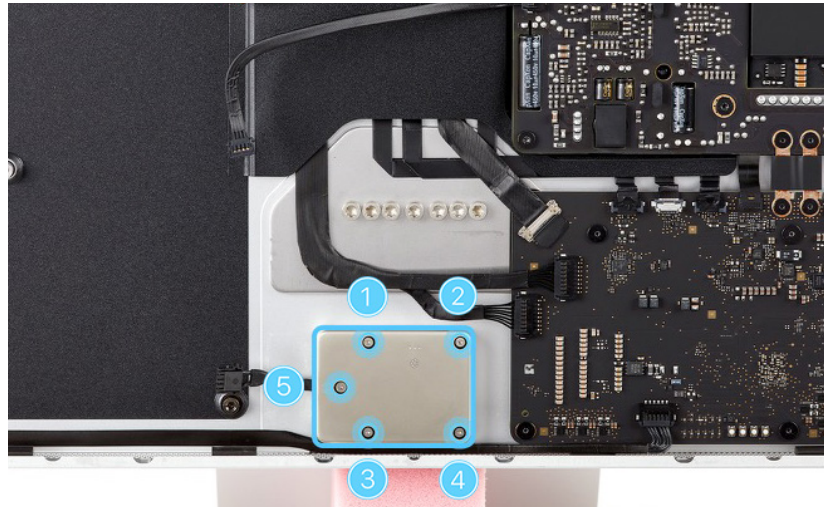

Reassembly

1. Position the power cord port in the housing. Use the T5 screwdriver to partially reinstall four T5 screws (923-07146) into the power cord port in the order shown.
2. Insert the Torx T5 bit into the 10–34 Ncm adjustable torque driver. Set the torque value to 14.5 Ncm. Use the adjustable torque driver and Torx T5 bit to fully reinstall the four T5 screws in the order shown.

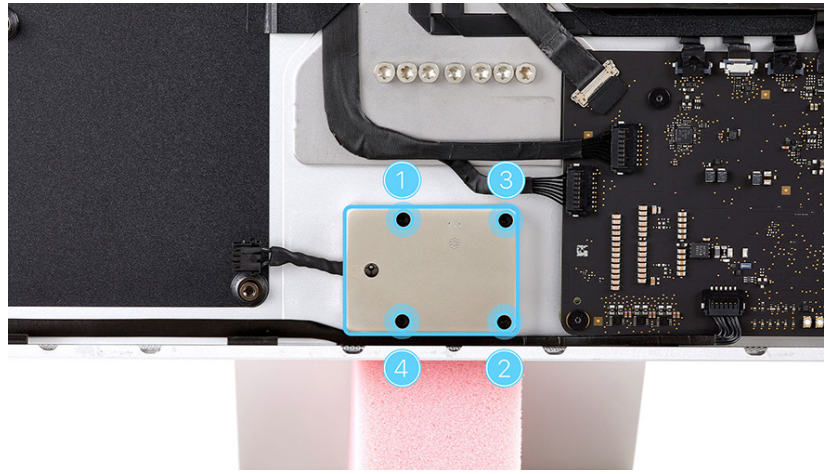

3. Use the T5 screwdriver to partially reinstall one T5 grounding screw (923-07145) into the power cord port as shown. Keep the Torx T5 bit in the 10–34 Ncm adjustable torque driver. Set the torque value to 25 Ncm. Use the adjustable torque driver and Torx T5 bit to fully reinstall the T5 screw.

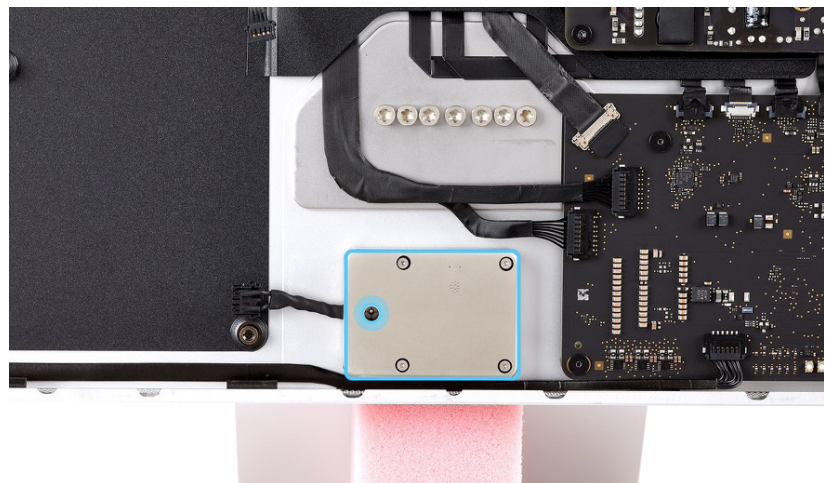

4. Install the 4 mm alignment pin in the upper left screw hole in the left side of the housing (1). Then install the 3 mm alignment pin in the upper right screw hole (2).

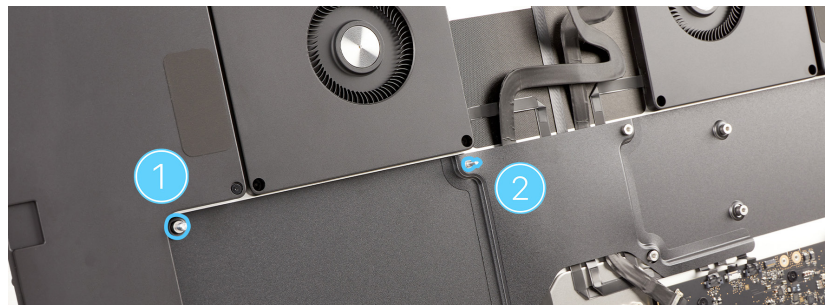

- Slide the power cord port cable into the connector on the back of the PFC power supply board.

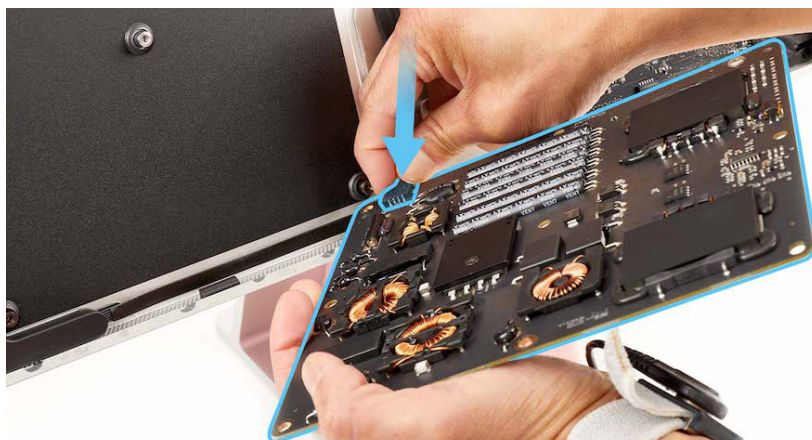

- Align the upper left and upper right screw holes of the PFC power supply board over the two alignment pins.

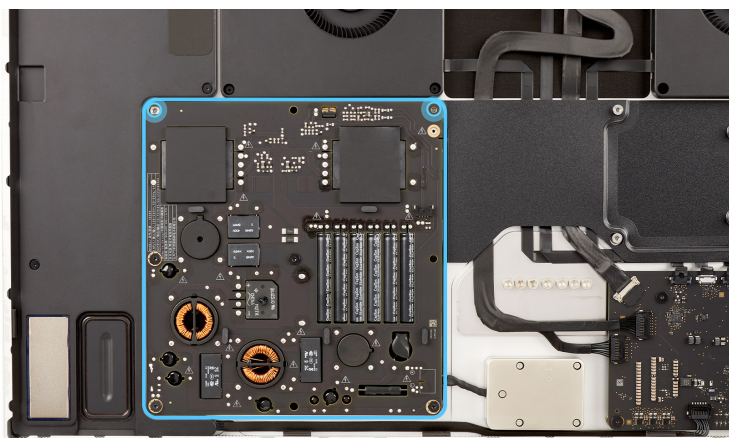

- Use the T8 screwdriver to partially reinstall four T8 screws (923-07143) as shown.
- Insert the Torx T8 bit into the 0.3–1.2 Nm adjustable torque driver. Set the torque value to 0.8 Nm. Use the adjustable torque driver and Torx T8 bit to fully reinstall the four T8 screws.

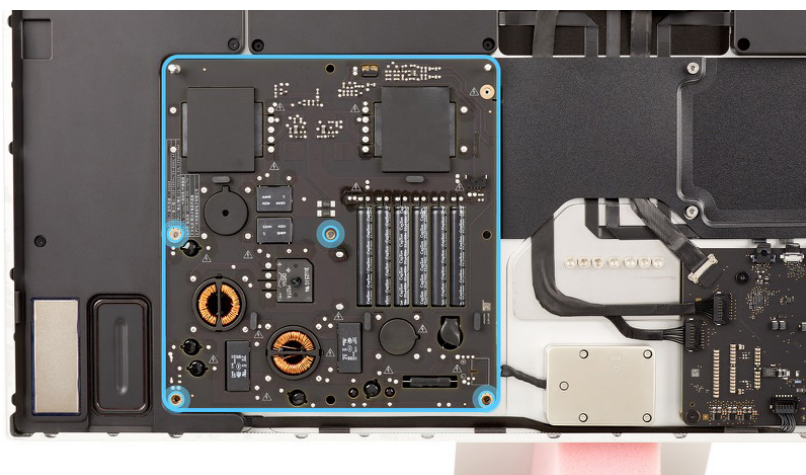

9. Remove the two alignment pins (1, 2). Then use the T8 screwdriver to partially reinstall two T8 screws (923-07143) into the PFC power supply board (1, 2).
10. Keep the Torx T8 bit in the 0.3–1.2 Nm adjustable torque driver. Ensure that the torque value is still set to 0.8 Nm.
11. Use the adjustable torque driver and Torx T8 bit to fully reinstall the two T8 screws.
12. Slide the end of the power supply signal cable into the connector on the PFC power supply board.

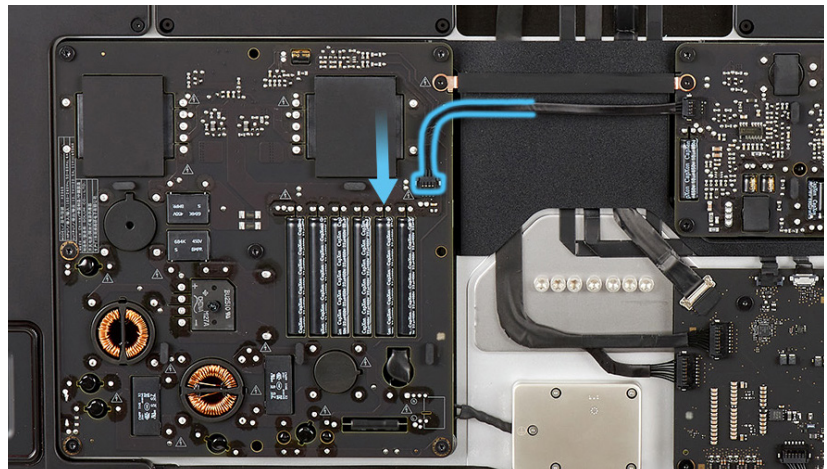
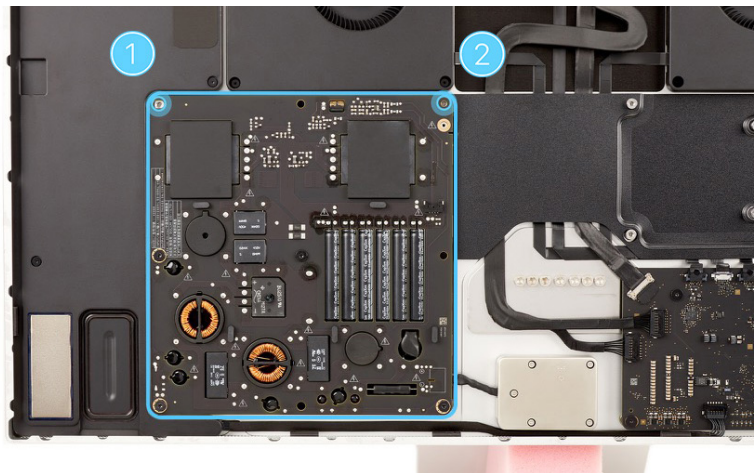

13. Position the power supply bus bar on the power supply boards. Then use the T6 screwdriver to partially reinstall the two T6 screws (923-07141) into the bus bar.

Important

Ensure that the notches on the bus bar align with the openings in the power supply boards.



14. Insert the Torx T6 bit into the 10–34 Ncm adjustable torque driver. Set the torque value to 20.5 Ncm.
15. Use the adjustable torque driver and Torx T6 bit to fully reinstall the two T6 screws.

Reinstall the following parts to complete reassembly:

- [Power cord](#)
- [Display \(stand\)](#) or [display \(VESA mount adapter\)](#)

Power Cord

Before You Begin



Ensure that the power cord is not plugged into an electrical outlet.

Tools

- Power cord removal tool

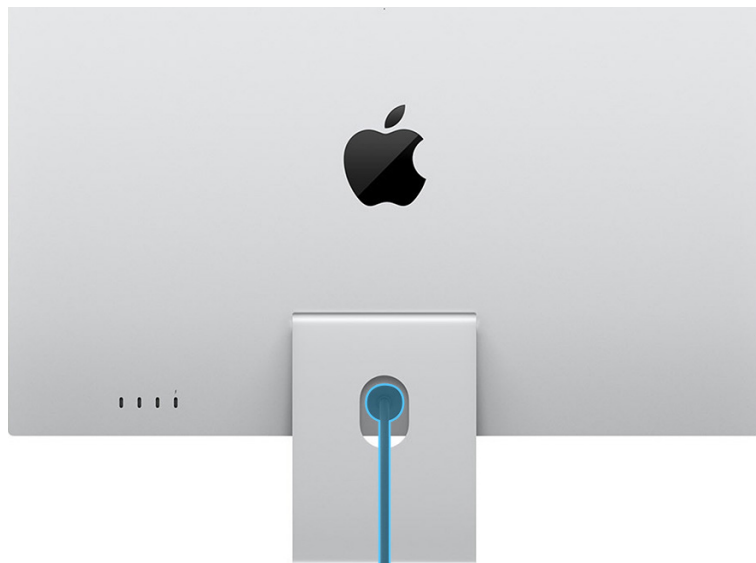

Removal

Important

If a support wedge is inserted between the housing and the stand, remove it.

1. Press the power cord removal tool against the back of the stand. Create just enough clearance between the tool and stand. Then wrap the power cord around the tool twice.

Important

Ensure that the display is tilted completely downward.



2. Hold the cord and the power cord removal tool with the same hand. Ensure that the cord is aligned with the port. Use your other hand to hold the stand for stability.

Caution

Ensure that the power cord has a direct line for removal to avoid damaging the pins.

Important

For the VESA mount adapter, lay the housing flat on the table. Hold down the housing for stability.

3. Rotate the power cord removal tool downward to unplug the power cord.



Reassembly

1. Align the notch on the port with the opening on the end of the cord. Then insert the power cord into the port.

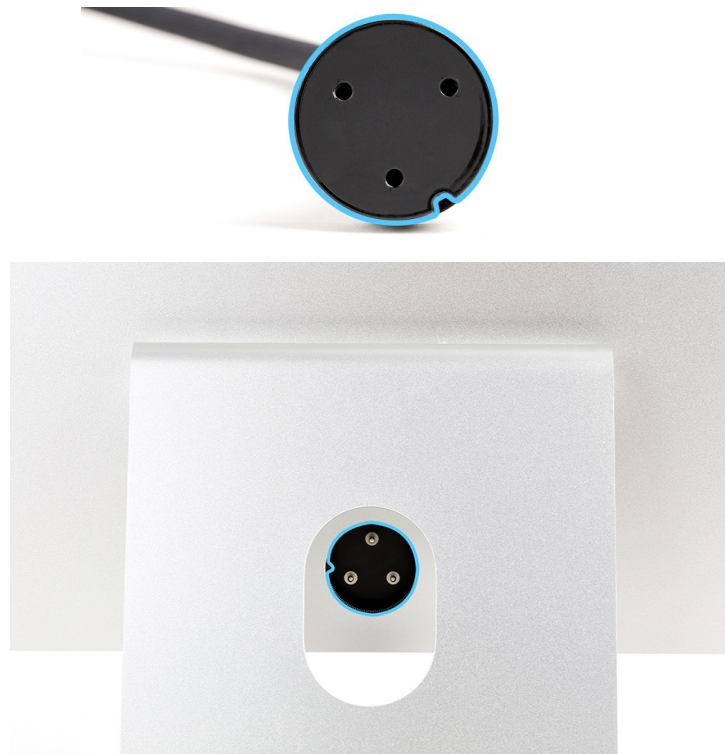

2. Check that the power cord is flush with the back of the display.



Tilt-Adjustable Stand

Before You Begin

Danger

Ensure that the power cord is not plugged into an electrical outlet.

Caution

Some images show the power cord removed from the display, but during this procedure the power cord should remain connected to the display.

Remove the following part before you begin:

- [Display \(stand\)](#)

Tools

- Adjustable torque wrench (2.5–25 Nm)
- Alignment pins for stand and VESA mount adapter
- Flathead screwdriver
- Support wedge for tilt-adjustable stand
- Torx Plus 20IP 70 mm bit

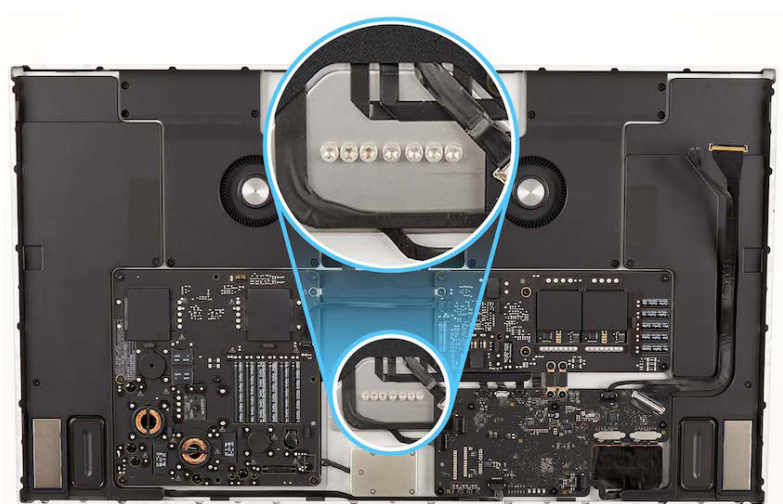

Removal

Important

Ensure that the support wedge is between the enclosure and the stand to keep the display in place.

1. Insert the 20IP bit into the 2.5–25 Nm adjustable torque wrench. Use the adjustable torque wrench and 20IP bit to remove the two 20IP screws (452-06708) as shown.



2. Replace the removed screws with the alignment pins for stand and VESA mount adapter.

Note: If the alignment pins don't easily screw in, loosen the other five 20IP screws.



3. Use the adjustable torque wrench and 20IP bit to remove the middle 20IP screw (452-06710) and the four outer 20IP screws (452-06708) in the order shown.



4. Lift the housing from the stand.

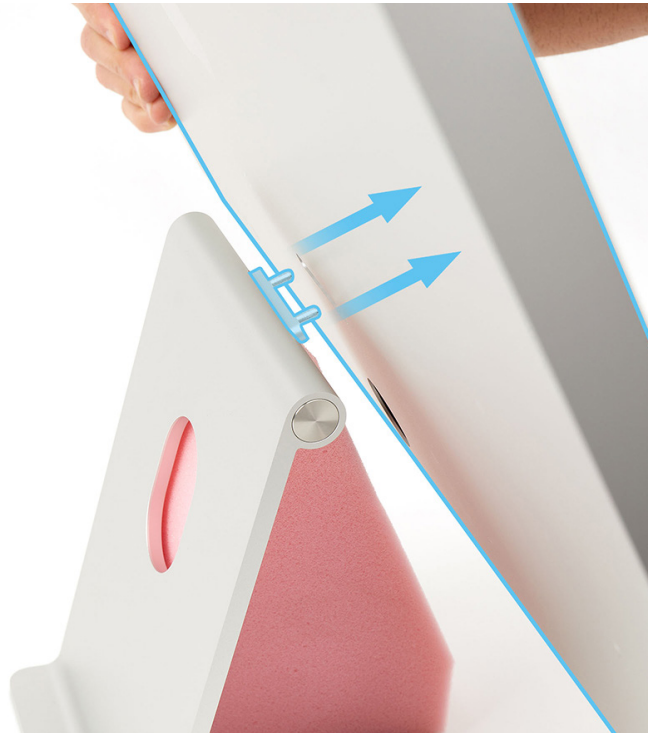

5. Remove the alignment pins from the stand.



6. Remove the flange from the stand.

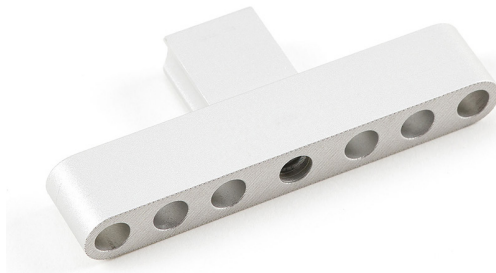

Reassembly

Important

- If you're installing a replacement tilt-adjustable stand, use the screws included with the replacement stand.
- To replace the removed stand with a tilt- and height-adjustable stand, follow the reassembly steps in [Tilt- and Height-Adjustable Stand](#).
- To replace the removed stand with a VESA mount adapter, follow the reassembly steps in [VESA Mount Adapter](#).

1. Insert the flange into the stand.

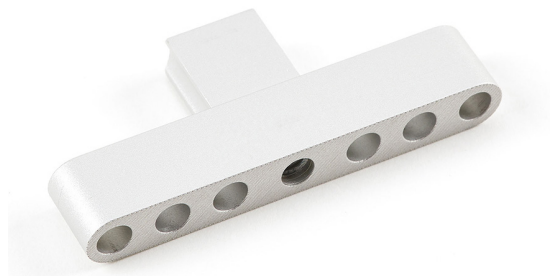

2. Install the two alignment pins into the flange as shown.



3. Use the alignment pins to position the display onto the stand.



4. Insert the 20IP bit into the 2.5–25 Nm adjustable torque wrench. Use the adjustable torque wrench and 20IP bit to partially reinstall the middle 20IP screw (452-06710) and the four outer 20IP screws (452-06708) in the order shown.



5. Keep the 20IP bit in the 2.5–25 Nm adjustable torque wrench. Set the torque value to 3.5 Nm.

6. Use the adjustable torque wrench and 20IP bit to fully reinstall the middle 20IP screw to 3.5 Nm.



7. Use the adjustable torque wrench and 20IP bit to partially reinstall the remaining four 20IP screws to 3.5 Nm in the order shown.

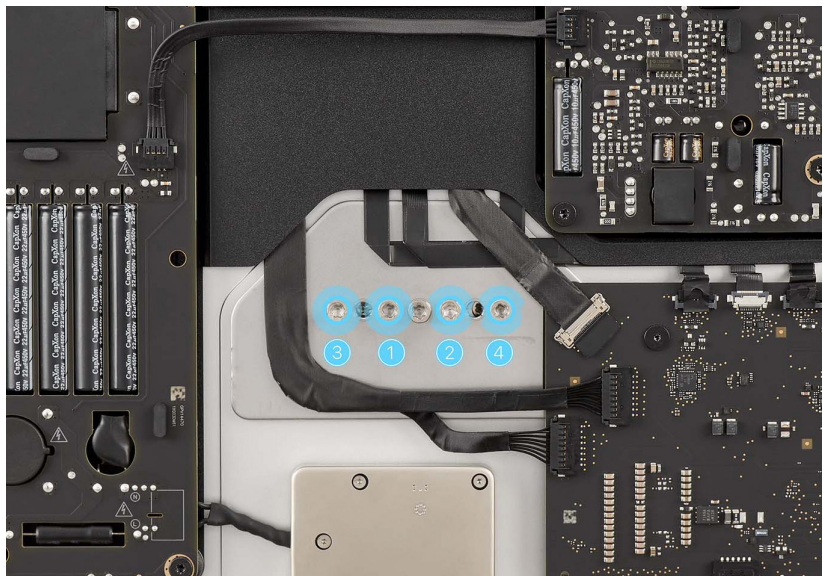

8. Remove the two alignment pins. Then use the adjustable torque wrench and 20IP bit to partially reinstall two 20IP screws (452-06708) as shown.

Note: The alignment pins may get stuck. If they do, use a flathead screwdriver to remove the alignment pins.

9. Ensure that the torque value is still set to 3.5 Nm. Use the adjustable torque wrench and 20IP bit to partially reinstall the two 20IP screws to 3.5 Nm as shown.



10. Keep the 20IP bit in the 2.5–25 Nm adjustable torque wrench. Set the torque value to 6.4 Nm. Use the adjustable torque wrench and 20IP bit to fully reinstall the six 20IP screws in the order shown.

 **Caution**

Don't tighten the middle screw. It was set to the correct torque in a previous step.

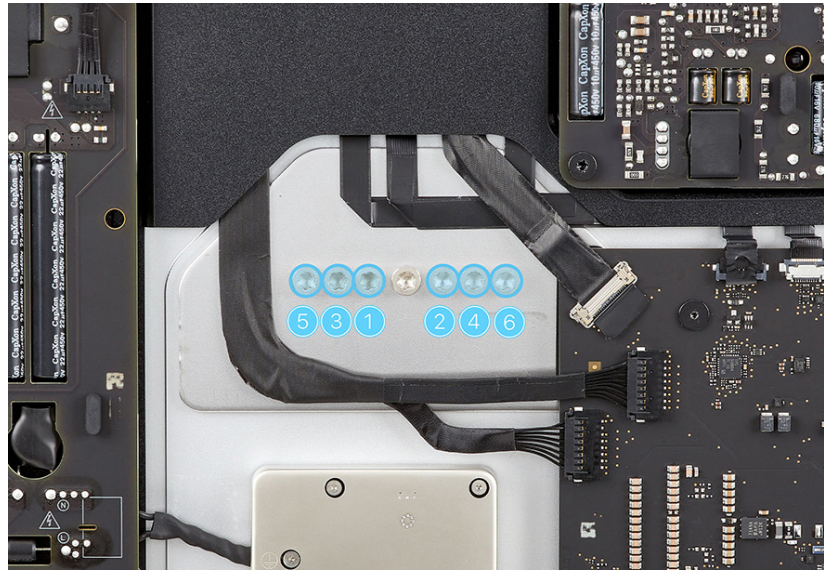

Reinstall the following part to complete reassembly:

- [Display \(stand\)](#)

Tilt- and Height-Adjustable Stand

Before You Begin

Danger

Ensure that the power cord is not plugged into an electrical outlet.

Caution

Some images show the power cord removed from the display, but during this procedure the power cord should remain connected to the display.

Remove the following part before you begin:

- [Display \(stand\)](#)

Tools

- Adjustable torque wrench (2.5–25 Nm)
- Alignment pins for stand and VESA mount adapter
- Flathead screwdriver
- Support wedge for tilt- and height-adjustable stand
- Torx Plus 20IP 70 mm bit

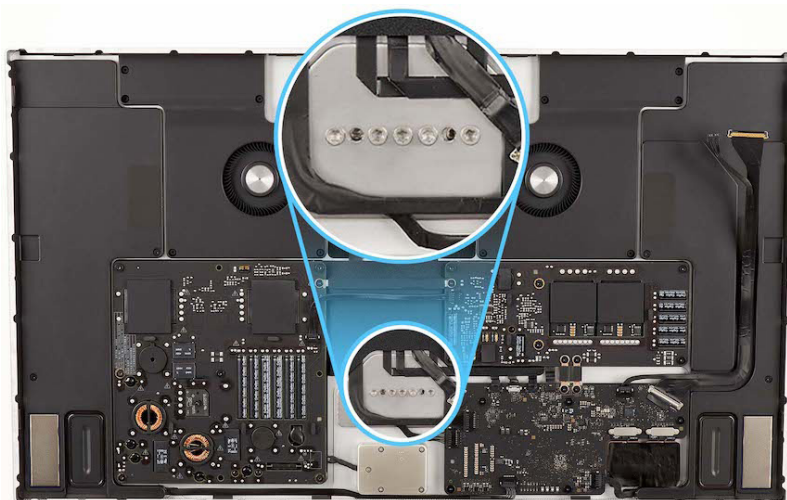

Removal

Important

Ensure that the support wedge is between the enclosure and the stand to keep the display in place.

1. Insert the 20IP bit into the 2.5–25 Nm adjustable torque wrench. Remove the two 20IP screws (452-07329) in the order shown. Then install the two alignment pins for stand and VESA mount adapter in the same order.

Note: If the alignment pins do not easily fit in, loosen the other three 20IP screws.



2. Use the adjustable torque wrench and 20IP bit to remove the remaining three 20IP screws in the order shown:

- (452-07330) (1)
- (452-07329) (2, 3)

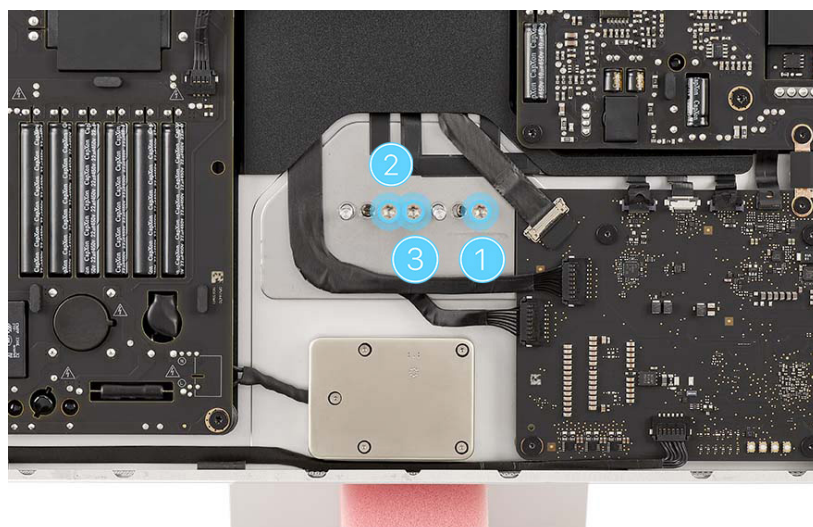

3. Lift the housing from the stand.



4. Remove the alignment pins from the stand.



Reassembly

Important

- If you're installing a replacement tilt- and height-adjustable stand, use the screws included with the replacement stand.
- To replace the removed stand with a tilt-adjustable stand, follow the reassembly steps in [Tilt-Adjustable Stand](#).
- To replace the removed stand with a VESA mount adapter, follow the reassembly steps in [VESA Mount Adapter](#).

1. Install the two alignment pins for stand and VESA mount adapter into the stand.



2. Use the alignment pins to position the display onto the stand.



3. Insert the 20IP bit into the 2.5–25 Nm adjustable torque wrench.

4. Use the adjustable torque wrench and the 20IP bit to partially reinstall three 20IP screws in the order shown:

- (452-07329) (1, 2)
- (452-07330) (3)

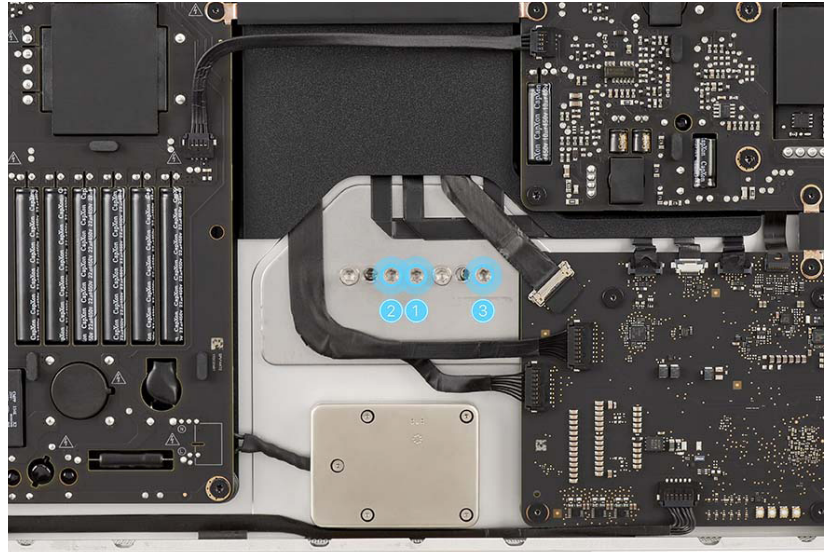

5. Set the torque value to 2.9 Nm. Use the adjustable torque wrench and 20IP bit to partially reinstall the two 20IP screws to 2.9 Nm in the order shown.



6. Use the adjustable torque wrench and 20IP bit to fully reinstall the right 20IP screw to 2.9 Nm.

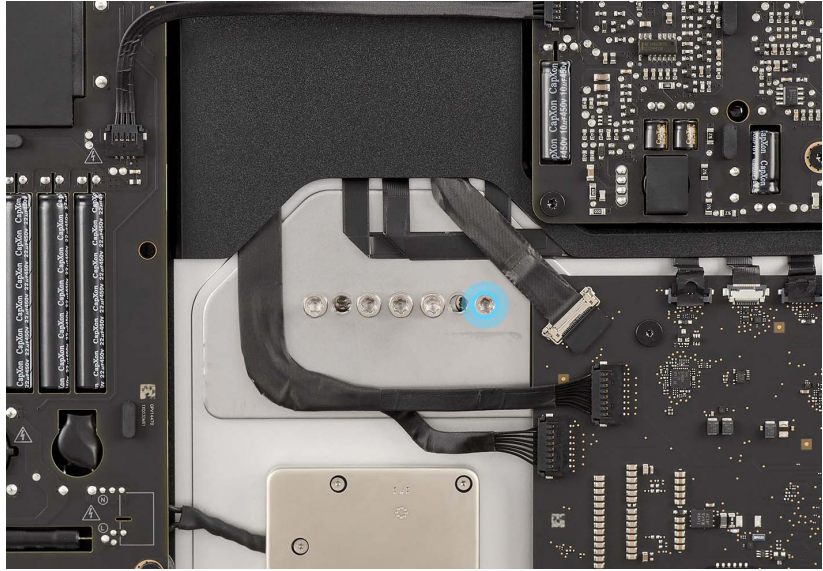

7. Remove the two alignment pins. Use the adjustable torque wrench and 20IP bit to partially reinstall two 20IP screws (452-07329) in the order shown.

Note: The alignment pins may get stuck. If they do, use a flathead screwdriver to remove the alignment pins.

8. Keep the 20IP bit in the 2.5–25 Nm adjustable torque wrench. Ensure that the torque value is still set to 2.9 Nm.
9. Use the adjustable torque wrench and 20IP bit to partially reinstall the two 20IP screws to 2.9 Nm in the order shown.

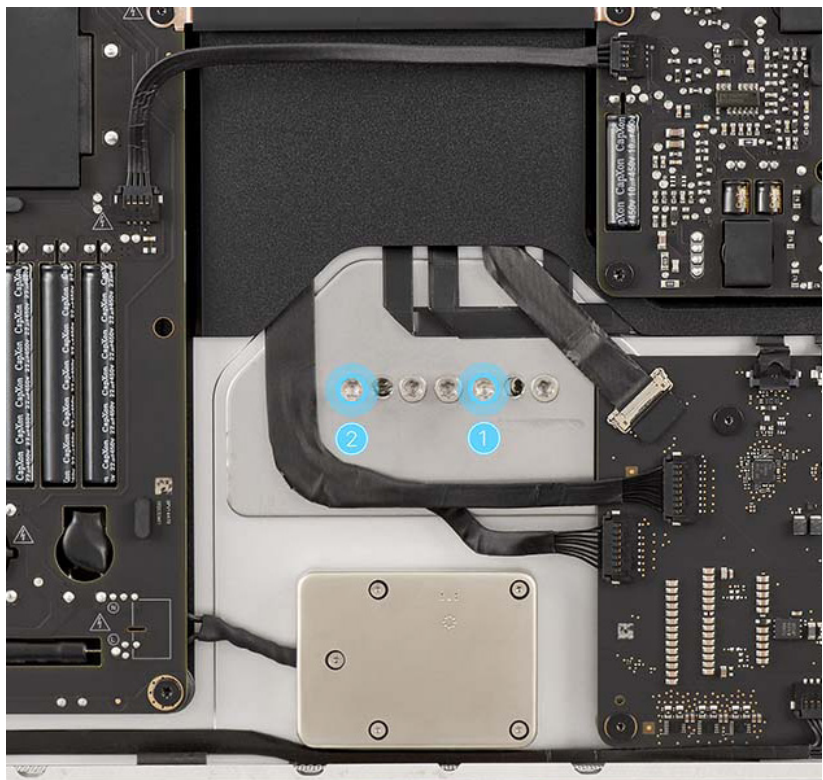

- Keep the 20IP bit in the 2.5–25 Nm adjustable torque wrench. Set the torque value to 6.4 Nm. Use the adjustable torque wrench and 20IP bit to fully reinstall the four 20IP screws in the order shown.

 **Caution**

Do not tighten the far right screw. It was set to the correct torque in a previous step.



Reinstall the following part to complete reassembly:

- [Display \(stand\)](#)

VESA Mount Adapter

Before You Begin



Ensure that the power cord is not plugged into an electrical outlet.

Remove the following parts before you begin:

- [Power cord](#)
- [Display \(VESA mount adapter\)](#)

Tools

- Adjustable torque wrench (2.5–25 Nm)
- Alignment pins for stand and VESA mount adapter
- Torx Plus 20IP 70 mm bit

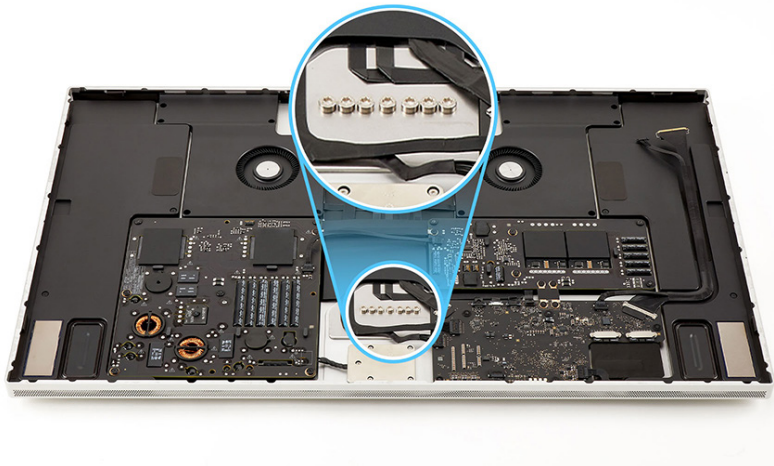

Removal

1. Lay the display flat on a table.
2. Insert the 20IP bit into the 2.5–25 Nm adjustable torque wrench. Use the adjustable torque wrench and 20IP bit to remove the seven 20IP screws (452-06742).



3. Lift the housing from the mount.

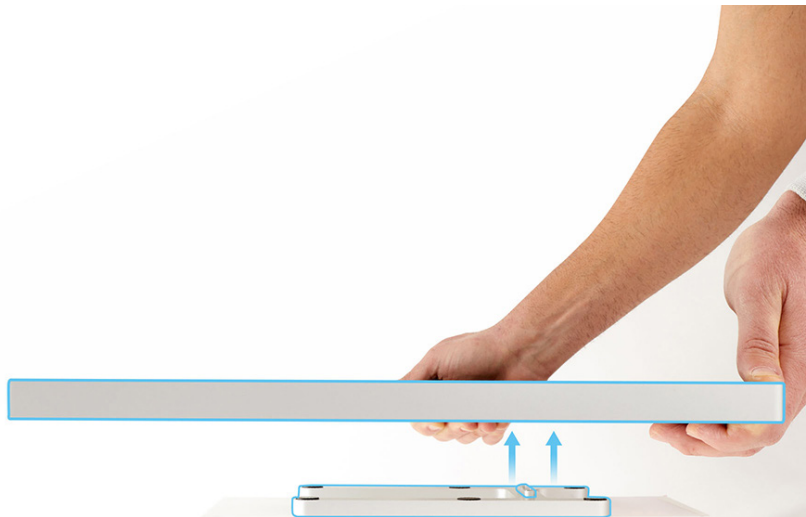

Reassembly

Important

- If you're installing a replacement VESA mount adapter, use the screws included with the replacement VESA mount adapter.
- To replace the VESA mount adapter with a tilt-adjustable stand, follow the reassembly steps in [Tilt-Adjustable Stand](#).
- To replace the VESA mount adapter with a tilt- and height-adjustable stand, follow the reassembly steps in [Tilt-and Height-Adjustable Stand](#).

1. Insert the flange into the mount adapter.

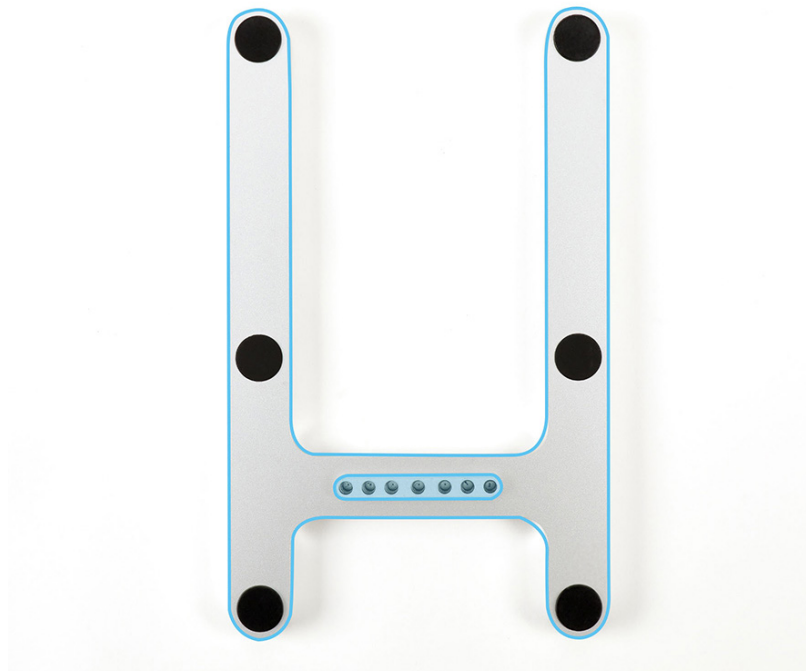

2. Install two alignment pins into the flange as shown.

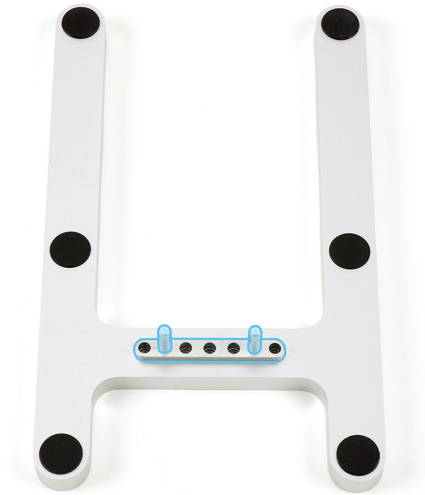

3. Use the alignment pins to position the display onto the mount adapter.

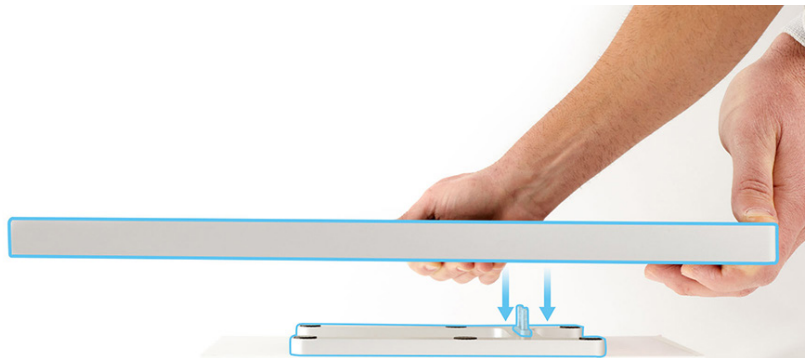

4. Use the 2.5–25 Nm adjustable torque wrench and 20IP bit to partially reinstall five 20IP screws (452-06742) in the order shown.



5. Keep the 20IP bit in the 2.5–25 Nm adjustable torque wrench. Set the torque value to 3.1 Nm.

6. Use the adjustable torque wrench and 20IP bit to fully reinstall the five 20IP screws in the order shown.



7. Remove the two alignment pins. Ensure that the 2.5–25 Nm adjustable torque wrench is still set to 3.1 Nm.

8. Use the adjustable torque wrench and 20IP bit to fully reinstall the two 20IP screws as shown.



Reinstall the following parts to complete reassembly:

- [Display \(VESA mount adapter\)](#)
- [Power cord](#)

Housing

Before You Begin



Ensure that the power cord is not plugged into an electrical outlet.

Remove the following parts before you begin:

- [Power cord](#)
- [Display \(stand\)](#) or [display \(VESA mount adapter\)](#)
- [USB-C boards](#)
- [Power supply boards](#)
- [Logic board](#)
- [Left fan](#)
- [Right fan](#)
- [Power cord port](#)
- [Cables](#)
- [Tilt-adjustable stand](#), [tilt- and height-adjustable stand](#), or [VESA mount adapter](#)

Tools

No tools are required for this procedure.

Removal



Place the housing on a clean, flat work surface or on a soft cloth to avoid damage.

There are no additional removal steps.

The housing includes the following nonremovable parts:

- Speakers
- Microphone

A replacement housing includes the following removable parts:

- Camera flex cable
- Microphone flex cable
- Display backlight cable
- Left fan flex cable
- Right fan flex cable
- Cable cover
- Screws for tilt-adjustable stand and tilt- and height-adjustable stand
- Screws for VESA mount adapter

Reassembly

Reinstall the following parts to complete reassembly:

- [Tilt-adjustable stand](#), [tilt- and height-adjustable stand](#), or [VESA mount adapter](#)
- [Cables](#)
- [Power cord port](#)
- [Right fan](#)
- [Left fan](#)
- [Logic board](#)
- [Power supply boards](#)
- [USB-C boards](#)
- [Display \(stand\)](#) or [display \(VESA mount adapter\)](#)
- [Power cord](#)

Torx® is a registered trademark of Acument Intellectual Properties, LLC.