



xmix 1002 FX USB

Thomann GmbH  
Hans-Thomann-Straße 1  
96138 Burgebrach  
Germany  
Telephone: +49 (0) 9546 9223-0  
Internet: [www.thomann.de](http://www.thomann.de)

19.02.2024, ID: 422793 (V2)

---

## Table of contents

<b>1</b>	<b>General information</b> .....	<b>5</b>
	1.1 Symbols and signal words.....	5
<b>2</b>	<b>Safety instructions</b> .....	<b>6</b>
<b>3</b>	<b>Features</b> .....	<b>8</b>
<b>4</b>	<b>Installation and starting up</b> .....	<b>9</b>
<b>5</b>	<b>Connections and controls</b> .....	<b>10</b>
<b>6</b>	<b>Technical specifications</b> .....	<b>16</b>
<b>7</b>	<b>Plug and connection assignment</b> .....	<b>18</b>
<b>8</b>	<b>Protecting the environment</b> .....	<b>20</b>





# 1 General information

This document contains important instructions for the safe operation of the product. Read and follow the safety instructions and all other instructions. Keep the document for future reference. Make sure that it is available to all those using the product. If you sell the product to another user, be sure that they also receive this document.

Our products and documentation are subject to a process of continuous development. They are therefore subject to change. Please refer to the latest version of the documentation, which is ready for download under [www.thomann.de](http://www.thomann.de).

## 1.1 Symbols and signal words

In this section you will find an overview of the meaning of symbols and signal words that are used in this document.

Signal word	Meaning
<b>DANGER!</b>	This combination of symbol and signal word indicates an immediate dangerous situation that will result in death or serious injury if it is not avoided.
<b>WARNING!</b>	This combination of symbol and signal word indicates a possible dangerous situation that can result in death or serious injury if it is not avoided.
<b>NOTICE!</b>	This combination of symbol and signal word indicates a possible dangerous situation that can result in material and environmental damage if it is not avoided.
Warning signs	Type of danger
	Warning – high-voltage.
	Warning – danger zone.

## 2 Safety instructions

### Intended use

This device is intended to be used for amplification, mixing and playback of signals from musical instruments and microphones. Use the device only as described in this user manual. Any other use or use under other operating conditions is considered to be improper and may result in personal injury or property damage. No liability will be assumed for damages resulting from improper use.

This device may be used only by persons with sufficient physical, sensorial, and intellectual abilities and having corresponding knowledge and experience. Other persons may use this device only if they are supervised or instructed by a person who is responsible for their safety.

### Safety



#### **DANGER!**

##### **Risk of injury and choking hazard for children!**

Children can suffocate on packaging material and small parts. Children can injure themselves when handling the device. Never allow children to play with the packaging material and the device. Always store packaging material out of the reach of babies and small children. Always dispose of packaging material properly when it is not in use. Never allow children to use the device without supervision. Keep small parts away from children and make sure that the device does not shed any small parts (such knobs) that children could play with.



#### **DANGER!**

##### **Danger to life due to electric current!**

Within the device there are areas where high voltages may be present. Never remove any covers. There are no user-serviceable parts inside. Do not use the device when covers, safety equipment or optical components are missing or damaged.



#### **DANGER!**

##### **Danger to life due to electric current!**

A short circuit could lead to a fire hazard and risk of death. Always use proper ready-made insulated triple-core mains cable with a safety plug. Do not modify the mains cable or the plug. In case of isolation damage, disconnect immediately the power supply and arrange repair. If in doubt, seek advice from a qualified electrician.



#### **WARNING!**

##### **Possible hearing damage due to high volumes on speakers or headphones!**

With speakers or headphones connected, the device can produce volume levels that may cause temporary or permanent hearing impairment. Over an extended period of time, even levels that seem to be uncritical can cause hearing damage. Do not operate the device permanently at a high volume level. Decrease the volume level immediately if you experience ringing in your ears or hearing impairment.



#### **NOTICE!**

##### **Risk of fire due to covered vents and neighbouring heat sources!**

If the vents of the device are covered or the device is operated in the immediate vicinity of other heat sources, the device can overheat and burst into flames. Never cover the device or the vents. Do not install the device in the immediate vicinity of other heat sources. Never operate the device in the immediate vicinity of naked flames.



#### **NOTICE!**

##### **Damage to the device if operated in unsuitable ambient conditions!**

The device can be damaged if it is operated in unsuitable ambient conditions. Only operate the device indoors within the ambient conditions specified in the "Technical specifications" chapter of this user manual. Avoid operating it in environments with direct sunlight, heavy dirt and strong vibrations. Avoid operating it in environments with strong temperature fluctuations. If temperature fluctuations cannot be avoided (for example after transport in low outside temperatures), do not switch on the device immediately. Never subject the device to liquids or moisture. Never move the device to another location while it is in operation. In environments with increased dirt levels (for example due to dust, smoke, nicotine or mist): Have the device cleaned by qualified specialists at regular intervals to prevent damage due to overheating and other malfunctions.



#### **NOTICE!**

##### **Damage to the device due to high voltages!**

The device can be damaged if it is operated with the incorrect voltage or if high voltage peaks occur. In the worst case, excess voltages can also cause a risk of injury and fires. Make sure that the voltage specification on the device matches the local power grid before plugging in the device. Only operate the device from professionally installed mains sockets that are protected by a residual current circuit breaker (FI). As a precaution, disconnect the device from the power grid when storms are approaching or it the device will not be used for a longer period.

**NOTICE!****Danger of short circuit due to use of unbalanced XLR cables!**

The device has a phantom voltage input. Using unbalanced cables with the phantom power may damage the device. Use only balanced cables. Before switching on phantom power, always make sure that no unbalanced wired cables are connected.

**NOTICE!****Risk of fire due to installation of a wrong fuse!**

Using fuses of a different type than compatible with the device may cause a fire and seriously damage the device. Only use fuses of the same type. Observe the labelling on the device casing and the information in the "Technical data" chapter.

**NOTICE!****Possible staining due to plasticiser in rubber feet!**

The plasticiser contained in the rubber feet of this product may react with the coating of the floor and cause permanent dark stains after some time. If necessary, use a suitable mat or felt slide to prevent direct contact between the device's rubber feet and the floor.

### 3 Features

- 8-channel mixer with built-in FX processor
- 4 mono channels (MIC, line) with low cut
- 3-band EQ and pan control
- 2 stereo channels with 2-band EQ and balance control
- Control room output L/R (1/4" jack)
- Additional input via RCA (stereo in / rec out)
- 1 × AUX control per channel, PRE/POST selectable
- PFL switch per channel
- Master output L/R via 2 × XLR and 2 × 1/4" phone socket
- Separately controllable headphones output (1/4" phone socket, stereo)
- Headphones output, adjustable together with CTRL room output
- USB port
- 48 V phantom power, globally switchable
- Built-in power supply

## 4 Installation and starting up

Unpack and check carefully there is no transportation damage before using the unit. Keep the equipment packaging. To fully protect the product against vibration, dust and moisture during transportation or storage use the original packaging or your own packaging material suitable for transport or storage, respectively.

Before connecting the supply voltage and before connecting or disconnecting audio cables, set all volume controls of the unit to zero to avoid damage to the connected speakers and devices.

## 5 Connections and controls

### Mono channel strip

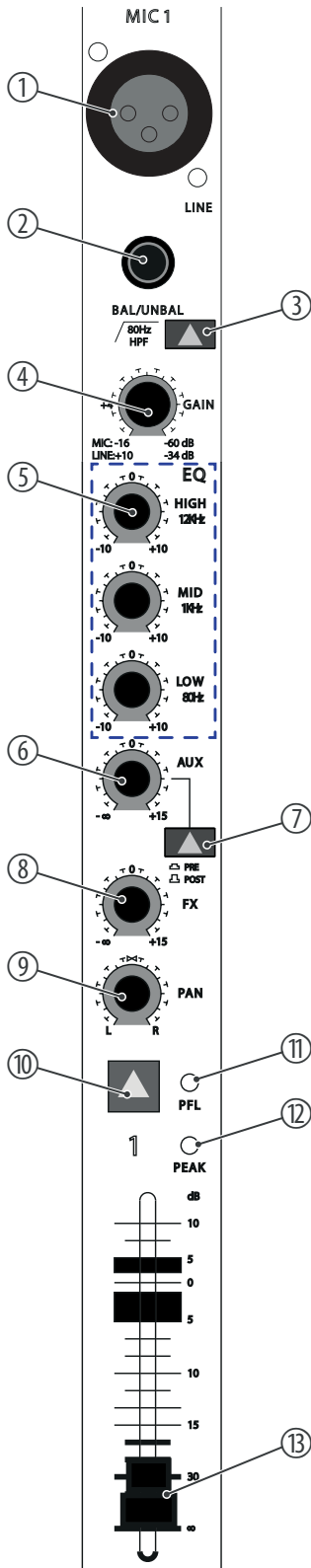

1	[MIC]   Balanced XLR mono input for connecting a microphone.
2	[LINE]   6.3-mm jack input for connecting a line level audio source (keyboards, drum modules etc., balanced or unbalanced).
3	[80 Hz HPF]   High pass filter to attenuate rumble noise and other low-frequency interferences.
4	[GAIN]   Rotary control for adjusting the input level.
5	[EQ]   3-band EQ for treble [HIGH], mids [MID] and bass [LOW].
6	[AUX]   Rotary control for adjusting the signal portion to be sent to the output [AUX SEND] to e.g. create a monitor mix.
7	[PRE / POST]   When this switch is pressed, the signal portion set with the [AUX] control is not affected by the channel fader ([PRE]). When the switch is not pressed, the AUX signal is subject to the channel fader ([POST]).
8	[FX]   Rotary control for adjusting the signal portion to be sent to the [FX SEND] output.
9	[PAN]   Rotary control for arranging the channel signal within the stereo panorama R/L.
10	[PFL] switch   When this switch is pressed, the channel signal is unaffected by the setting of the channel fader and present on the outputs [PHONES] and [CR OUT]. The switch does not affect the signal on the outputs [MAIN OUTPUT] and [REC OUT].
11	[PFL] LED   This LED lights up when the PFL function is activated.
12	[PEAK]   This LED lights up in case of channel overload. If this happens, turn the [GAIN] control to the left until this LED goes out.
13	The channel fader sets the strength of the channel signal in the overall signal.

Stereo channel strip

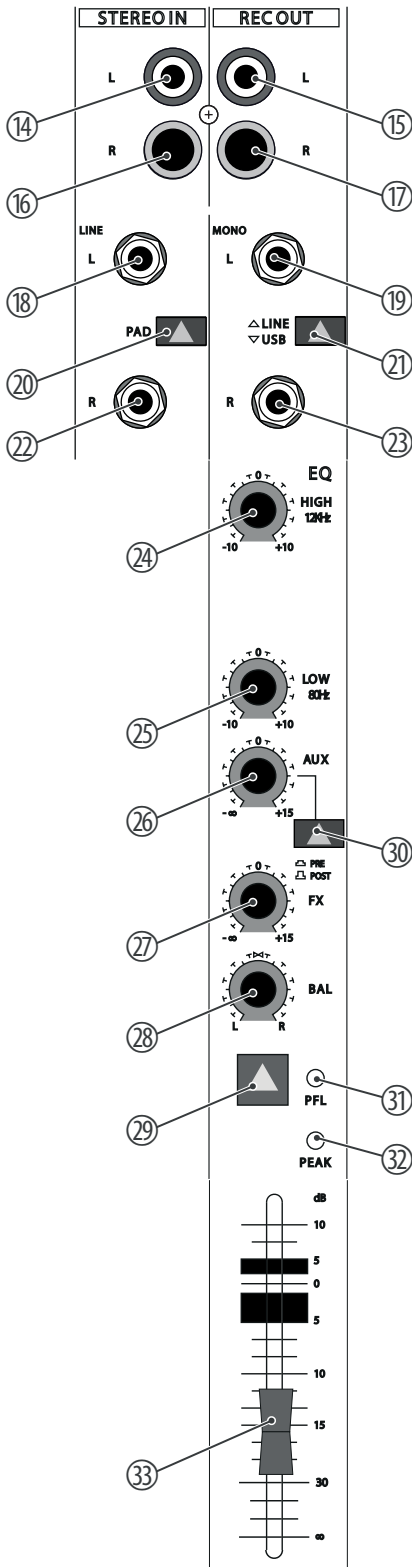

14, 16	[STEREO IN]   Cinch sockets for connecting stereo sources.
15, 17	[REC OUT]   Line outputs with cinch sockets for connecting recording devices.
18, 19	[L]   6.3-mm jack input for connecting the left stereo signal from a line level audio source (keyboards, drum modules etc.). With mono signals in the REC OUT channel, use this input and leave the [R] socket unused so the signal is present on both sum channels.
20	[PAD]   Switch for lowering the input sensitivity with particularly powerful signals.
21	[LINE   USB]   Switch for selecting the analogue line input R / L or the USB input.
22, 23	[R]   6.3-mm jack input for connecting the right stereo signal of a line level audio source (keyboards, drum modules etc.).
24, 25	[EQ]//[LOW]   2-band EQ for treble [HIGH] and bass [LOW].
26	[AUX]   Rotary control for adjusting the signal portion to be sent to the output [AUX SEND] to e.g. create a monitor mix.
27	[FX]   rotary control to adjust the signal portion to be sent to the [FX SEND] output.
28	[BAL]   Rotary control for arranging the channel signal within the stereo balance.
29	[PFL] switch   When this switch is pressed, the channel signal is unaffected by the setting of the channel fader and the internal effects section, and is present on the outputs [PHONES] and [CR OUT]. The switch does not affect the signal on the outputs [MAIN OUTPUT] and [REC OUT].
30	[PRE / POST]   When this switch is pressed, the signal portion set with the [AUX] control is not affected by the channel fader ([PRE]). When the switch is not pressed, the AUX signal is subject to the channel fader ([POST]).
31	[PFL] LED   This LED lights up when the PFL function is activated.
32	[PEAK]   This LED lights up in case of channel overload. If this happens in the STEREO IN channel press the [PAD] switch. When overload occurs in the REC-OUT channel, reduce the output level of the signal source connected here.
33	The channel fader sets the strength of the channel signal in the overall signal.

## Effects section, AUX

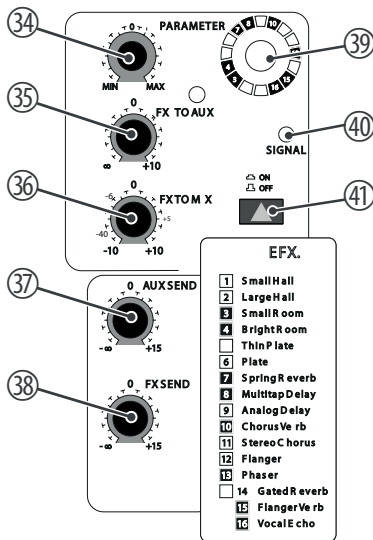

- 34 [PARAMETER] | Rotary control for setting the main parameter of the currently selected effect.
- 35 [FX TO AUX] | Rotary control for adjusting the effects portion present on the [AUX SEND] output.
- 36 [FX RETURN TO MIX] | Rotary control for adjusting the effects portion in the sum signal.
- 37 [AUX SEND] | Rotary control for adjusting the overall level on the [AUX SEND] output.
- 38 [FX SEND] | Rotary control for adjusting the overall level on the [FX SEND] output.
- 39 [1 - 16] | Rotary control for selecting the required effect, see the printed [EFX.] list under the 'ON | OFF' switch.
- 40 [SIGNAL] | When this LED lights up a signal is present on the input of the effect section.
- 41 [ON | OFF] | Button for switching the effect function on and off.

## Master section

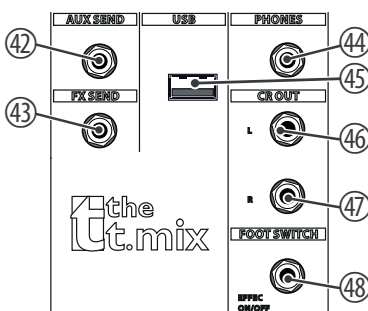

- 42 [AUX SEND] | This line level output has the signal that was set with the [AUX] channel controls and can be used, for example, to create a monitor mix.
- 43 [FX SEND] | This line level output has the signal that was set with the [FX] channel controls and can be sent to an external effects device, for example.
- 44 [PHONES] | Stereo headphone output
- 45 [USB] | USB port for feeding in digital audio signals or for the digital output of the sum signal, unaffected by the master faders.
- 46 [CR OUT L] | Control room output for connecting amplifiers or active speakers.
- 47 [CR OUT R] | Control room output for connecting amplifiers or active speakers.
- 48 [FOOT SWITCH EFFECT] | Socket for connecting a foot switch (not supplied), which can be used to switch the internal effects section on and off.

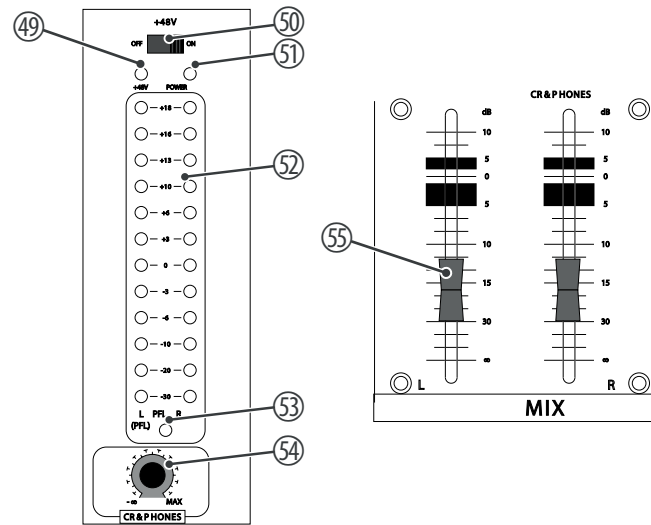

49	[+48V] LED   This LED lights up when the phantom power is on.
50	[+48V] switch   When this switch is in the ON position, a phantom voltage of 48 V $\overline{\text{DC}}$ is present on the XLR sockets in the mono channels for using condenser microphones. If no condenser microphones are used, the switch should be in the OFF position. The phantom voltage must not be switched on if an unbalanced XLR cable is connected to one of the MIC inputs.
51	[POWER]   This LED lights up when the device is on.
52	[LEDs]   These LED chains indicate the level of the sum signal. Keep the level within a range below +18. The red LEDs light up if there is an overload. In this case, pull back the two master faders so that the red LEDs do not light up any more. If the PFL button is pressed in one of the channels, the signal in this channel is displayed in the left LED chain, regardless of the channel fader.
53	[PFL]   This LED lights up when the [PFL] button is pressed in at least one of the channels and thus the LED chains do not display the sum signal.
54	[CR & PHONES]   Rotary control for adjusting the level on the outputs [CR OUT] and [PHONES].
55	[L MIX R]   Master fader for adjusting the sum level on the outputs [MAIN OUTPUT], [CR OUT] and [PHONES].

## Back

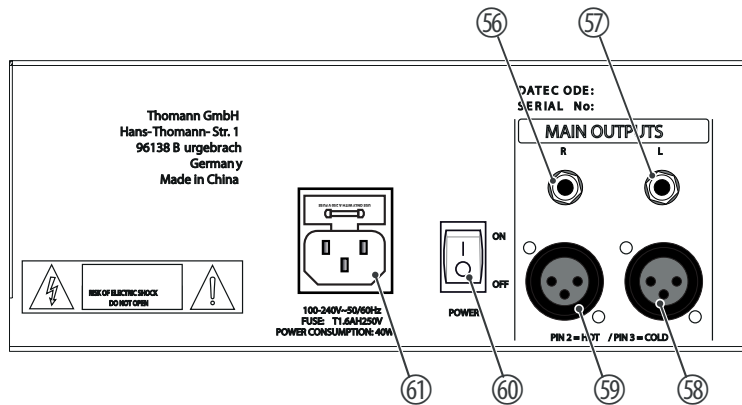

56.57	[MAIN OUTPUTS]   Balanced 6.3-mm jack outputs for connecting power amplifiers, effects devices or recording devices
58.59	[MAIN OUTPUTS]   Balanced XLR outputs for connecting power amplifiers, effects devices or recording devices.
60	[POWER]   Main switch for turning the device on and off.
61	Rubber panel plug for mains connection with fuse holder.

## Connection example – club gig

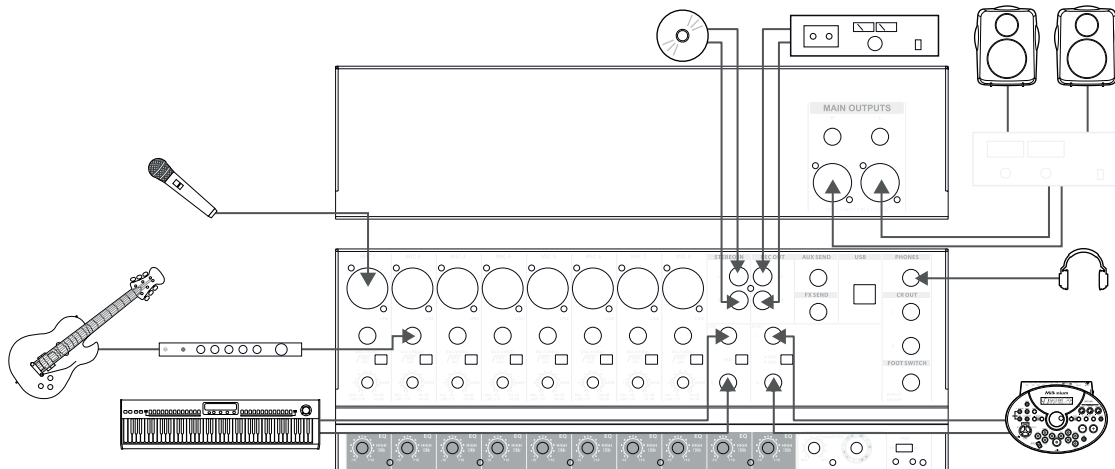

Connection example – PC home recording

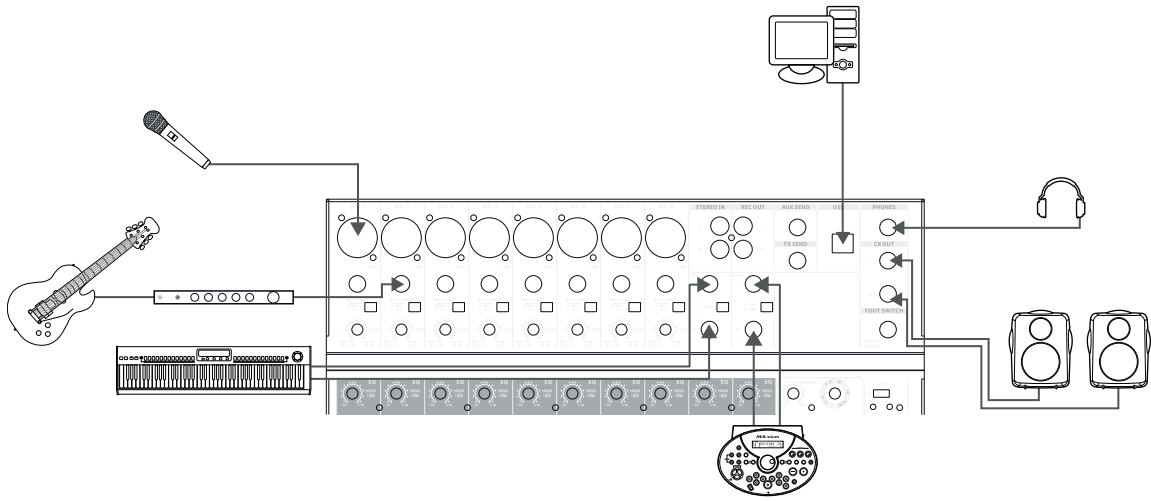

## 6 Technical specifications

Input connections	Power supply		C14 rubber panel plug
	Microphone input	Type	4 × XLR panel socket, 3-pin, balanced
		Level	max. + 4 dBu ± 1 dBu
		Impedance	6 kΩ, balanced 3 kΩ ±200 Ω, unbalanced
	Line input	Type	4 × 6.3-mm jack socket, balanced or unbalanced
		Level	max. + 21 dBu ± 1 dBu
		Impedance	44 kΩ, balanced 22 kΩ ±2 kΩ, unbalanced
	Stereo input	Type	2 × cinch sockets
		Level	max. + 21 dBu ± 1 dBu
		Impedance	44 kΩ, balanced 22 kΩ ±2 kΩ, unbalanced
	Stereo line level input	Type	4 × 6.3-mm jack socket
		Level	max. +21 dBu ± 1 dBu
		Impedance	44 kΩ, balanced 22 kΩ ±2 kΩ, unbalanced
Foot switch	Type	6.3-mm jack socket	
USB port	Type	USB 2.0	
Output connections	Master output	Type	2 × 6.3-mm jack socket, balanced
		Level	+26 dBu ± 1 dBu
		Impedance	200 Ω
	Master output	Type	2 × XLR panel socket, 3-pin, balanced
		Level	+21 dBu ± 1 dBu +26 dBu ± 1 dBu
		Impedance	200 Ω
	Line output	Type	2 × cinch sockets
	Line level output	Type	2 × 6.3-mm jack socket
	Control room output	Type	2 × 6.3-mm jack socket
Stereo headphone output	Type	6.3-mm jack socket	
	Level	150 mW ± 5 mW @ 32 Ω	
EQ	Treble		+/- 10 dB, ± 1.5 dB @ 12 kHz shelving
	Mids		+/- 10 dB, ± 1.5 dB @ 1 kHz shelving
	Bass		+/- 10 dB ± 1.5 dB @ 80 Hz shelving

Effects	16 in total	2 × hall reverb 2 × room reverb 2 × plate reverb 1 × spring reverb 2 × delay 2 × chorus Flanger Phaser Gated reverb Flanger reverb Vocal echo
Signal gain mono channel	Mic input, adjustable	44 dB (−16 ~ −60 dB)
	Line	−10 dB ~ + 34 dB
Frequency range		20 Hz ~ 20 kHz ± 2 dB
Signal-to-noise ratio	Mic equivalent residual noise	128 dB ± 5 dB
	Residual noise	86 dB ± 5 dB
Total harmonic distortion (THD)		< 0.025% at +14 dBu ± 0.5 dBu
Phantom power		48 V ± 2 V
Common mode rejection		63 dB ± 3 dB @ 1 kHz
Power consumption		40 W
Supply voltage		100 - 240 V ~, 50/60 Hz
Fuse		5 mm × 20 mm, 1.6 A, 250 V, slow blow
Dimensions (W × H × D)		265 mm × 100 mm × 340 mm
Weight		3.85 kg
Ambient conditions	Temperature range	0 °C...40 °C
	Relative humidity	20%...80%, non-condensing

## 7 Plug and connection assignment

### Introduction

This chapter will help you select the right cables and plugs to connect your valuable equipment in such a way that a perfect sound experience is ensured.

Please note these advices, because especially in 'Sound & Light' caution is indicated: Even if a plug fits into the socket, an incorrect connection may result in a destroyed power amp, a short circuit or 'just' in poor transmission quality!

### Balanced and unbalanced transmission

Unbalanced transmission is mainly used in semi-professional environment and in hifi use. Instrument cables with two conductors (one core plus shielding) are typical representatives of the unbalanced transmission. One conductor is ground and shielding while the signal is transmitted through the core.

Unbalanced transmission is susceptible to electromagnetic interference, especially at low levels, such as microphone signals and when using long cables.

In a professional environment, therefore, the balanced transmission is preferred, because this enables an undisturbed transmission of signals over long distances. In addition to the conductors 'Ground' and 'Signal', in a balanced transmission a second core is added. This also transfers the signal, but phase-shifted by 180°.

Since the interference affects both cores equally, by subtracting the phase-shifted signals, the interfering signal is completely neutralized. The result is a pure signal without any noise interference.

### 1/4" TS phone plug (mono, unbalanced)



1	Signal
2	Ground, shielding

### 1/4" TRS phone plug (mono, balanced)



1	Signal (in phase, +)
2	Signal (out of phase, -)
3	Ground

### 1/4" TRS phone plug (stereo, unbalanced)



1	Signal (left)
2	Signal (right)
3	Ground

**XLR plug (balanced)**

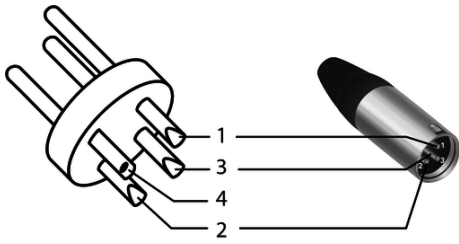

1	Ground, shielding
2	Signal (in phase, +)
3	Signal (out of phase, -)
4	Shielding on plug housing (option)

**XLR plug (unbalanced)**

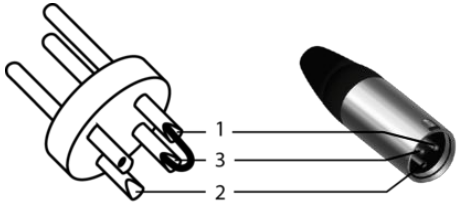

1	Ground, shielding
2	Signal
3	Bridged to pin 1

**RCA connection**



Drawing and table indicate the pin assignment of an RCA plug.

1	Signal
2	Ground, shielding

## 8 Protecting the environment

### Disposal of the packing material

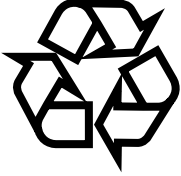

Environmentally friendly materials have been chosen for the packaging. These materials can be sent for normal recycling. Ensure that plastic bags, packaging, etc. are disposed of in the proper manner.

Do not dispose of these materials with your normal household waste, but make sure that they are collected for recycling. Please follow the instructions and markings on the packaging.

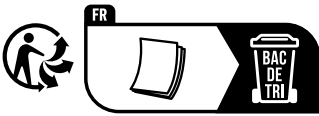

Observe the disposal note regarding documentation in France.

### Disposal of your old device

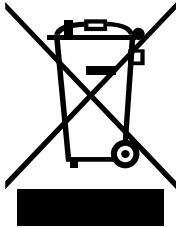

This product is subject to the European Waste Electrical and Electronic Equipment Directive (WEEE) as amended.

Do not dispose of your old device with your normal household waste; instead, deliver it for controlled disposal by an approved waste disposal firm or through your local waste facility. When disposing of the device, comply with the rules and regulations that apply in your country. If in doubt, consult your local waste management facility. Proper disposal protects the environment as well as the health of your fellow human beings.

Also note that waste avoidance is a valuable contribution to environmental protection. Repairing a device or passing it on to another user is an ecologically valuable alternative to disposal.

You can return your old device to Thomann GmbH at no charge. Check the current conditions on [www.thomann.de](http://www.thomann.de).

If your old device contains personal data, delete those data before disposing of it.







