

User's Manual

FLEX plus

SOUND ENHANCEMENT
PROCESSOR

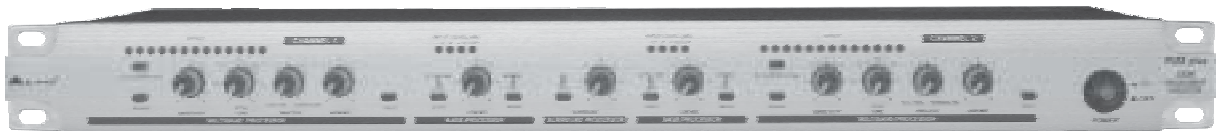

www.altoproaudio.com
Version 1.3 October 2005

— English —

SAFETY RELATED SYMBOLS



This symbol, wherever used, alerts you to the presence of un-insulated and dangerous voltages within the product enclosure. These are voltages that may be sufficient to constitute the risk of electric shock or death.



This symbol, wherever used, alerts you to important operating and maintenance instructions. Please read.



Protective Ground Terminal



AC mains (Alternating Current)



Hazardous Live Terminal

ON: Denotes the product is turned on.

OFF: Denotes the product is turned off.

WARNING

Describes precautions that should be observed to prevent the possibility of death or injury to the user.

CAUTION

Describes precautions that should be observed to prevent damage to the product.



Disposing of this product should not be placed in municipal waste and should be placed in a separate collection.

WARNING

• Power Supply

Ensure that the mains source voltage (AC outlet) matches the voltage rating of the product. Failure to do so could result in damage to the product and possibly the user.

Unplug the product before electrical storms occur and when unused for long periods of time to reduce the risk of electric shock or fire.

• External Connection

Always use proper ready-made insulated mains cabling (power cord). Failure to do so could result in shock/death or fire. If in doubt, seek advice from a registered electrician.

• Do Not Remove Any Covers

Within the product are areas where high voltages may present. To reduce the risk of electric shock do not remove any covers unless the AC mains power cord is removed.

Covers should be removed by qualified service personnel only.

No user serviceable parts inside.

• Fuse

To prevent fire and damage to the product, use only the recommended fuse type as indicated in this manual. Do not short-circuit the fuse holder. Before replacing the fuse, make sure that the product is OFF and disconnected from the AC outlet.

• Protective Ground

Before turning the product ON, make sure that it is connected to Ground. This is to prevent the risk of electric shock.

Never cut internal or external Ground wires. Likewise, never remove Ground wiring from the Protective Ground Terminal.

• Operating Conditions

Always install in accordance with the manufacturer's instructions.

To avoid the risk of electric shock and damage, do not subject this product to any liquid/rain or moisture. Do not use this product when in close proximity to water.

Do not install this product near any direct heat source.

Do not block areas of ventilation. Failure to do so could result in fire.

Keep product away from naked flames.

IMPORTANT SAFETY INSTRUCTIONS

Read these instructions

Follow all instructions

Keep these instructions. Do not discard.

Heed all warnings.

Only use attachments/accessories specified by the manufacturer.

• Power Cord and Plug

Do not tamper with the power cord or plug. These are designed for your safety.

Do not remove Ground connections!

If the plug does not fit your AC outlet seek advice from a qualified electrician.

Protect the power cord and plug from any physical stress to avoid risk of electric shock.

Do not place heavy objects on the power cord. This could cause electric shock or fire.

• Cleaning

When required, either blow off dust from the product or use a dry cloth.

Do not use any solvents such as Benzol or Alcohol. For safety, keep product clean and free from dust.

• Servicing

Refer all servicing to qualified service personnel only.

Do not perform any servicing other than those instructions contained within the User's Manual.

PREFACE

Dear Customer:

Thanks for choosing FLEX plus Sound Enhancement Processor and thanks for choosing one of the results of ▲LTO AUDIO TEAM job and researches.

For our ▲LTO AUDIO TEAM, music and sound are more than a job...are first of all passion and let us say...our obsession!

We have been designing professional audio products for a long time in cooperation with some of the major brands in the world in the audio field.

The ▲LTO line presents unparalleled analogue and digital products made by Musicians for Musicians in our R&D Centres in Italy, Netherlands, United Kingdom and Taiwan. The core of our digital audio products is a sophisticated DSP (Digital Sound Processor) and a large range of state of the art algorithms which have been developed by our Software Team for the last 7 years.

Because we are convinced you are the most important member of ▲LTO AUDIO TEAM and the one confirming the quality of our job, we like to share with you our work and our dreams, paying attention to your suggestions and your comments.

Following this idea we create our products and we will create the new ones! From our side, we guarantee you and we will guarantee you also in future the best quality, the best fruits of our continuous researches and the best prices. Our FLEX PLUS is the result of many hours of listening and tests involving common people, area experts, musicians and technicians.

The result of this effort is that you can acquire an extremely efficient and universal dynamics processor. It contains several circuit designs which make the unit an ultimate dynamic processor: multi-band processor, bass processor and surround processor, which can produce a more lively, transparent and natural sound signal.

Nothing else to add, but that we would like to thank all the people that made the FLEX plus a reality available to our customers, and thank our designers and all the ▲LTO staff, people who make possible the realization of products containing our idea of music and sound and are ready to support you, our customers, in the best way, conscious that you are our best richness.

Thank you very much.

▲LTO AUDIO TEAM

TABLE OF CONTENTS

1. INTRODUCTION	4
2. FEATURE LIST	4
3. CONTROL ELEMENTS	4
3.1 The Front Panel	
3.1.1 MULTIBAND PROCESSOR Section	
3.1.2 BASS PROCESSOR Section	
3.1.3 SURROUND PROCESSOR Section	
3.2 The Rear Panel	
4. INSTALLATION AND CONNECTION	7
4.1 Mains Connection	
4.2 Audio Connection	
4.3 Rack Mounting	
5. APPLICATION	9
6. TECHNICAL SPECIFICATION	11
7. BLOCK DIAGRAM	12
8. WARRANTY	13

1. INTRODUCTION

Thank you very much for expressing your confidence in ▲LTO products by purchasing our FLEX plus Sound Enhancement Processor.

With the FLEX plus you have acquired a powerful Sound Enhancement Processor which is based on many years of experience and findings in processor technology and is used through the world in renowned studios. The FLEX plus meets highest and non-compromise requirements in terms of operation, sound, specifications and workmanship.

The FLEX plus is able to provide better stereo effect and increase the transparency and presence of sound. It can precisely modify the bass "contour" for more lively and natural sound. For more detailed information, please read this manual carefully.

2. FEATURE LIST

- Mountable in one standard unit 19"
- Illuminated power switch
- Automatically reducing unwanted noise in the system
- Multi-band processor for bass and high frequency transparency
- Bass processor compensates power loss in the bass with its selectable-frequency phase shift and sub-bass enhancement
- Surround processor improves the intensity of the stereo effect and provides a more ambient and spatial music field
- Balanced XLR and 1/4" TRS connectors available for inputs and outputs
- High quality components and rigid configuration for long life and full credibility
- Manufactured under QS9000, VDA6.1 certified management system

3. CONTROL ELEMENTS

3.1 The Front Panel

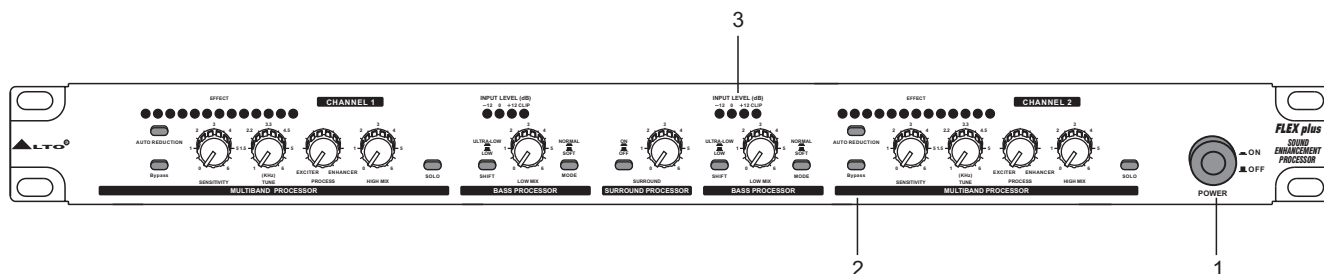

Your ▲LTO FLEX plus presents with surround processor and two identical channels, and each channel is equipped with the multi-band processor and bass processor, which contains 5 push-button switches, 5 rotary controls and 17 LEDs.

1. POWER Switch

Turn the apparatus ON or OFF.

2. BYPASS Switch

Engaging this switch will bypass the corresponding channel, the input signal will be routed to output directly. It is used to compare quickly the processed and unprocessed signal.

3. INPUT LEVEL Meter

The meter informs you the input level, with a range of -12dB to +12dB. The CLIP LED will light up when the distortion occurs in the circuit.

3.1.1 MULTIBAND PROCESSOR Section

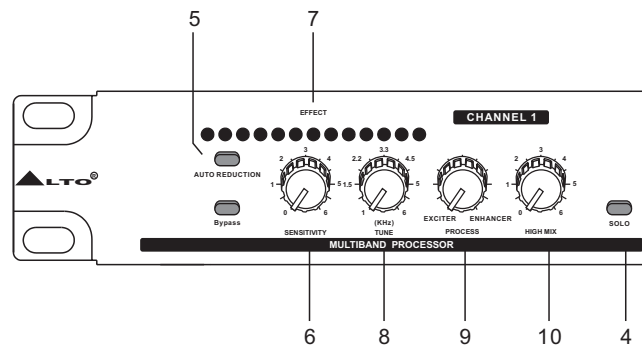

4. SOLO Switch

Engaging this switch is used to select the solo mode, and the switch is turned into red. It is used to mute the original signal from main mix signal.

5. AUTO REDUCTION Switch

Engage this switch to activate the auto reduction function, which is used to reduce the undesired noise in the system. If releasing the switch, the auto reduction function will have no any effect on the unit, then the FLEX plus works under the maximum effect, and all EFFECT LEDs will light up.

6. SENSITIVITY Control

In order to achieve the proper effect, you can rotate this control to adjust the sensitivity for input signal depending on the EFFECT LED display.

7. EFFECT LED Display

These LEDs will inform you the actually effect change and the amount of sound enhancement. The first LED is always illuminated even at low-level signals.

8. TUNE Control

Through adjusting this control to select the proper cutoff frequency for high pass filter (or low-cut filter, which is used to reduce or eliminate the frequencies below the cutoff frequency) within a range of 1kHz to 6kHz.

9. PROCESS Control

Through rotating this control to achieve an increase in apparent loudness in the high frequencies well. There are two settings: clockwise for enhancer setting; counterclockwise for exciter setting. The only difference is intensity of increasing between the two settings.

10. HIGH MIX Control

This control is used to adjust the amount of high frequency signal for sound enhancement. It covers a range from 0 to 6.

3.1.2 BASS PROCESSOR Section

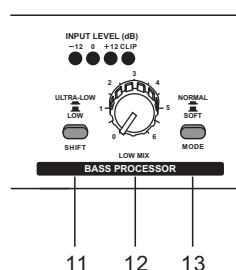

11. SHIFT Switch

Through this switch to select the cutoff frequency for low pass filter (or high cut filter) between the LOW and ULTRA-LOW.

12. LOW MIX Control

This control is used to adjust the amount of low frequency signal for sound enhancement. It covers a range of 0 to 6.

13. MODE Switch

This switch provides two effect modes for bass processor: up for SOFT mode; down for NORMAL mode. In the SOFT mode, the bass will go through gentle processing, you will hear the bass with very warm and natural; otherwise, the bass will sound dry and coarse.

3.1.3 SURROUND PROCESSOR Section

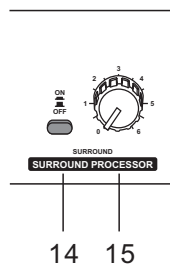

14. SURROUND Switch

Engaging this switch will activate the surround processor function, which is used to make the cross talk between the CHANNEL 1 and CHANNEL 2, hence, the function can be used only in linking with stereo program material. If you don't want to add this effect to signal path, please let the switch free.

15. SURROUND Control

Rotate this control to adjust the intensity of cross talk effect between the two channels within a range of 0 to 6. Clockwise for increasing the stereo effect, otherwise, for reducing the stereo effect.

3.2 The Rear Panel

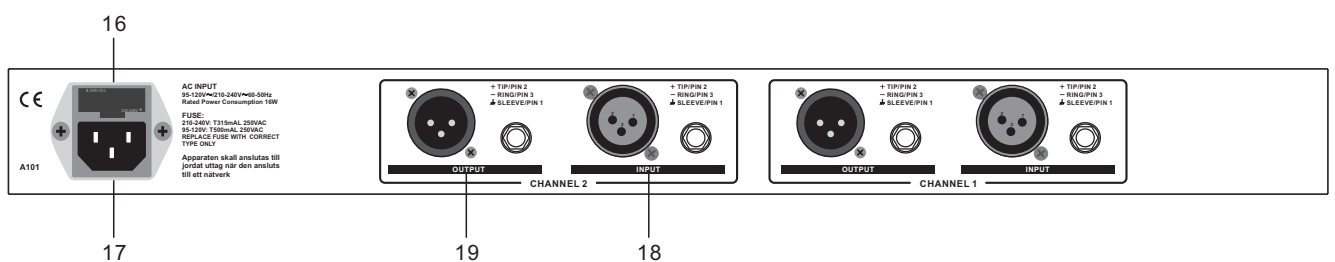

16.FUSE Holder/Voltage Selector

This is a dual voltage unit. Before you attempt to connect and operate the unit, please make sure that your local voltage matches the voltage on the fuse-holder cover.

Caution: The fuse protecting the AC supplies circuits of this unit. The fuse can only be changed by a qualified technician, in the event of a fault or changing the supply voltage. If the fuse continues to blow after replacing, discontinue use of this unit before repaired.

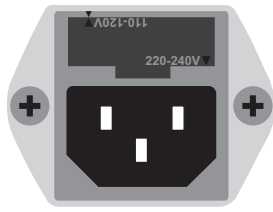

THIS IS SET FOR
110V AC TO 120V
AC OPERATION

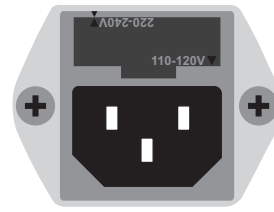

THIS IS SET FOR
220V AC TO 240V
AC OPERATION

The fuse-holder above the AC connector on the rear of the chassis has 3 triangular markers(please refer to the above pictures), with two of these triangles opposing each other, your unit is set to the operating voltage printed next to these markers.

To change, pull fuse-holder out and rotate 180°, then push in again.

17.AC Inlet

This connector is used to connect the supplied power cord. Please don't plug power cord into this unit and AC power if voltage has not been correctly set.

18. Audio In

These connectors are used to input the signal source. You can input the signal via the balanced 1/4" TRS phone jack or XLR connector.

19. Audio Out

These connectors are used to output the signal source. You can output the signal via the balanced 1/4" TRS phone jack or XLR connector.

4. INSTALLATION AND CONNECTION

4.1 Mains Connection

FLEX plus is provided with dual voltage plug. You must check the power supply voltage available in your country before connecting the power cord in the wall outlet.

4.2 Audio Connection

The FLEX plus Sound Enhancement Processor is equipped with balanced XLR connectors as well as 1/4" phone jack and can be connected with other units in different ways to support a vast range of applications without experiencing a signal loss.

a. Wiring Configuration

Both types of connectors available on FLEX plus can be wired in balanced and unbalanced modes. Please see following drawing for details.

- For 1/4" Phone jack

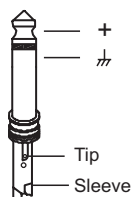

TS Type Unbalanced

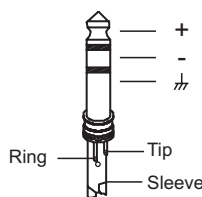

TRS Type Balanced

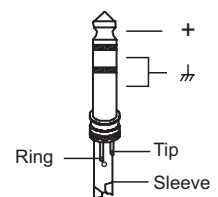

TRS Type Unbalanced

- For XLR connector

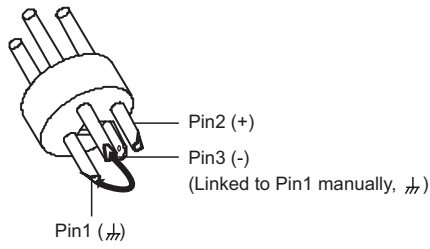

XLR Type Unbalanced

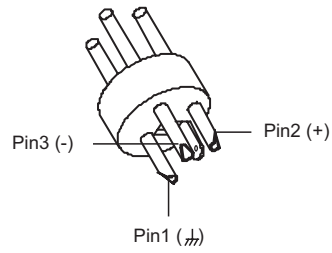

XLR Type Balanced

b. In Line Connection

Please see following drawing for details.

- Balanced

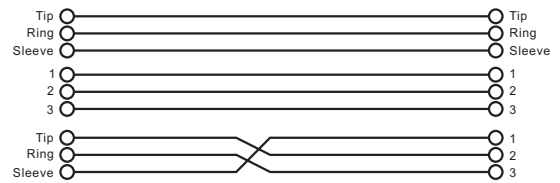
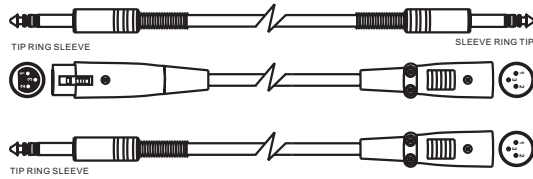

- Unbalanced

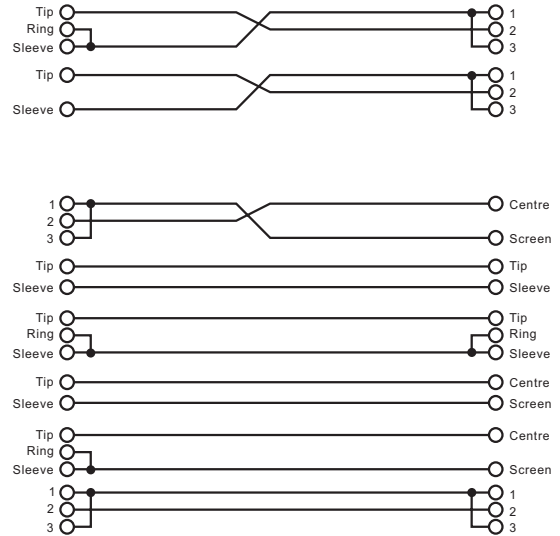
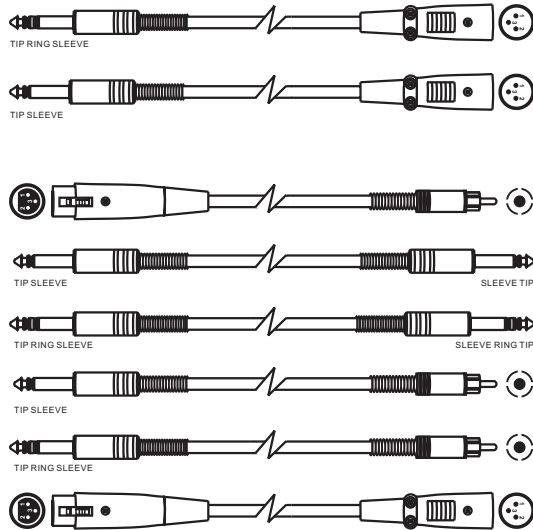

c. Insert Points Connection

In case you are using the main inserts of your mixing console and you have a single jack for SEND and RETURN, you can use an insert Y cable. Please see following drawing.

- 1/4" TRS insert

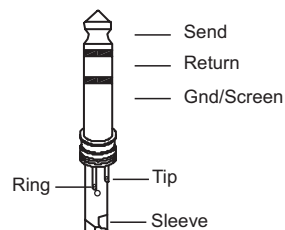

- Insert Leads

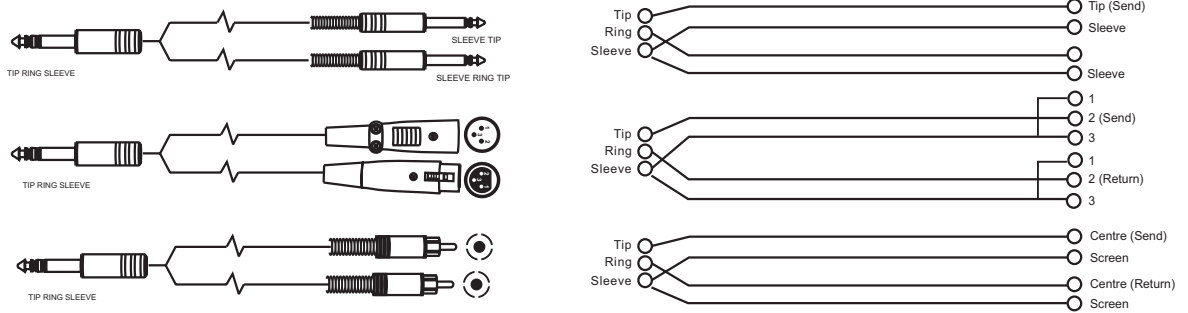

4.3 Rack Mounting

The most secure mounting is on a universal rack shelf available from various rack manufactures or your music dealer. The FLEX plus Sound Enhancement Processor fits into one standard 19" rack unit of space.

Please allow at least an additional 4" depth for the connectors on the rear panel. Be sure that there is enough air space around the unit for sufficient ventilation and please do not place the FLEX plus Sound Enhancement Processor on high temperature devices such as power amplifiers etc. to avoid overheating.

5. APPLICATION

This chapter introduce how to wire and use your FLEX plus in typical studio and live applications. As mentioned earlier, the FLEX plus is a sound enhancement processor, which is used to polish the program materials. So you can use it to enrich the sound, enhance the effect of surrounding stereo signal and compensate the loss in the low frequency, thus, the high frequency of program materials will become more and more clear, transparent; the low frequency is more warm.

So your FLEX plus sound enhancement processor is necessary tool, and can be available in many fields such as: it can be regarded as in line processor to enhance treble and bass in system separately; or it can be also regarded as the effects device to make some specific effects etc..

Before operating, please goes through the following contents, it will give you some good ideas.

- Please release the channel's bypass switch. If you want to operate with stereo program material, the both bypasses must be released.
- Please make sure that the all EFFECT LEDs light up when releasing the Auto Reduction switch, but when depressing the switch, the first LED always be lighted up even at low-level signals.
- Please keeps the sensitivity at a high value especially for low-level signals, so it can avoid unwanted noise occurred.
- Please make sure that the enhancer setting is available for increasing signal's transparency and sharpness; the exciter setting is available for percussion instrument.
- In order to avoid the unexpected speaker damage, please adjust the bass processor carefully.
- Engage the Solo switch to mute the original signal

In this chapter, we also provide two configurations about the basic wiring for FLEX plus in system, for further details, please refer to following figures.

- As In-Line Processor

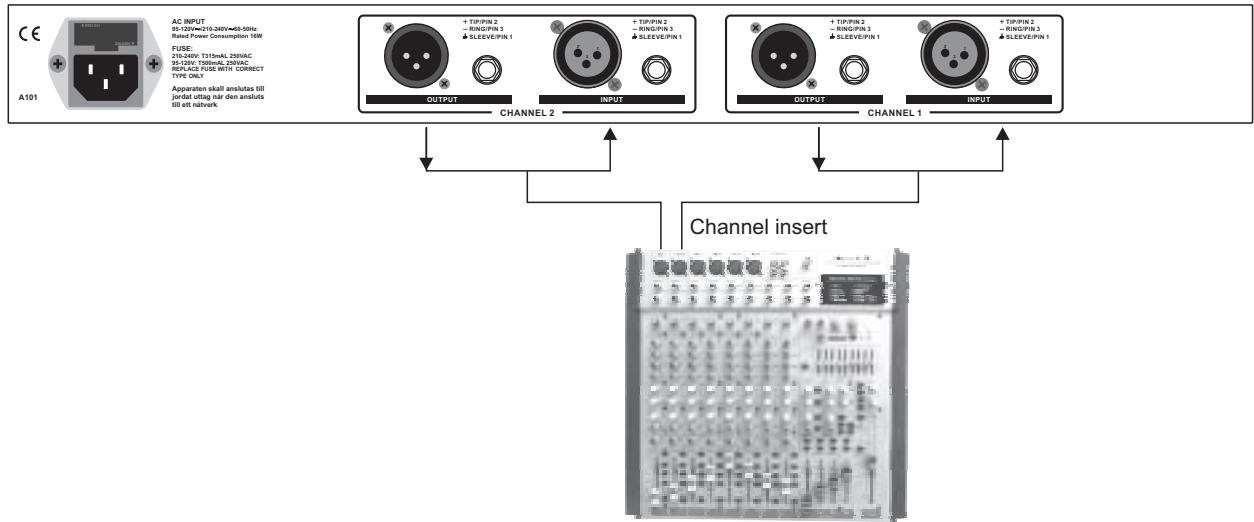

- As Effects Device

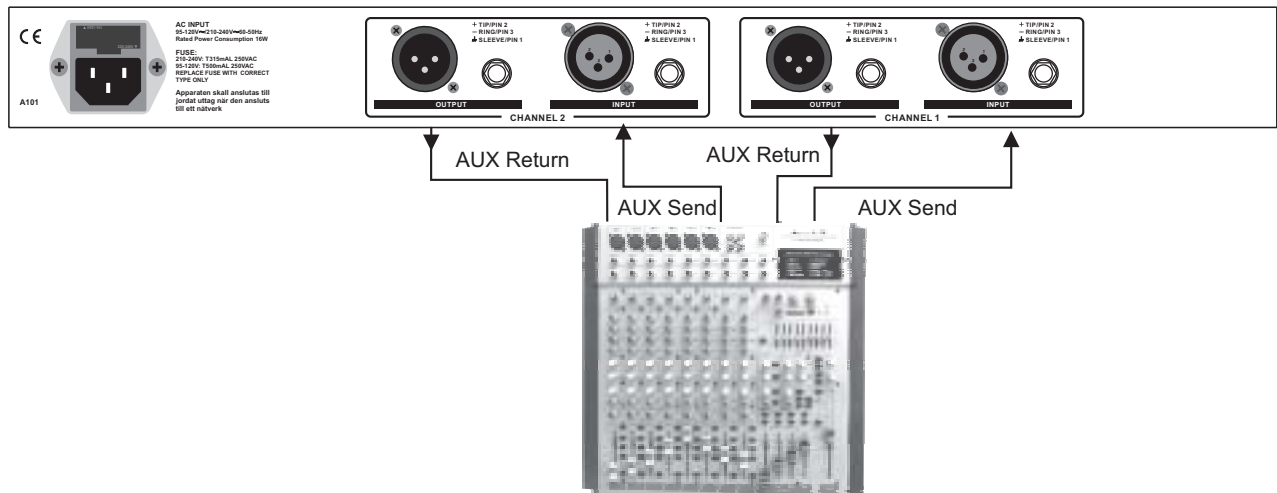

6. TECHNICAL SPECIFICATIONS

AUDIO INPUT	Connectors	XLR and 1/4" TRS
	Type	RF filtered, servo-balanced input
	Max. Input Level	Balanced and Unbalanced: +21 dBu (unity gain)
	Impedance	Balanced: 50kOhm Unbalanced: 25kOhm
	CMRR	typ.40dB, >55dB@1kHz
AUDIO OUTPUT	Connectors	XLR and 1/4" TRS
	Type	Electronically servo-balanced output stage (optional transformer-balanced). Automatic level correction for unbalanced use (6dB).
	Max. Output Level	Balanced and Unbalanced: +21 dBu, +20 dBm
	Impedance	Balanced: 60 Ohm Unbalanced: 30 Ohm
SYSTEM SPECIFICATIONS	Bandwidth	20Hz to 20kHz, +0/-0.5dB
	Frequency Response	0.35Hz to 200kHz, +0/-3dB
	Noise	>95dBu, unweighted, 22Hz to 22kHz
	THD	0.008% typ. @+4dBu, 1kHz, Gain 1 0.04% typ. @+20dBu, 1kHz, Gain 1
	IMD	0.01% typ. SMPTE
	Crosstalk	<-100dB, 22Hz to 22 kHz
BASS PROCESSOR	Type	"Dual Mode" bass processor
	Low Mix	Variable: from 0 to 6
MULTI-BAND PROCESSOR	Type	"Natural Sonic" processor with VSP (Variable Sound Processing)
	NR Sensitivity	Variable: from 0 to 6
	Tune	Variable: from 1 to 8 kHz
	Process	Variable: from Enhancer to Exciter
	High Mix	Variable: from 0 to 6
SURROUND SECTION	Surround	Variable: from 0 to 6
FUNCTION SWITCHES AND CONTROLS	Shift	Switches the frequency of the bass processor between "low" and "ultra-low"
	Mode	Switches the bass sound from "soft" to "tight"
	Auto NR	Activates the noise reduction system
	In/Out	Activates the relay controlled hard-bypass
	Solo	Monitors the pure effect signal (solo function)
	Surround	Activates the surround processor
INDICATORS	Effect	13 LED meter indicates the effect
	Function switch	LED indicator for each function switch
POWER SUPPLY	Mains voltage	USA/Canada 120V~, 60Hz
		U.K./Australia 240V~, 50Hz
		Europe 230V~, 50Hz
		General export model 100-120V~, 200-240V~, 50-60Hz
	Fuse	95-120V~: T 500mAL
		210-240V~: T 315mAL
	Power consumption	Max. 16 Watts
Mains connection	Standard IEC receptacle	
PHYSICAL	Dimensions (H x W x D)	1 3/4" (44.5mm) x 19" (482.6mm) x 8 1/2" (217mm)
	Net Weight	Approx.2.2kg
	Shipping Weight	Approx.3.4kg

7. BLOCK DIAGRAM

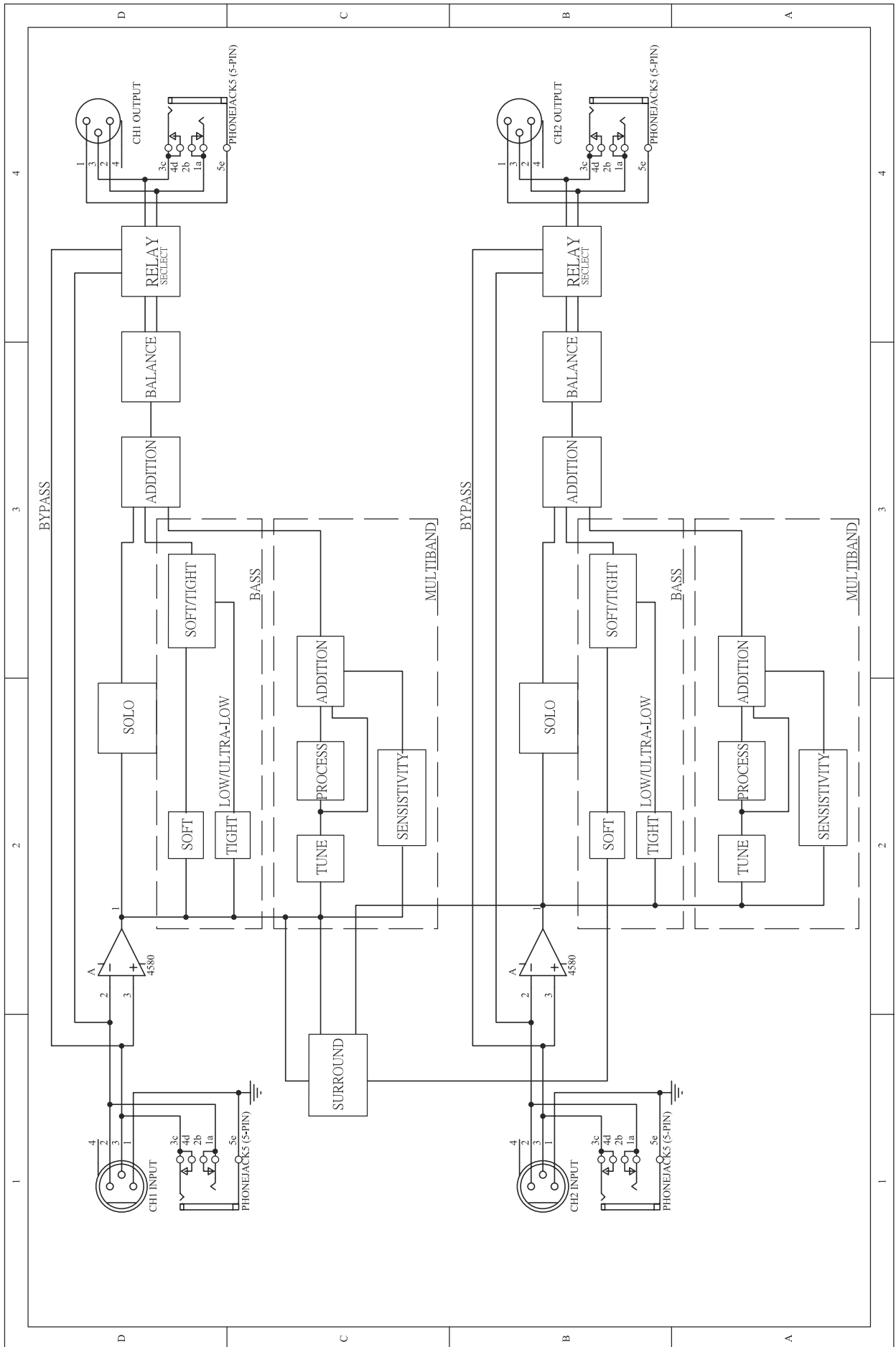

8. WARRANTY

1. WARRANTY REGISTRATION CARD

To obtain Warranty Service, the buyer should first fill out and return the enclosed Warranty Registration Card within 10 days of the Purchase Date.

All the information presented in this Warranty Registration Card gives the manufacturer a better understanding of the sales status, so as to purport a more effective and efficient after-sales warranty service.

Please fill out all the information carefully and genuinely, miswriting or absence of this card will void your warranty service.

2. RETURN NOTICE

2.1 In case of return for any warranty service, please make sure that the product is well packed in its original shipping carton, and it can protect your unit from any other extra damage.

2.2 Please provide a copy of your sales receipt or other proof of purchase with the returned machine, and give detail information about your return address and contact telephone number.

2.3 A brief description of the defect will be appreciated.

2.4 Please prepay all the costs involved in the return shipping, handling and insurance.

3. TERMS AND CONDITIONS

3.1 ▲LTO warrants that this product will be free from any defects in materials and/or workmanship for a period of 1 year from the purchase date if you have completed the Warranty Registration Card in time.

3.2 The warranty service is only available to the original consumer, who purchased this product directly from the retail dealer, and it can not be transferred.

3.3 During the warranty service, ▲LTO may repair or replace this product at its own option at no charge to you for parts or for labor in accordance with the right side of this limited warranty.

3.4 This warranty does not apply to the damages to this product that occurred as the following conditions:

- Instead of operating in accordance with the user's manual thoroughly, any abuse or misuse of this product.
- Normal tear and wear.
- The product has been altered or modified in any way.
- Damage which may have been caused either directly or indirectly by another product / force / etc.
- Abnormal service or repairing by anyone other than the qualified personnel or technician.

And in such cases, all the expenses will be charged to the buyer.

3.5 In no event shall ▲LTO be liable for any incidental or consequential damages. Some states do not allow the exclusion or limitation of incidental or consequential damages, so the above exclusion or limitation may not apply to you.

3.6 This warranty gives you the specific rights, and these rights are compatible with the state laws, you may also have other statutory rights that may vary from state to state.

SEIKAKU TECHNICAL GROUP LIMITED
No. 1, Lane 17, Sec. 2, Han Shi West Road, Taichung 40151, Taiwan
<http://www.altoproaudio.com> Tel: 886-4-22313737
email: alto@altoproaudio.com Fax: 886-4-22346757

All rights reserved to ALTO. All features and content might be changed without prior notice. Any photocopy, translation, or reproduction of part of this manual without written permission is forbidden. Copyright © 2005 SEIKAKU GROUP