

Spark 2

User Manual



Table of Contents

03	Product Spec
05	Hardware Control (Top)
07	Hardware Control (Rear)
08	Pairing Spark 2 and the Spark App
08	To play music via Bluetooth®
09	USB Audio
10	Installing Battery
11	Pairing With Spark Control X
12	Tuner Mode
13	Factory Default Settings
14	Factory Reset / Force Shutdown & Restart
16	App Connection
17	Log In to Your Positive Grid Account
18	Manage Your Profile
19	Adjusting Effects and Presets
20	Exploring ToneCloud®
20	Search and Preset Actions
21	Share Your Own Presets to ToneCloud
22	Explore Other's Profiles
23	Looper: Simple Looper
24	Adjusting Time Settings
25	Start Recording
26	Dub, Undo/Redo
27	Discard a Loop, Mixer
28	Looper: Groove Looper
29	Adjusting Time Settings
30	Adding Drums
31	Start Recording
32	Dub, Undo/Redo
33	Discard a Loop, Mixer

Table of Contents

- 34** Using Spark AI
- 35** Using Smart Jam
- 36** Playing With Dave/Sharon/Charles
- 38** Playing With Jarvis
- 39** Saving a Backing Track
- 40** Starting a Quick Jam
- 41** Using Auto Chords and Tones
- 42** Connecting Apple Music
- 43** Recording Video
- 44** Using Voice Command
- 45** Device Card and Adjustments (Bluetooth Settings, Power Settings and more)
- 46** Updating the Firmware on Spark 2
- 47** Other Available Functions
- 47** Tuner and Metronome
- 48** Back Up Presets to Drop Box
- 49** Online Support

Product Specification

AUDIO SPECIFICATIONS

FREQUENCY RANGE

20-20000 Hz

STEREO/MONO

STEREO

MAXIMUM SOUND PRESSURE LEVEL

RMS : 114 dB SPL @ 1m

Peak : 120 dB SPL @ 1m

CABINET PRINCIPLE

Bass Reflex

POWER AMPLIFIERS

50W RMS, Class D Amplifier

SPEAKERS

2 x 4 inch Full Range Speaker with Custom Angled Horn

TOTAL IMPEDANCE

4 ohms

ONBOARD LOOPER

Up to 60 seconds recording time

POWER

MAIN INPUT POWER

DC 20V, 3.25A

BATTERY TYPE (Spark Battery)

Detachable 6,000 mAh rechargeable lithium-ion battery

(Spark Battery sold separately.)

CHARGING TIME

3 hours

PLAY TIME

Up To 12 Hours (on mid volume)

CONTROLS AND CONNECTIVITY

FRONT PANEL CONTROLS

Power Button

Eight Programmable Preset Selector

Amp Controls (Gain, Bass, Mid, Treble, Master Mod, Delay, Reverb, Volume)

Bluetooth/Music Channel Volume

Looper Controls (Rec/Dub, Play/Stop, Undo/Redo/Clear)

Tap/Tuner Button

REAR PANEL CONTROLS

Bluetooth Pair Button

COMPUTATIONAL AUDIO

Sonic IQ Computational Audio

Dedicated Computational Audio Chip

Dynamic Range Compression

Bass Enhancement

Stereo Widening

Auto EQ

ONBOARD EFFECTS

33 Amp Models (For electric guitar, acoustic guitar, bass)

43 Effects (Noise Gate, Compressor, Distortion, Modulation/EQ, Delay, Reverb)

Choose up to 3 pre-amp effects, 3 post amp effects, and 1 amp model for each preset

WIRED CONNECTIVITY

1/4" Instrument Input x 1

1/8" Headphone Output x 1

1/4" Line Output x 2 (L/Mono & R)

WIRELESS CONNECTIVITY

Bluetooth 5.0

USB AUDIO

USB Interface for Recording, compatible with MacOS and Windows

1 In x 2 Out

24 Bit, 44.1 kHz Sample Rate

Product Specification

PHYSICAL UNIT

DIMENSIONS

Spark 2:

L 375 x W 180 x H 214 mm

(L 14.76 x W 7.09 x H 8.43 inch)

Spark Battery (sold separately):

L 86 x W 74 x H 48.7 mm

(L3.38 x W2.91 x H1.91 inch)

WEIGHT

Spark 2:

5.5 kg / 12.125 lb

Spark Battery (sold separately):

480g / 1.05 lb

GRILLE CLOTH

Custom Black/Gold

SOFTWARE

MOBILE APPS

Spark App for iOS and Android (included)

Spark App Core Features

Smart Jam - 4 Drummers Included

Auto Chords

100,000+ Tones On ToneCloud®

Spark AI

Simple & Groove Looper

Video Recording

Tuner

INCLUDED IN THE BOX

BOX CONTENTS

Spark 2 Amplifier

USB C to C Cable

AC to DC Power Adapter

Get Started Card

Safety Instructions Card

Front Panel

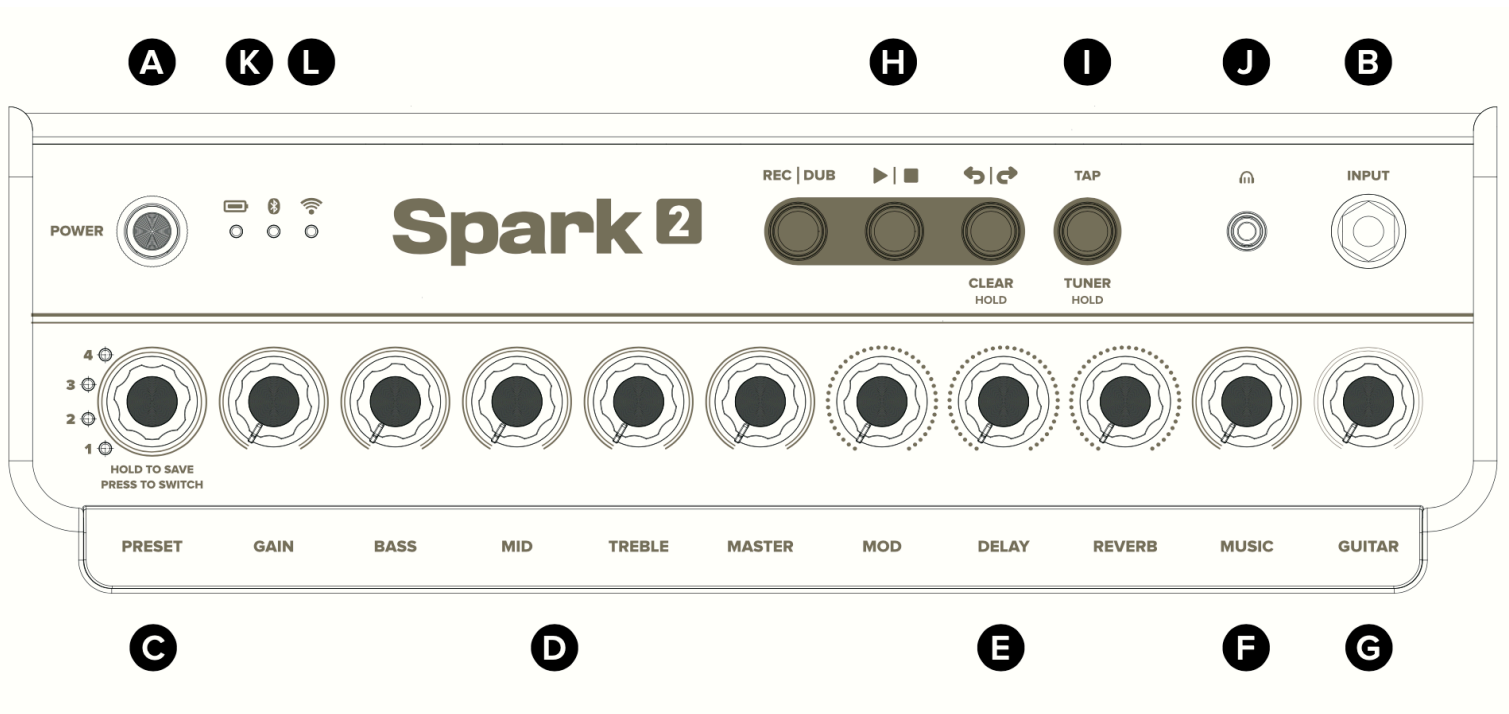

Front Panel

A - Power Switch

Hold to turn on/off Spark 2.

B - Instrument Input (1/4")

For general electric guitars, acoustic guitars or basses.

C - Preset Selector

Turn the knob to switch between the 8 customizable presets.
Press the knob to swap between the 4 red and 4 green preset banks.

D - Amp Control

Controls the gain, EQ and master of the amp model in the current preset.

E - Effect Control

Controls the MOD/DELAY/REVERB effect levels in the current preset.

F - Music Volume Control

Controls the volume of Bluetooth music playback, USB audio and the looper click.

G - Guitar Volume Control

Controls the overall volume of your guitar.

H - Looper Control (more options available in the Spark app, [see p.23](#))

REC/DUB: Tap to start recording or overdubbing. Tap again to stop recording and start playback.

PLAY/STOP: Starts/stops the loop playback. Hold to switch between Auto Mode and Signal Detection Mode for standalone recording:

- Auto Mode (Click On): Adjustable loop length. It will automatically start recording after a 1 bar count-in and stop recording when reaching the length set in the Time Settings menu in the Spark app. It's the default recording mode.
- Signal Detection Mode (Click Off): Free length. It will automatically start recording when Spark 2 detects a guitar signal, users tap on the record button to stop recording. The REC/DUB LED will show yellow when switching to Signal Detection Mode.

UNDO/REDO (CLEAR): Removes/restores the last layer added to the loop. Hold to completely erase the recorded loop.

I - Tap/Tuner

Tap to set the tempo of delay effects and the looper. Hold to enter Tuner mode.

J - Headphone Output (1/8")

Plug in a pair of headphones with a 1/8" jack.

K - Battery Indicator

Indicates battery status. With Battery loaded:

Solid Green: Battery level 50-100%

Solid Yellow: Battery level 10-50%

Solid Red: Battery level under 10%

Flashing Green/Yellow/Red: Charging

L - Wireless Indicators

Indicates the status of Bluetooth and Wi-Fi connections.

Solid Blue/Green: Connected

Flashing Blue/Green: Pairing

Rear Panel

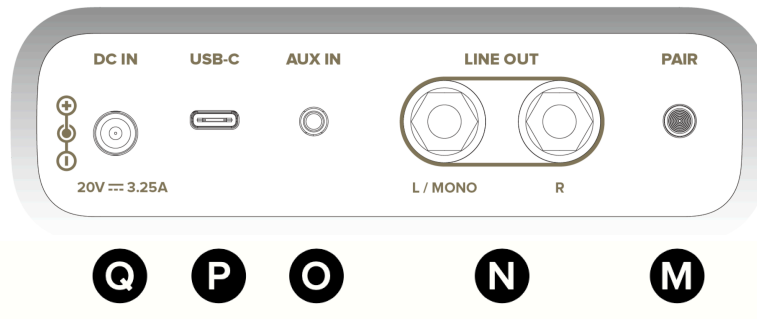

M - Pair Button

Press to enter Bluetooth® pairing mode when connecting to a new device.
Hold to enter pairing mode when connecting to Spark Control X.

N - Line Output (1/4")

Connect to the input of an external device, such as a PA system, audio interface, etc.
Use the L/Mono output if only using 1 output.

*Line Output can be configured via the Spark app to mute or unmute the built-in speakers when a cable is connected. See [page 45](#).

O - Aux Input (1/8")

Connect to the stereo 1/8" output of an external device.

P - USB Audio Port (USB-C®)

Connect the supplied USB-C® to USB-C® cable to a PC/Mac to use as an audio interface.

Q - DC Power Input

Connect with the supplied Power Adapter to a power outlet.

Pairing Spark 2 and the Spark App

- Download the Spark app using the QR code provided or search 'Spark amp' in the App Store or Google Play Store.
- Turn on Spark 2 by holding the Power button.
- Open the Spark app on your mobile device and follow the instructions to connect your Spark to access all of the gear, smart features, and more.

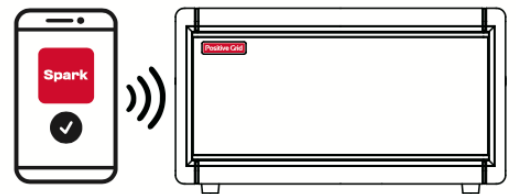
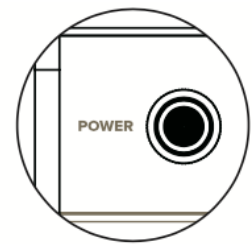

Connecting Bluetooth® to Play Music

- To pair a new device, press the Pair button on the Rear Panel of Spark 2, turn Bluetooth® on in the settings of your mobile device, and select "Spark 2 Audio" from the list of scanned devices.
- Spark 2 will automatically pair with the last device it connected to. If the last device is not available, Spark 2 will automatically connect to a device that has been previously paired.



Connecting USB Audio

1. With Spark 2 turned off, connect to a computer via USB with the included USB cable.
2. Turn on Spark 2 and select “Spark 2 USB Audio” as the recording/playback device.
3. Adjust USB playback volume with the Music Volume buttons on Spark 2.
4. Adjust direct guitar monitoring with the Guitar Volume knob.
5. ASIO driver is required for Windows users. A download link is available on the Spark 2 support page.

Installing Spark Battery

Spark 2 is only compatible with Spark Battery (sold separately). Spark 2 will use Spark Battery power when unplugged. Spark Battery features up to 12 hours of play time and automatically starts charging when Spark 2 is plugged into a power outlet.

*Please be aware that using a third party battery can damage your Spark 2.

- Make sure Spark 2 is off and unplug the power cord.
- Open the battery cover on the bottom and lift it up

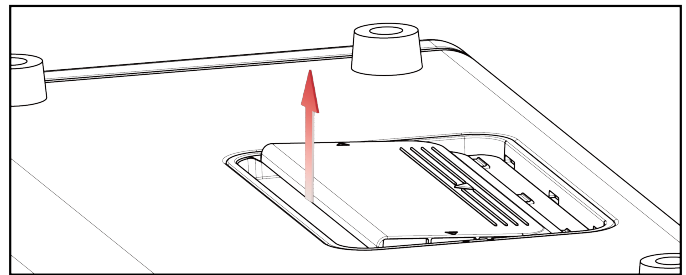
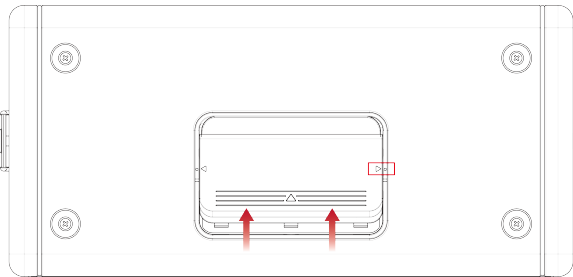

- Insert Spark Battery with the sticker facing the front grille.

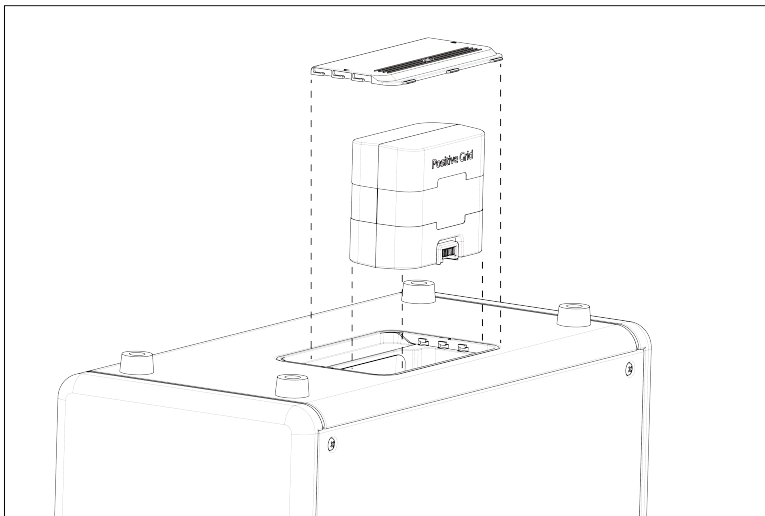

- Put back the cover.

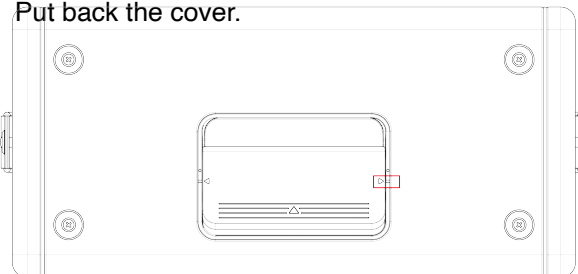

- You can now turn on Spark 2 using battery power.

Pairing Spark Control X

- **Step1.** Turn on Spark 2 and Spark Control X

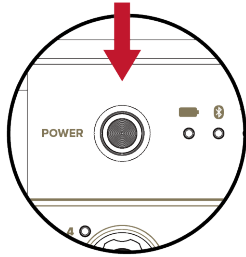

- **Step2.** Long press the Pair button on the Rear Panel of Spark 2 until both Wireless Indicator LEDs on the Front Panel light up.

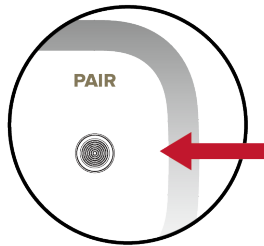

- **Step3.** Spark 2 will automatically connect to Spark Control X.

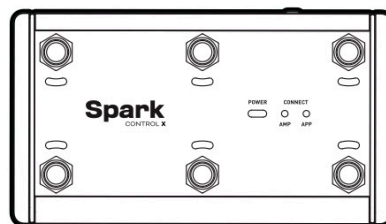
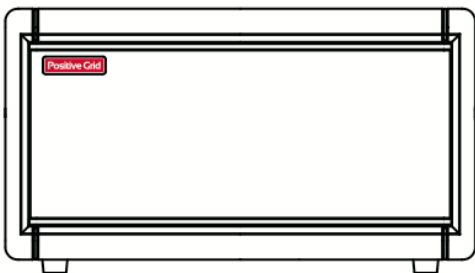

Tuner Mode

- Hold the TAP/TUNER button to enter tuner mode.
- While in Tuner Mode, the 3 Looper LEDs will display if the string being played is in tune.
- Note that the output of Spark 2 will be muted while Tuner Mode is on.
- To exit Tuner Mode, press the TAP/TUNER button again.

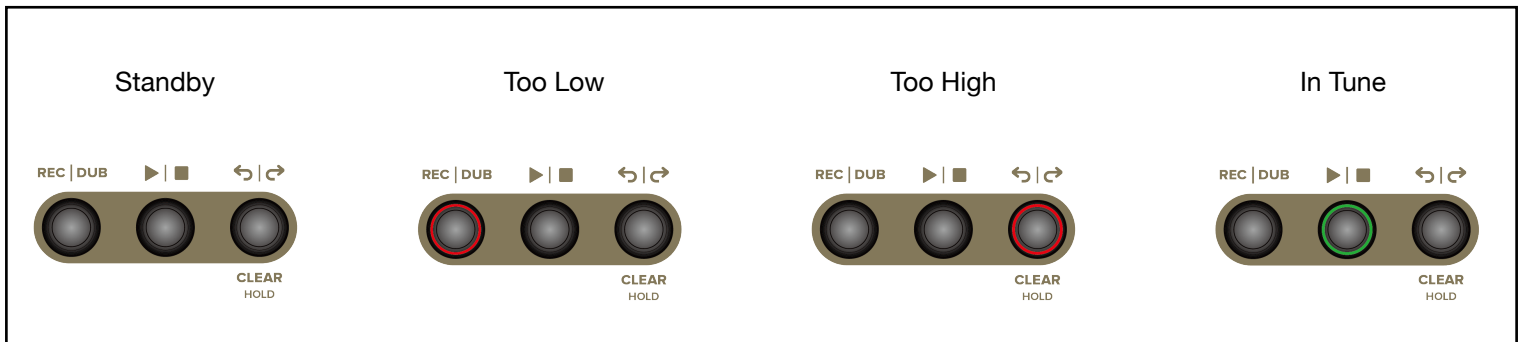

Factory Default Settings

Default Built-in Presets

CH1

- Red Preset 1 : Rhythm Guitar Style Tone 1
- Red Preset 2 : Lead Guitar Style Tone 1
- Red Preset 3 : Solo Guitar Style Tone 1
- Red Preset 4 : Ambient Guitar Style Tone 1
- Green Preset 1 : Rhythm Guitar Style Tone 2
- Green Preset 2 : Lead Guitar Style Tone 2
- Green Preset 3 : Solo Guitar Style Tone 2
- Green Preset 4 : Ambient Guitar Style Tone 2

More presets can be downloaded and customized for free on ToneCloud. You can access ToneCloud via the Spark app, search for a custom preset, download it for free, and then save the preset directly to Spark 2 by tapping 'Save to hardware preset' in the menu.

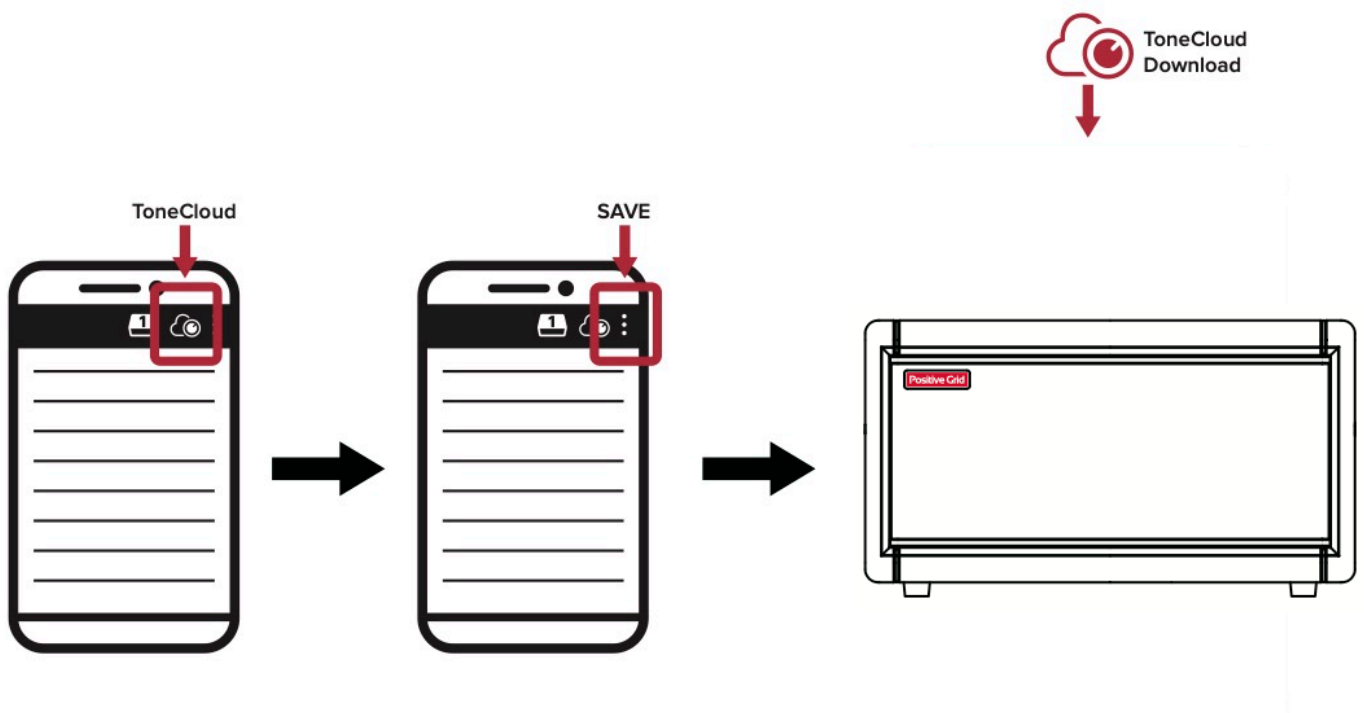

Factory Reset

Follow the steps below to perform a factory reset. This process will reset all the presets stored on Spark 2 as well as Bluetooth and power saving settings.

1. Turn off your Spark 2.
2. Hold the Power Button and Preset Knob at the same time and then release the buttons when the Battery Indicator turns white.
3. Hold the Power Button, until all four preset LEDs blink, then release.
4. Spark 2 will turn off automatically and will return to its factory settings when powered back on.

*You may cancel the factory reset up until step 2 by tapping the Power Button.

Force Shutdown & Restart

If Spark 2 becomes unresponsive, freezes, or emits unusual noises, follow these steps to force a shutdown and restart:

1. Hold the Power button for over 10 seconds.
2. Release the Power button, then press and hold it again to turn Spark 2 back on.

Spark App

User Guide



DOWNLOAD THE SPARK APP

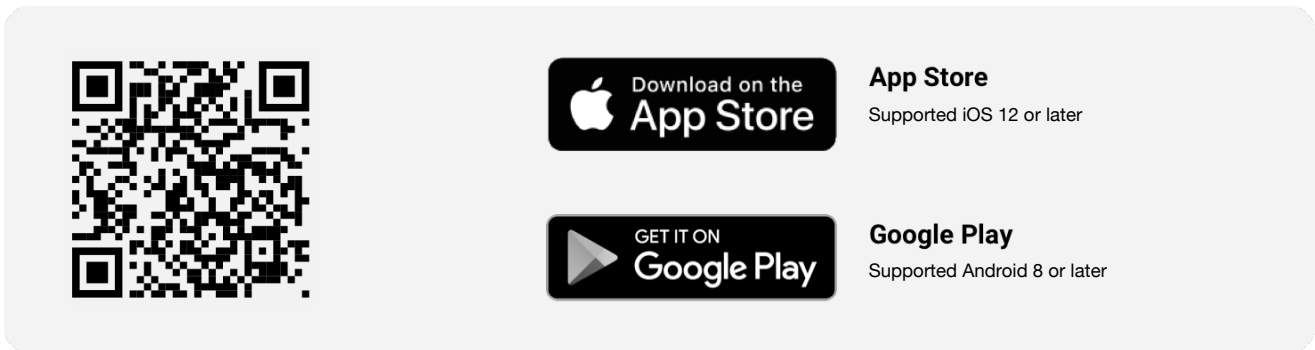

Download and install the Spark App compatible with your smartphone's operating system.

Connecting Spark to Your Mobile Device

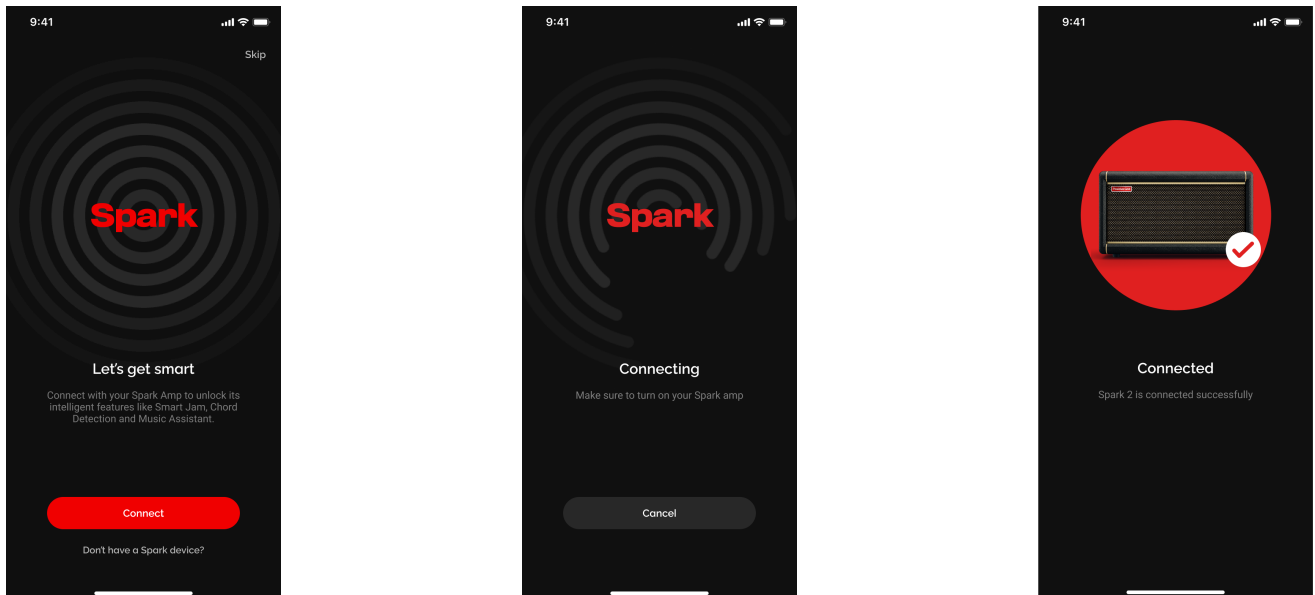

(A) Make sure to allow the Spark app access to Bluetooth (iOS) or Location Services (Android) to allow the Spark app to establish a Bluetooth connection with your Spark.

(B) Turn on your Spark amp.

(C) Open the Spark app.

(D) Tap Connect and the Spark app will search and connect to your Spark.

Tip: Connect Spark to your mobile device as a Bluetooth speaker to play music via your mobile device's Bluetooth settings. A stable connection between the amp and the app is required for audio output.

Tip: Selecting a device will only occur when you first install the Spark app. Subsequent connections will be done by pressing the connect button when you enter the Spark app.

Tip: If you are unable to connect to the amp, ensure that other nearby Bluetooth devices are turned off and try again.

Log In to Your Positive Grid Account

Log in to your Positive Grid account to download tones from ToneCloud and more.

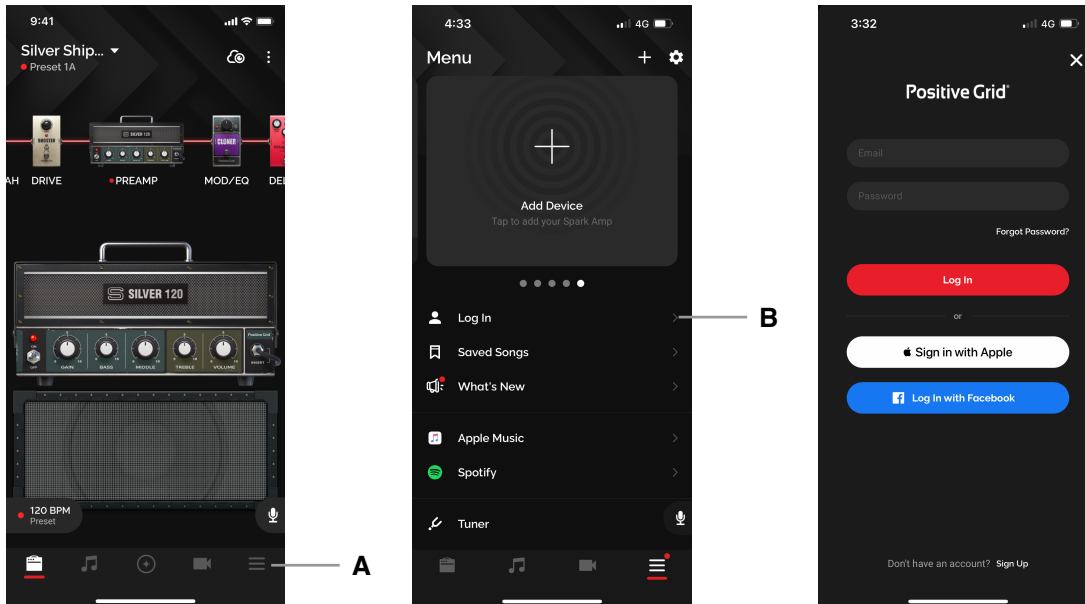

(A) Tap the Menu icon



(B) Tap Log In

(C) Log in with your existing account, use your Apple ID or Facebook ID, or tap on Sign Up to create a new account

Manage Your Profile

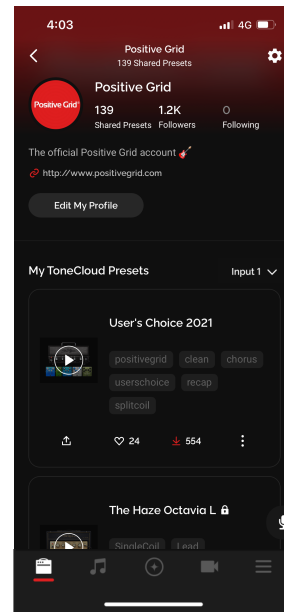
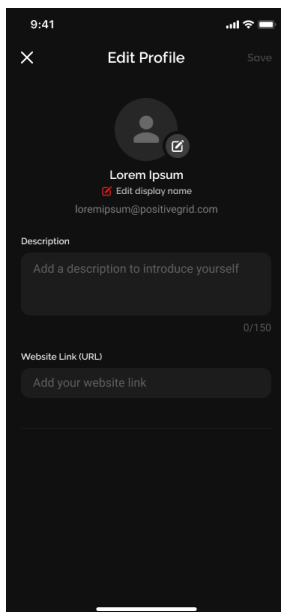
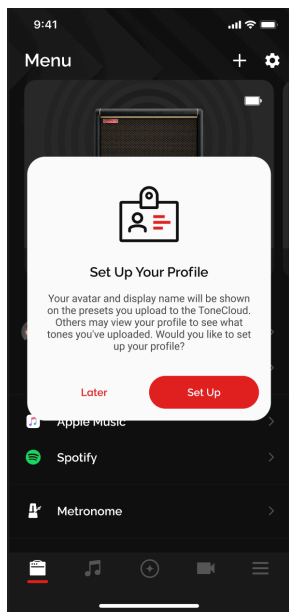
Set up your profile to manage your ToneCloud presets and connect with other Spark users.



- (A) Once you log in, a Set Up Your Profile prompt should appear, which will take you to the Edit Profile Page. You may edit your profile after the fact by going into your profile via the Menu page and tapping on your profile, then tapping on Edit My Profile.
- (B) You may edit your Display Name, which is the name that will be shown to others on ToneCloud, edit your Bio and your URL.
- (C) You may edit your ToneCloud preset details by tapping on the  icon to rename or delete the preset from the ToneCloud.
- (D) You may also log out by tapping the  icon

Note: Deleting your account is permanent and you will not be able to log in with your previously deleted account credentials. Your email will never be publicly shown.

Adjusting Effects and Presets

After connecting your Spark amp to the Spark app, you may tweak settings to your liking or browse our factory presets.

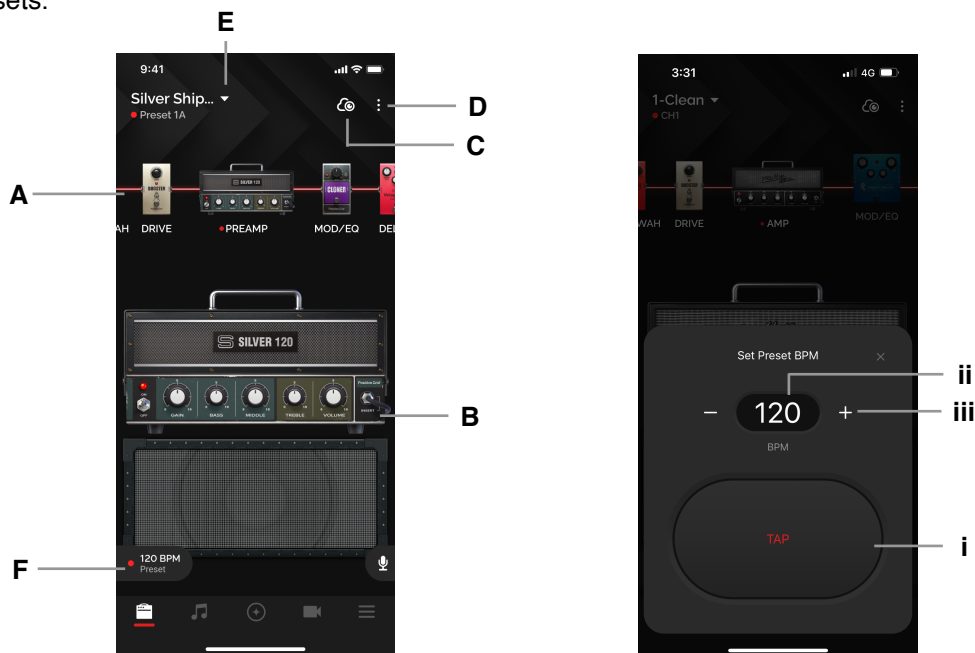

(A) Signal Chain:

1. Swipe left or right to scroll along the signal chain (For mobile)
2. Swipe up and down to switch effects on and off.
3. Double-tap the amp or effects icon to select an effect.

(B) Effects Section:

1. Effects on/off: tap the LED on the amp/effect pedal to switch the effect on and off.
2. Tone control: turn the knobs to adjust the parameters

(C) ToneCloud: tap the top right icon to open ToneCloud.

(D) Option Menu:

1. Overwrite - overwrite the current preset.
2. Save as New - save as a new preset.
3. Share to ToneCloud - share your current preset to ToneCloud.
4. Save to Hardware - save your current preset to a Spark 2 Amp preset slot.

(E) Local Presets - tap the preset name to select presets you've saved to your smartphone
The red dot along with CH1/2/3/4 or RHYTHM/LEAD/SOLO/CUSTOM underneath the Preset name indicates that a preset saved on the Spark amp itself is currently being used.

(F) Tap Tempo - sync up delays and modulations when the BPM sync toggle on the effect is on by assigning a BPM to your preset. You may adjust BPM in 3 ways:

- (i) Tap the TAP button to tap a tempo
- (ii) Tap the BPM value and type in your desired BPM
- (iii) Tap the + or - buttons to adjust by 1 BPM, long press the buttons to jump up by increments of 10 BPM

Exploring ToneCloud®

ToneCloud® is a preset sharing system developed by Positive Grid. Sync your presets across devices, take your tones on the road, share your presets or download presets designed by other musicians in our community from all over the world!

Search and Preset Actions

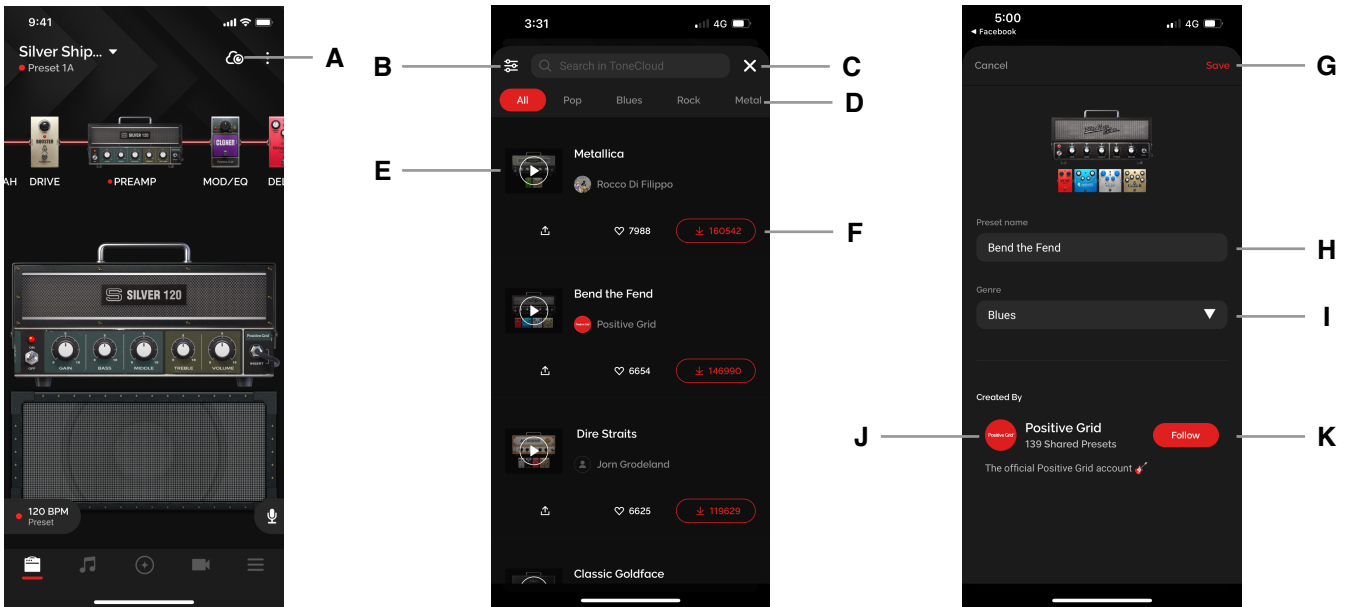

- (A) Tap on the ToneCloud icon to access ToneCloud for the current preset
- (B) Tap to Sort presets
- (C) Tap the X to exit ToneCloud
- (D) Tap on the categories to browse presets by genre
- (E) Tap the Play button on the Preset thumbnail to preview a tone when connected to the Spark amp
- (F) From Left to Right; (i) [ToneLink] Tap on the Share button to share a link to the preset externally, (ii) Tap on the Like button to add the preset to your favorites, (iii) Tap the Download button to bring up the Download menu
- (G) Tap Save to save the preset to your local preset list
- (H) Rename the preset before you save
- (I) Select which category you would like the preset to show up in
- (J) Tap on the Profile to explore the preset creator's profile
- (K) Tap on Follow to follow the creator, their presets will show up in the Following category in ToneCloud

Share Your Own Presets to the ToneCloud

Share presets you've designed yourself for others in the Spark community to enjoy.

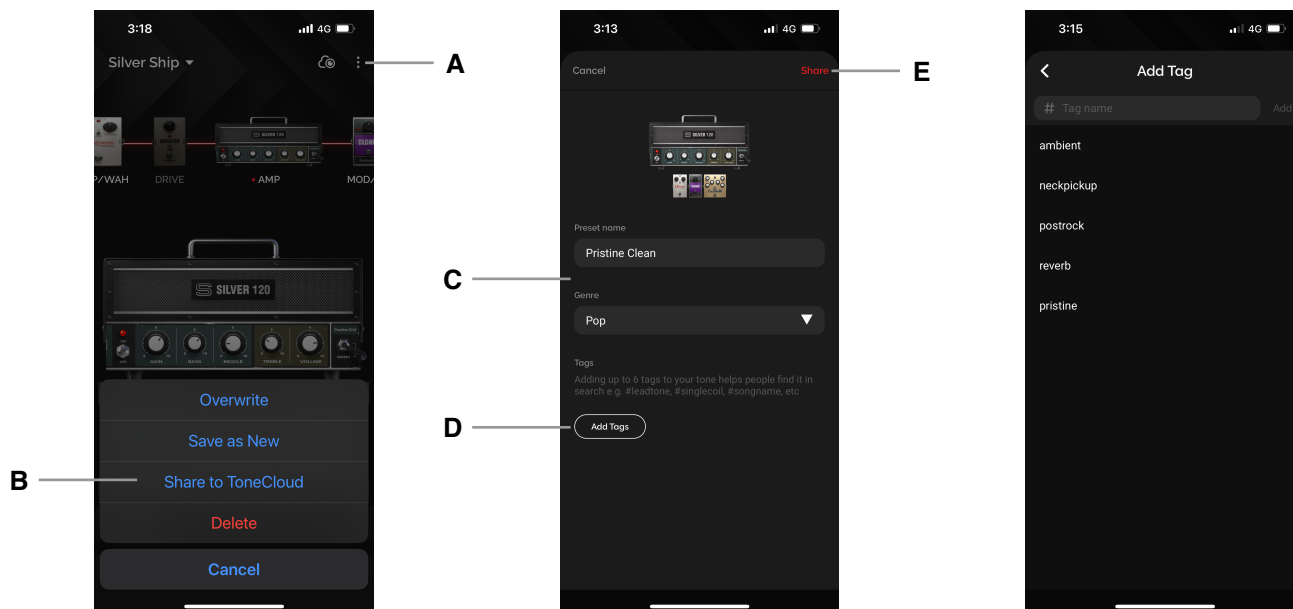

(A) Tap on the  on the top right of the Tone page

(B) Tap Share to ToneCloud

(C) Rename the Preset and select a genre

(D) Add up to 6 tags to make it easier for others to search for your preset; some suggested tags would be pickups used (single coil, humbucker, etc), which pickup position was used, characteristic of the tone (ambient, crunchy, higain, etc) and its usage (lead, rhythm, solo, etc), artist or song, etc.

(E) Tap Share to share it to the ToneCloud

Explore Other's Profiles

Get to know other musicians in the Spark community by exploring and following their profile.

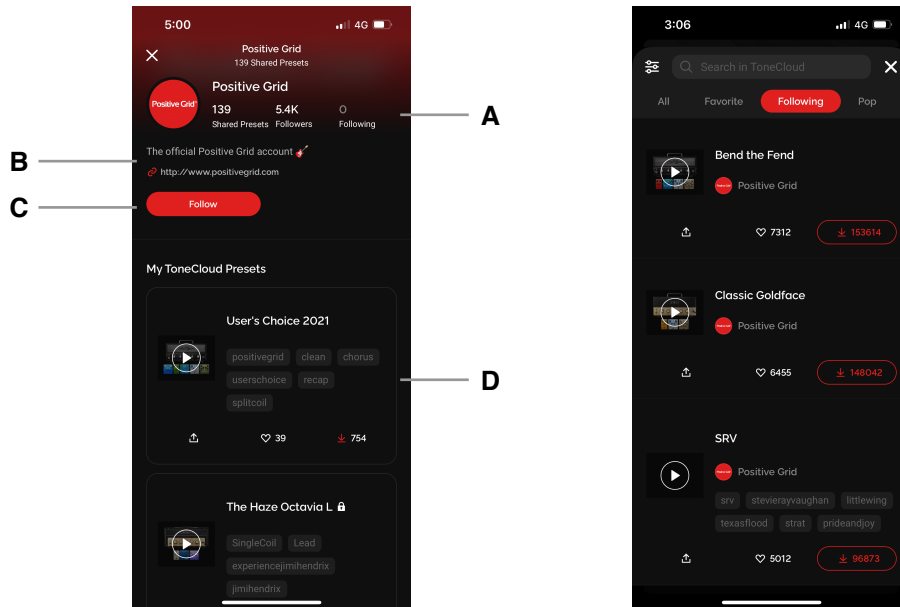

- (A) Tap on Followers or Following to see who the profile owner is following or being followed by.
- (B) Read the profile's Bio or tap on their link to learn more about them.
- (C) Tap on Follow to add them to your follow list; their presets will show up in the Following category of ToneCloud.
- (D) Explore presets that have been shared to ToneCloud by the profile owner.

Looper: Simple Looper

Spark 2 has a built-in looper to further enhance your playing experience. When connected to the app, not only will you get to control the looper via your mobile device, there will be more settings available for you to adjust.

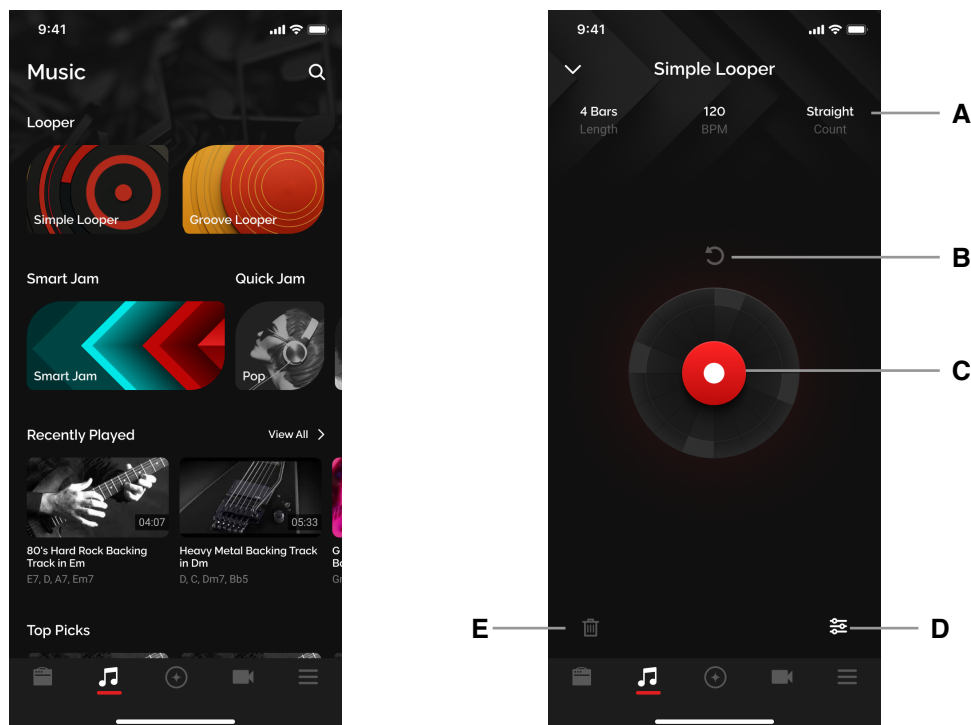

Make sure you are connected to your Spark device's Bluetooth Audio and Tone Control connections, and ensure that your mobile device's volume is also turned up, then tap on the Music page and tap on the Simple Looper banner.

- (A) Looper Settings - tap on this area to access looper settings to adjust parameters.
- (B) Undo/Redo Button - removes or restores last recorded dub layer
- (C) Record/Dub Button, Progress Circle - start recording or dubbing, see how much time is left before the loop repeats
- (D) Mixer Button - Adjust loop and click volume
- (E) Discard Button - discards current loop if present

The looper can record up to 60 seconds, and one loop can be stored on the Spark device at a time.

Simple Looper: Adjusting Time Settings

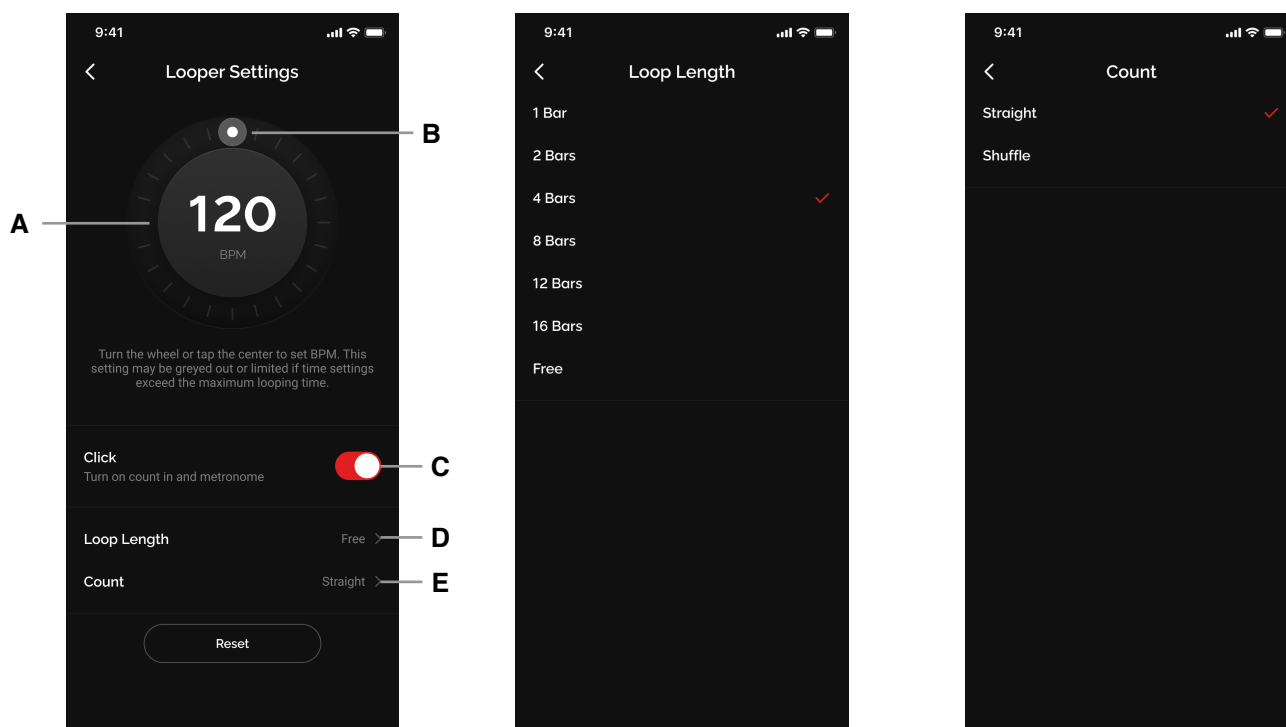

Adjust Time Settings:

1. Tap on the Looper Settings area to enter the menu
2. Adjust BPM
 - (A) Tap on the center 3 times or more for Tap Tempo functionality
 - (B) Tap the edge of the circle and rotate the dial to change tempo
 - I. The BPM setting will always follow the BPM of your current preset; changing your preset before recording will change the BPM to the BPM of the current preset. Once a loop has been recorded, the BPM will not change along with the preset.
 - II. Because the loop limit is 60 seconds, if a BPM and Loop Length setting exceeds this limit, the options will be grayed out e.g.
 1. If the BPM is 40, 12 and 16 bars will not be selectable
 2. If the Loop Length is set to 12, the minimum BPM will be 47 because any lower will exceed 60 seconds
 - III. Minimum BPM is 40, Maximum BPM is 400
- (C) Click toggle
 - I. On - Auto Mode: a metronome will be provided to loop with, and after a 4 beat count in recording will begin. Recording will automatically stop when loop length is reached.
 - II. Off - Signal Detection Mode: recording will start when a guitar signal is detected. You will need to manually tap on the Record button again to stop recording.
- (D) Adjust Loop Length
 - I. Adjust the length of the loop to predetermined lengths
 - II. When "Free" is selected, the loop will stop when you tap on the Record button to stop recording
- (E) Adjust Count
 - I. Select between straight 4/4 feel and shuffle 4/4 feel

Simple Looper: Start Recording

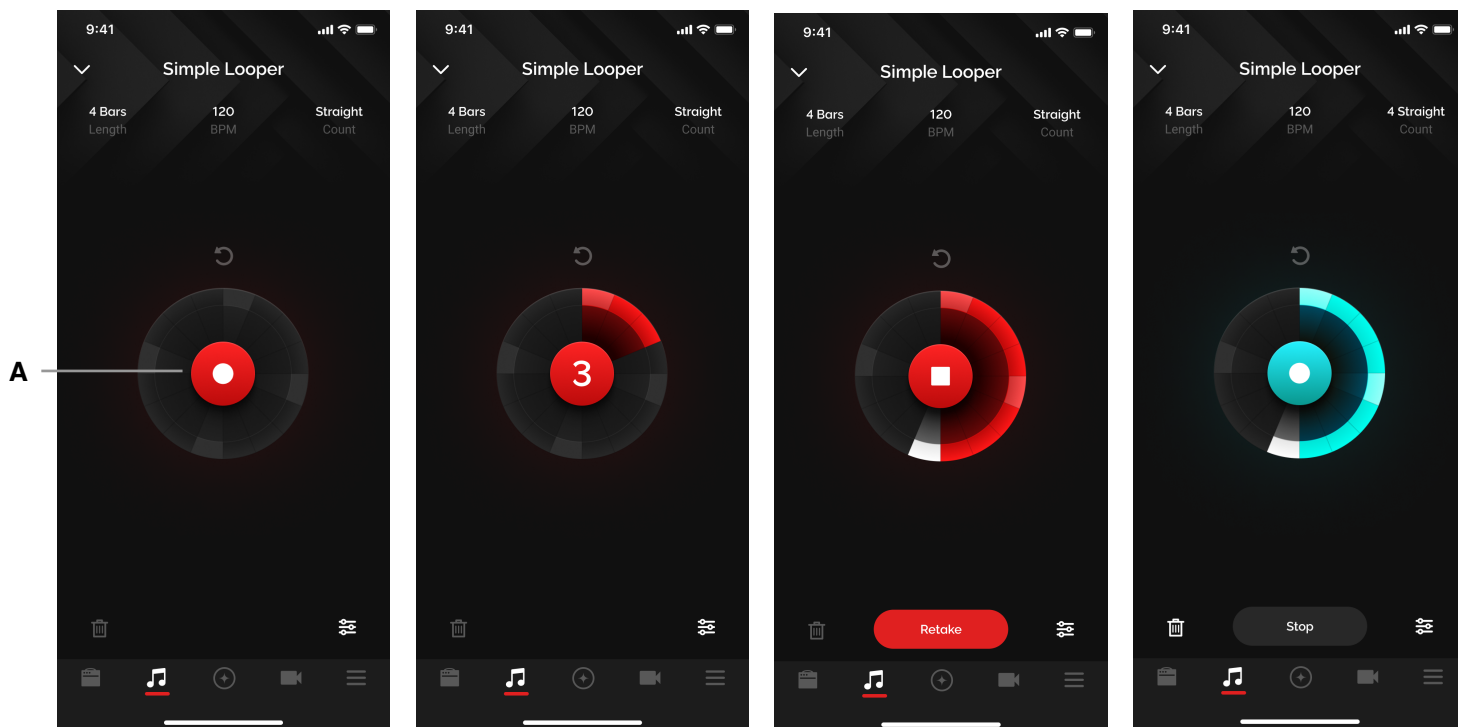

Start Recording

- (A) Tap on the recording button in the middle of the circle
- Depending on your Click and length settings, the recording function exhibits different behavior:
 - Click On (Auto Mode): a four beat count in will begin, after the four beats it will start recording
 - Length Not Free: after the recording reaches the length of the loop length set in looper settings, it will automatically stop recording. If you tap the record button during this step, you will stop the recording, however the length of the loop will be the same depending on the length you set in the looper settings. Playback will begin from the point you pressed stop, so the loop will be empty until it replays the loop.
 - Length is Free: to stop recording, tap on the record button again. Playback will commence immediately from the beginning of the loop.
 - Click Off (Signal Detection Mode): the button will start breathing, and will start recording once a guitar signal is detected. Stop recording by tapping on the record button again
 - If you make a mistake, tap on the Retake button to immediately go back to the count in step to immediately start recording again
 - After a recording is complete, you may not adjust looper settings until you discard the loop.

Simple Looper: Dub, Undo/Redo

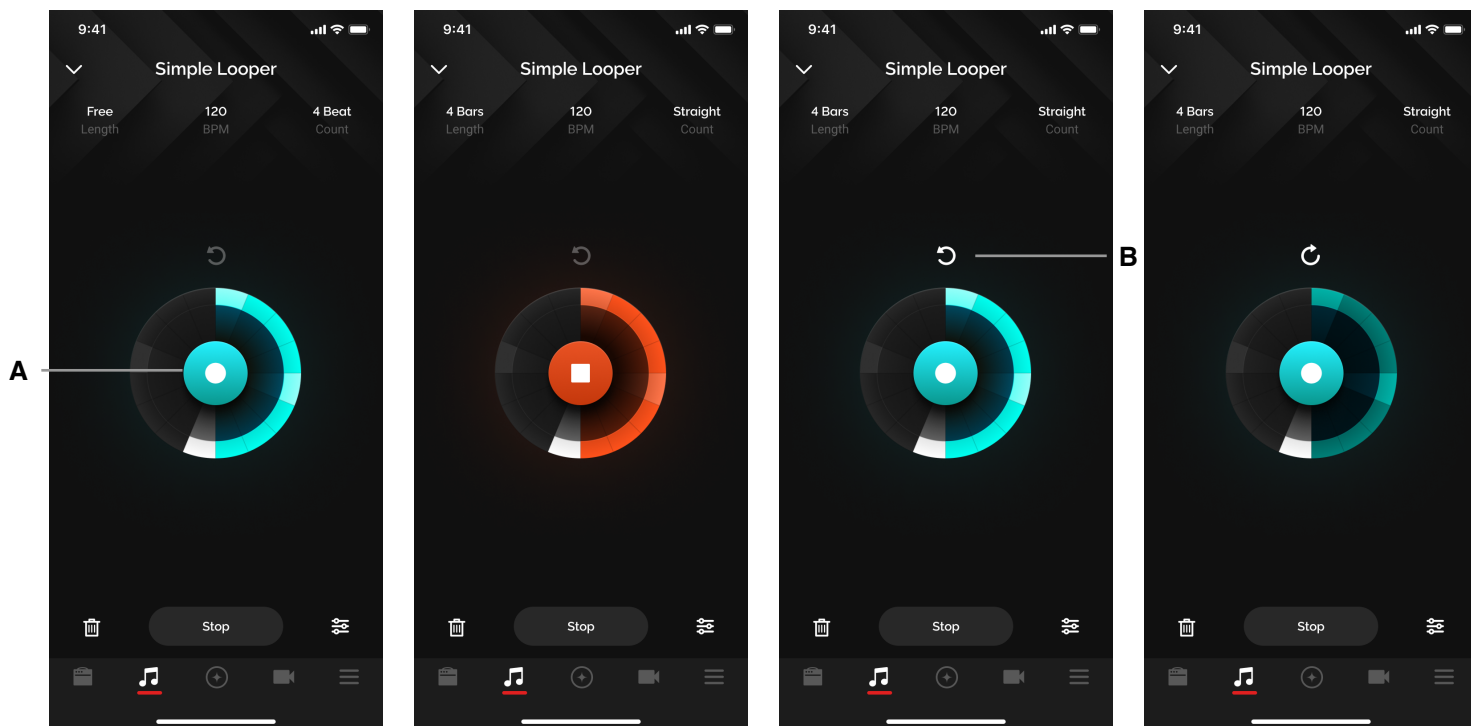

Dub, Undo/Redo

(A) Tap on the center of the circle to begin dubbing

1. There will be no click while dubbing even if Click is on as you may follow your original recording as the foundation to your loop
2. Dub will start from whenever you pressed the dub button.
3. You may dub as many layers as you want
4. The dub can also be as long as you want, it will record over the loop e.g if the base recording is 10 seconds, a dub can be 20 seconds (2 loops of the base recording), meaning you dubbed over two cycles of the loop.

(B) Undo/Redo functionality:

1. Tapping on undo will remove the last recorded layer. The button will switch to Redo
2. Tapping on redo will restore the layer. The button will switch to Undo
3. If there are no dubs present, undo and redo functionality will be disabled
4. When undo is triggered and the last recorded layer is removed, and a dub is triggered, once the user presses stop dubbing, the previously removed layer will be discarded forever and may not be restored via the redo button. The button will become the undo button once a dub is finished recording.

Simple Looper: Discard a Loop, Mixer

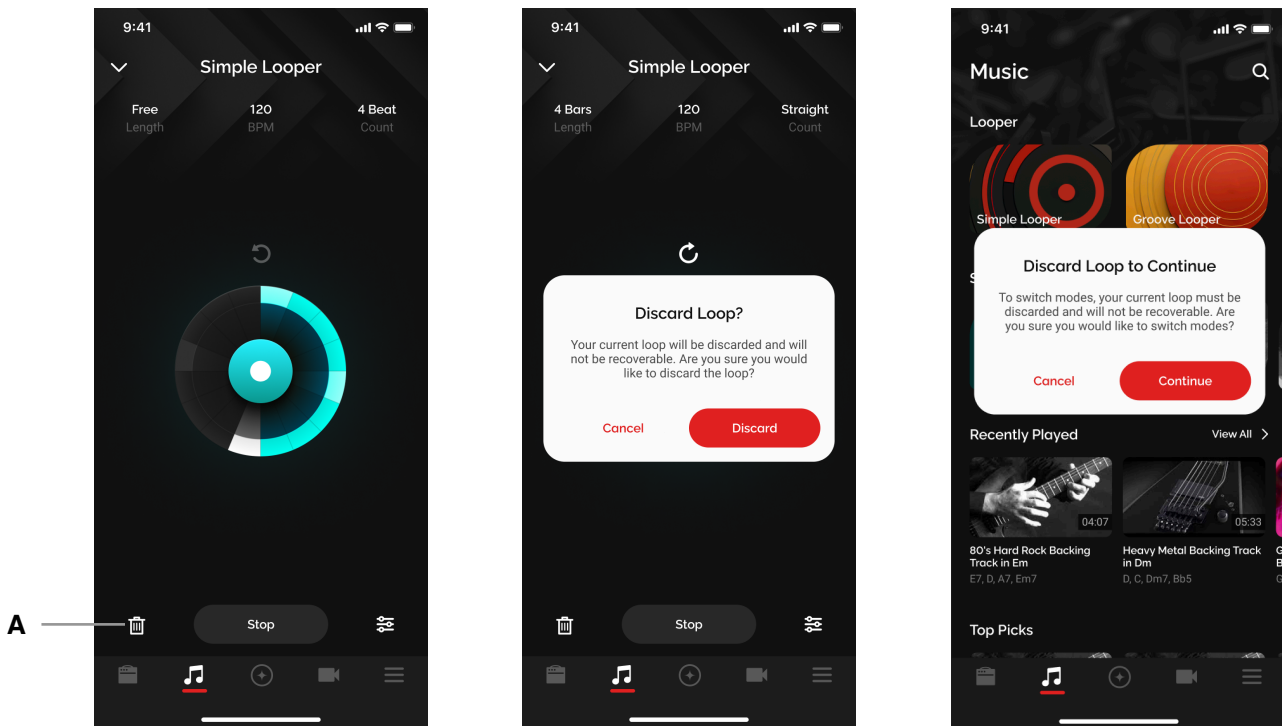

Discarding a loop

- (A) Tap on the Discard icon on the bottom left to discard a loop. A dialog box will appear to confirm your action.
1. When switching between the Simple and Groove Looper, the loop must also be discarded.
 2. If you do not discard a loop, the loop will be stored on the Spark 2 hardware indefinitely until either you discard the loop or perform a factory reset.

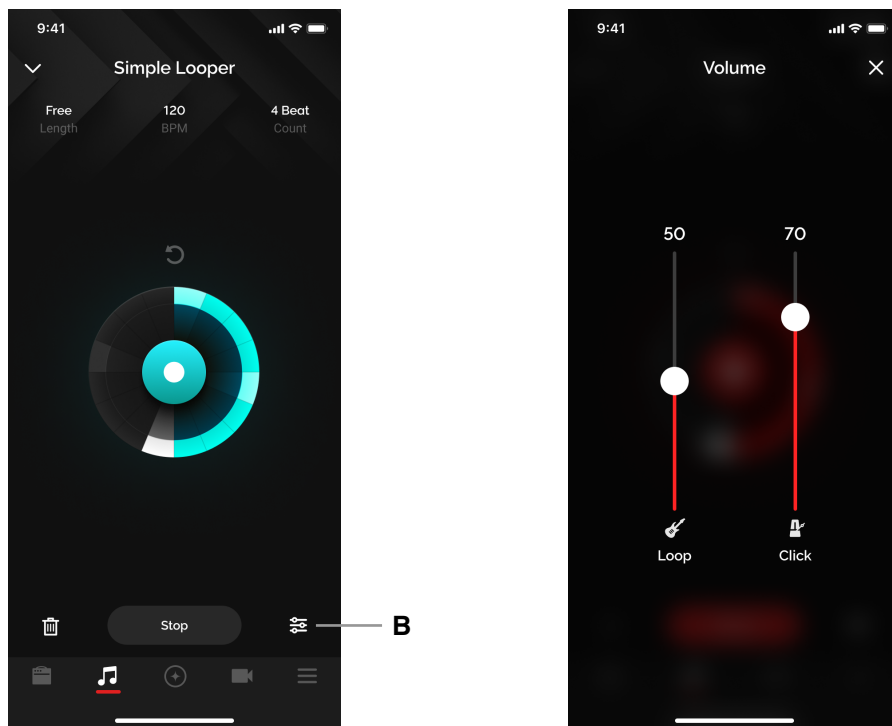

Mixer

- (B) Tap on the Mixer icon on to access the mixer, where you can adjust the loop and click volume
- Tip:** Click volume is also dependent on you mobile device's volume setting. Turn it up and adjust accordingly.

Looper: Groove Looper

The Groove Looper expands on the looper function even further, with realistic drums to accompany your loops to further immerse you in your own music.

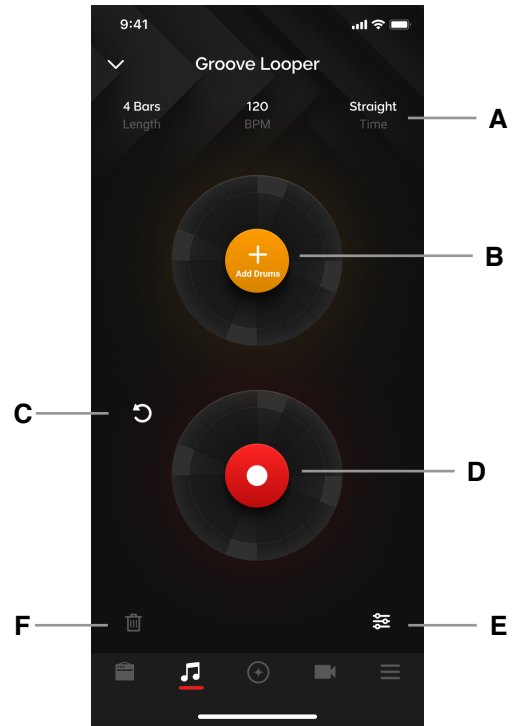
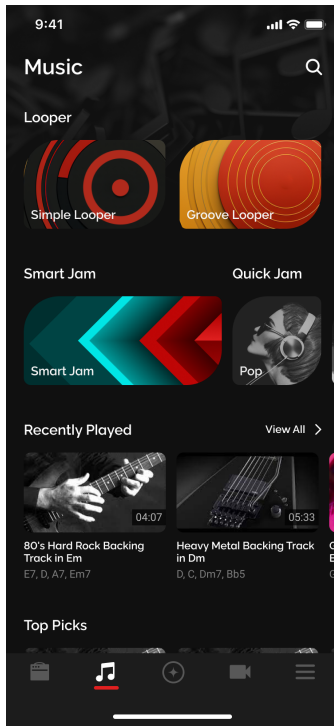

Make sure you are connected to your Spark device's Bluetooth Audio and Tone Control connections, and ensure that your mobile device's volume is also turned up, then tap on the Music page and tap on the Groove Looper banner.

- (A) Looper Settings - tap on this area to access looper settings to adjust parameters.
- (B) Drum Selection Menu - add drum patterns to your loop
- (C) Undo/Redo Button - removes or restores last recorded dub layer
- (D) Record/Dub Button - start recording or dubbing
- (E) Mixer Button - Adjust loop and click volume
- (F) Discard Button - discards current loop if present

Groove Looper: Adjusting Time Settings

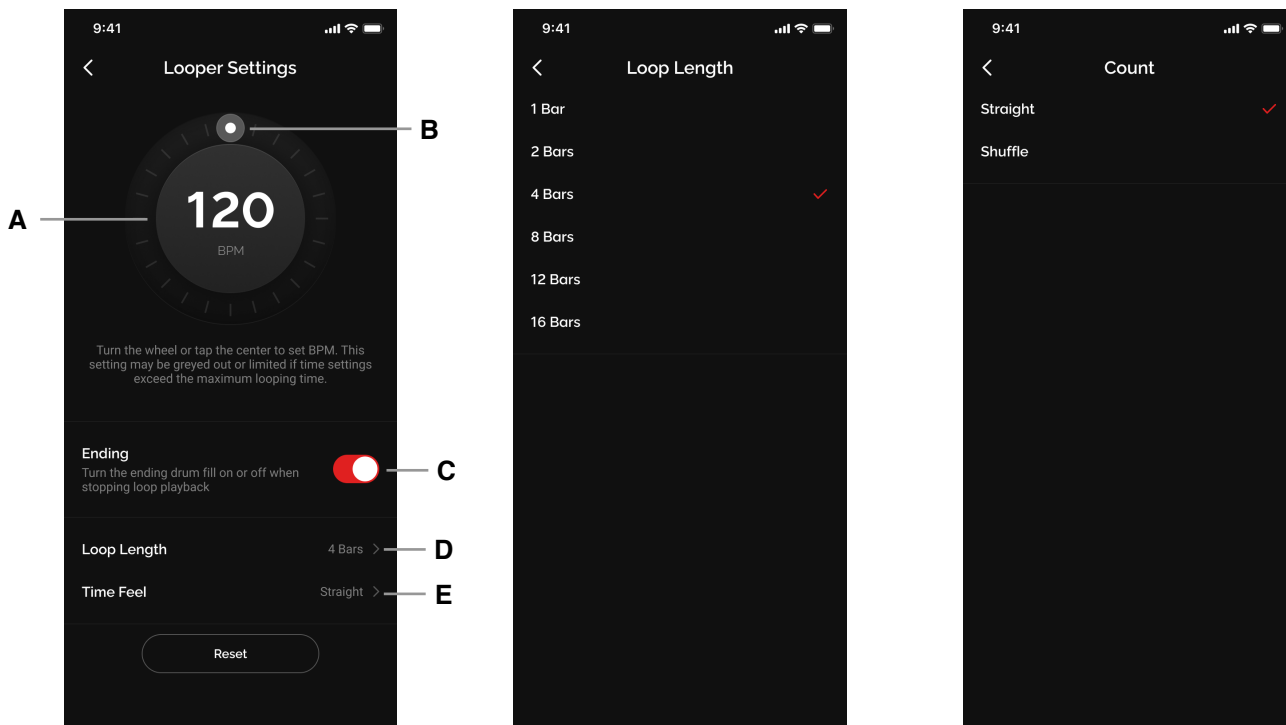

Adjust Time Settings:

1. Tap on the time settings area to enter time settings
2. Adjust BPM
 - (A) Tap on the center 3 times or more for Tap Tempo functionality
 - (B) Tap the edge of the circle and rotate the dial to change tempo
 1. The BPM setting will always follow the BPM of your current preset; changing your preset before recording will change the BPM to the BPM of the current preset. Once a loop has been recorded, the BPM will not change along with the preset.
 2. Because the loop limit is 60 seconds, if a BPM and Loop Length setting exceeds this limit, the options will be grayed out e.g.
 - I. If the BPM is 40, 12 and 16 bars will not be selectable
 - II. If the Loop Length is set to 12, the minimum BPM will be 47 because any lower will exceed 60 seconds
 3. Minimum BPM is 40, Maximum BPM is 400
- (C) Ending Toggle
 1. On: Ending drum fill will play when you stop playback
 2. Off: stops playback immediately
- (D) Adjust Loop Length
 1. Adjust the length of the loop to predetermined lengths
- (E) Adjust Count
 1. Select between straight 4/4 feel and shuffle 4/4 feel
 2. This determines what Drum patterns are available
 - I. Straight feel will have Rock, Funk and Pop available; Blues will not be available to select
 - II. Shuffle feel will have Blues available, Rock, Funk and Pop will not be available to select

Groove Looper: Adding Drums

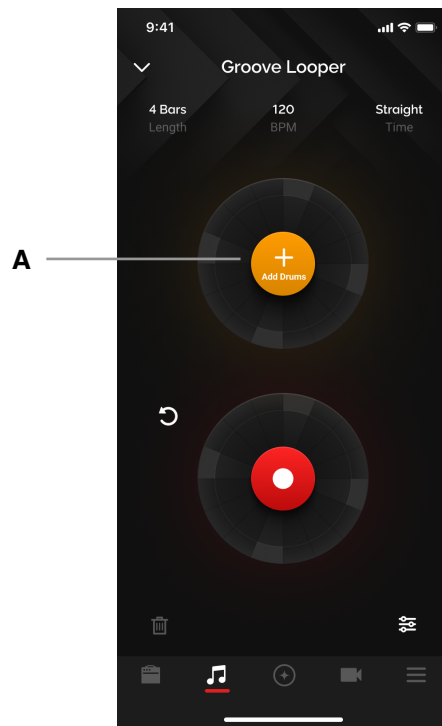

Adding Drums

(A) Tap on the add drum button on the top circle: You may not start recording until you select a drum pattern when in Groove Looper

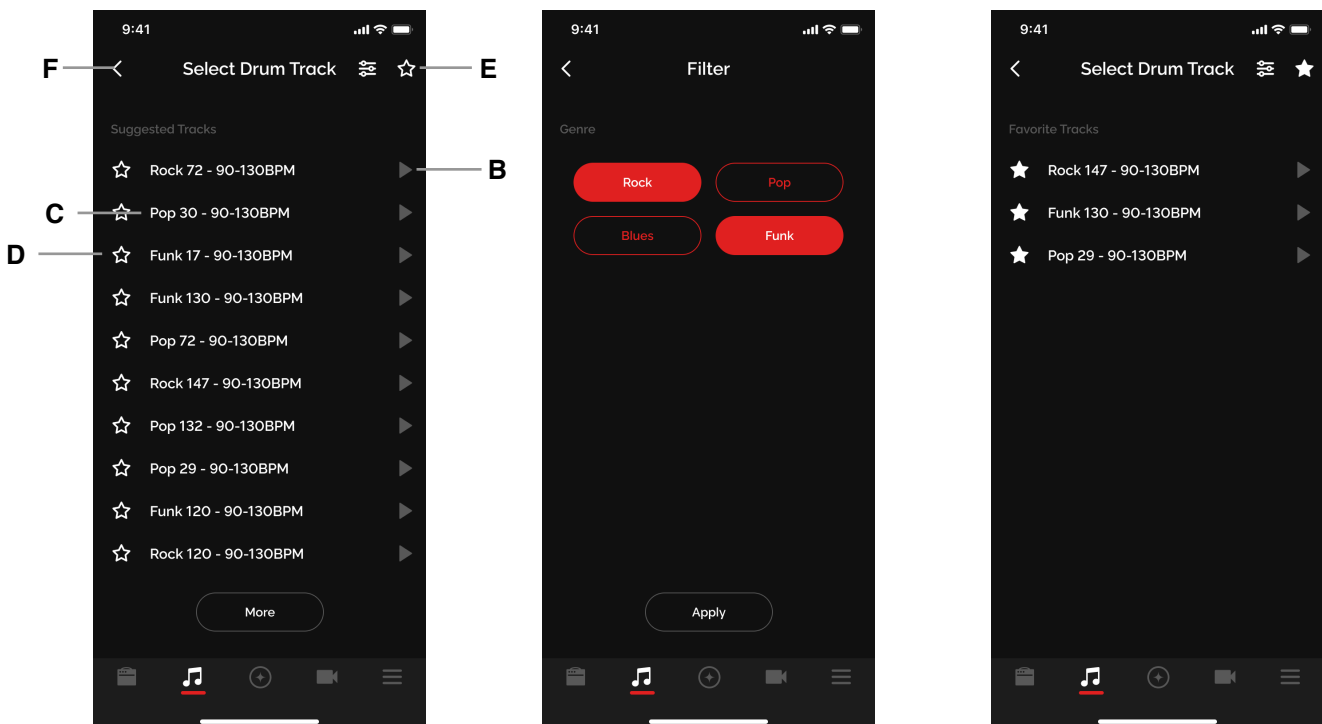

Drum Selection Menu

- (B) Preview: tap on the play button next to the drum pattern name to preview the drum pattern
- (C) Select: tap on the name of the drum pattern you want to select to load the drum pattern
- (D) Add to Favorites: tap on the star next to the drum pattern to save the drum pattern to your favorites
- (E) Favorites: tap on the star on the top right to access your favorites
- (F) Filter: tap on the filter button on the top right to access the filter and filter between genres
 - (i) Drums will be randomized every time you enter the Drum Selection menu
 - (ii) You may change the drum track when a loop is recorded, but only when playback is stopped.

Groove Looper: Start Recording



Start Recording

- (A) After selecting drums, tap on the Record button in the middle of the bottom circle. A drum fill in will begin and after 4 beats, the recording will start.
1. Recording will automatically stop once the loop length is reached.
 2. If you tap the record button during this step, you will stop the recording, however the length of the loop will be the same depending on the length you set in the time settings. Playback will begin from the point you pressed stop, so the loop will only have drums until it replays the loop.
 3. If you make a mistake, tap on the Retake button to immediately go back to the count in step to immediately start recording again
 4. After a recording is complete, you may not adjust time settings until you discard the loop.

Groove Looper: Dub, Undo/Redo



Dub, Undo/Redo

- (A) Tap on the center of the bottom circle to begin dubbing
1. Dub will start from whenever you pressed the dub button.
 2. You may dub as many layers as you want
 3. The dub can also be as long as you want, it will record over the loop e.g if the base recording is 10 seconds, a dub can be 20 seconds (2 loops of the base recording), meaning you dubbed over two cycles of the loop.
- (B) Undo/Redo functionality:
1. Tapping on undo will remove the last recorded layer. The button will switch to Redo
 2. Tapping on redo will restore the layer. The button will switch to Undo
 3. If there are no dubs present, undo and redo functionality will be disabled
 4. When undo is triggered and the last recorded layer is removed, and a dub is triggered, once the user presses stop dubbing, the previously removed layer will be discarded forever and may not be restored via the redo button. The button will become the undo button once a dub is finished recording.

Groove Looper: Discard a Loop, Mixer

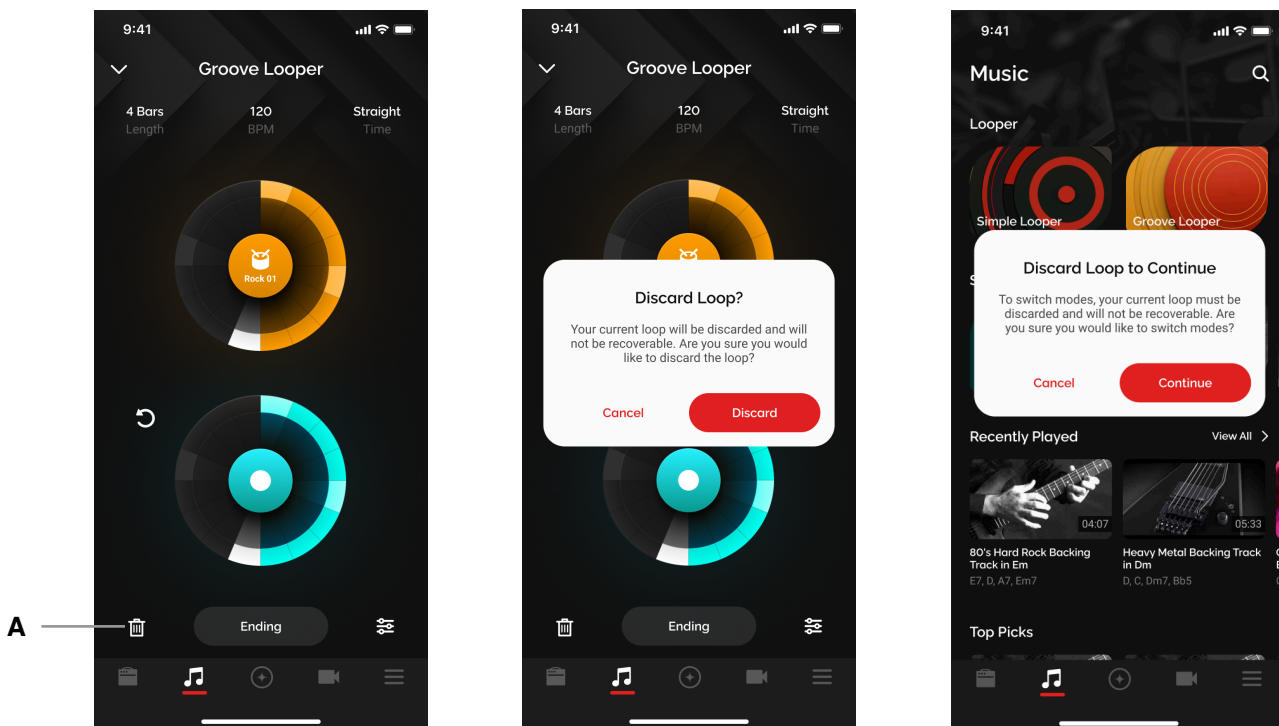

Discarding a loop

- (A) Tap on the Discard icon on the bottom left to discard a loop. A dialog box will appear to confirm your action.
1. When switching between the Simple and Groove looper, the loop must also be discarded.
 2. If you do not discard a loop, the loop will be stored on the Spark 2 hardware indefinitely until either you discard the loop or perform a factory reset.
 3. A Groove Looper loop that is stored in hardware requires the app to be connected to playback.

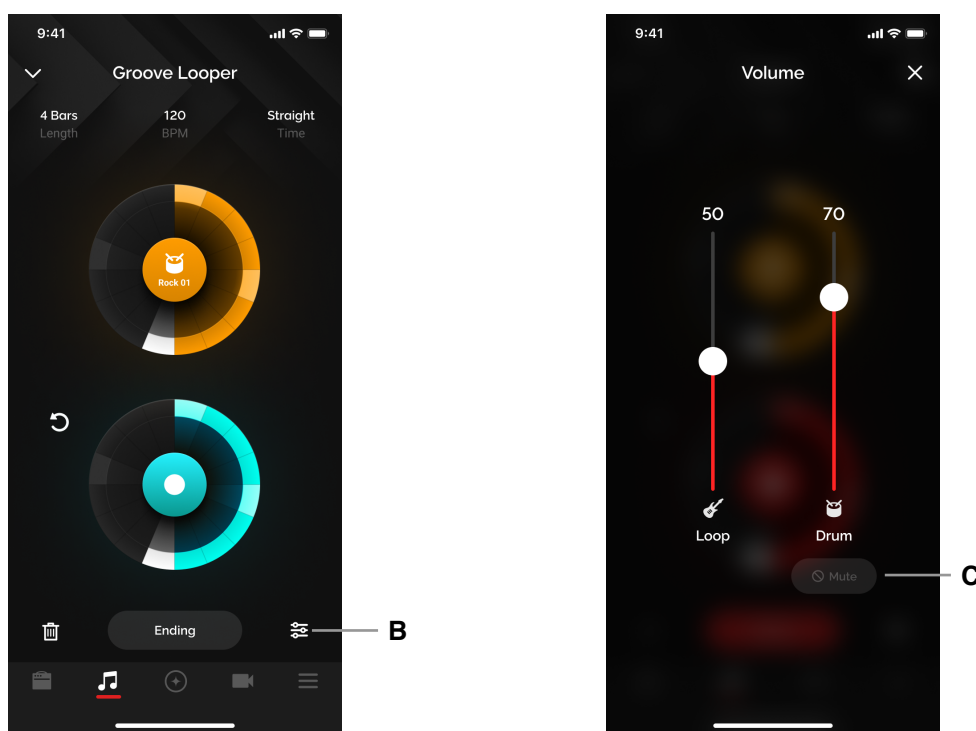

Mixer

- (B) Tap on the Mixer icon on to access the mixer, where you can adjust the loop and click volume
- (C) Tap on the Mute button to mute the drums during playback

Tip: Drum volume is also dependent on your mobile device's volume setting. Turn it up and adjust accordingly.

Using Spark AI

Spark AI is a revolutionary new way to discover tones. Describe a tone and Spark AI generates a tone based on your prompt.

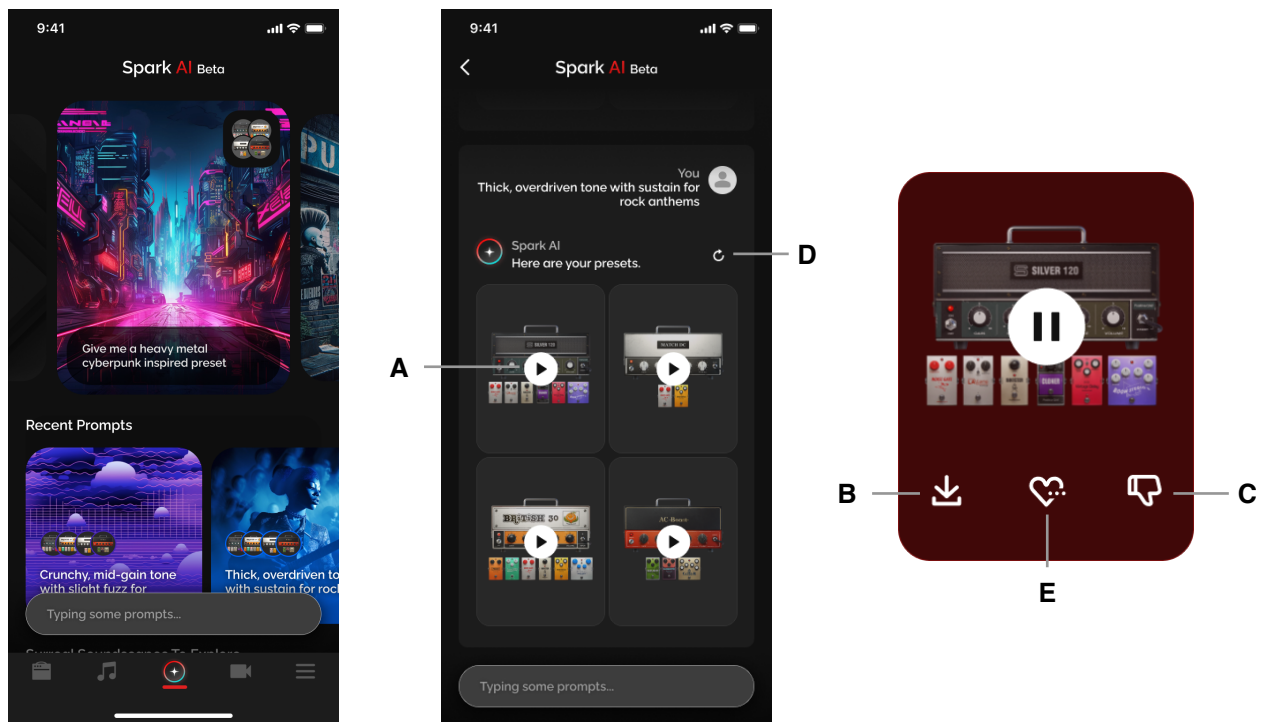

To begin, ensure that the Spark app is connected to your Spark amp's Tone Control connection and that you are logged in to your Positive Grid account.

1. Tap on the Spark AI icon at the center of the bottom bar
2. Tap on our predefined prompts or type in your own prompt in the text box at the bottom
3. Spark AI will bring you to the results page:
 - (A) Tap on the Play button to preview the tones generated by Spark AI
 - i. Preview works the same way as the ToneCloud, you must have a guitar connected and play the guitar yourself to preview what the tone sounds like
 - (B) Tap on the Download button to download the preset to your local presets
 - (C) Tap on the Dislike button to teach Spark AI that the preset does not match the prompt given
 - (D) Tap on the Refresh button on the top right to refresh the list.
 - i. You may refresh the list up to 5 times.
 - ii. Once refreshed, the previous results will be discarded.
 - (E) Tap on the More Like This button in the center of the selected preset to prompt Spark AI to find similar presets.

Using Smart Jam

Spark Amp and app work together as one unit to learn your style and feel, then generates authentic drums and bass tracks to accompany you.

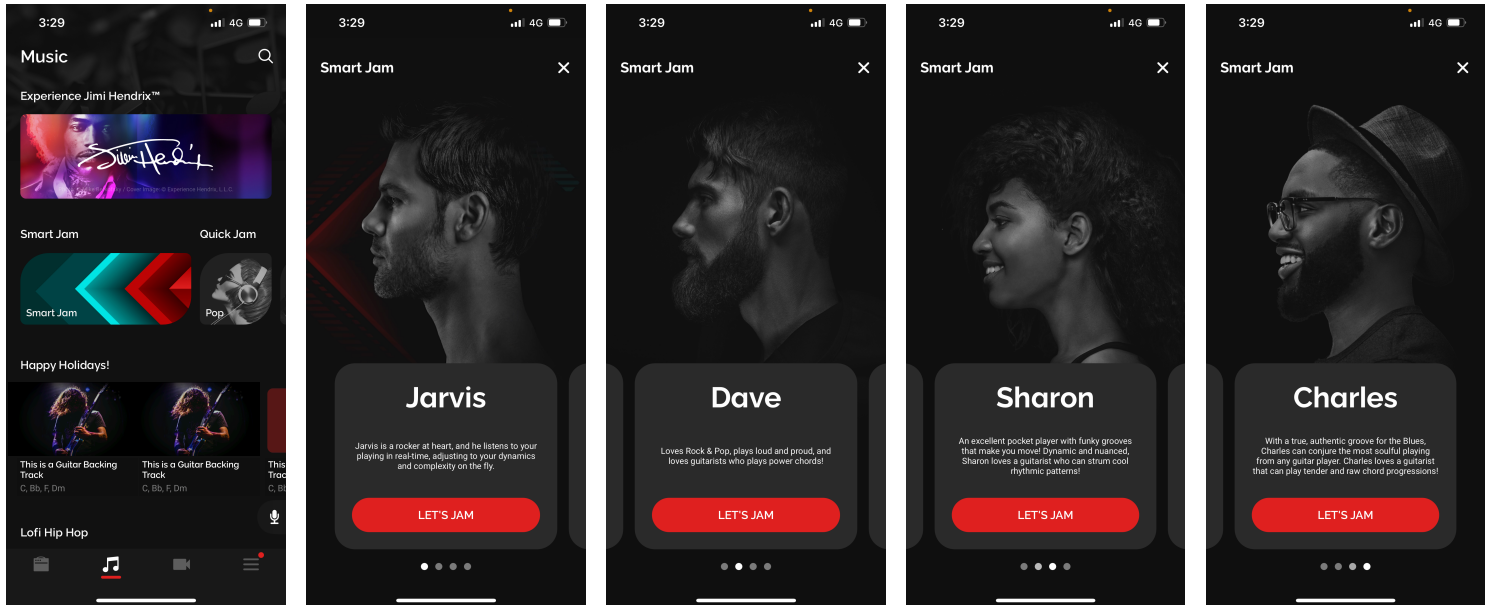

Make sure you are connected to your Spark device's Bluetooth Audio, then tap on the Music page and tap on the Smart Jam banner. Select 1 of the 4 drummers available by swiping left or right to begin.

- Jarvis

Jarvis is a rock-style drummer who will listen to your dynamics and feel while you're playing, and provide you with real-time feedback with louder or softer hits, and more simple or complex grooves. [More on that later.](#)

- Dave

Dave is a Rock style drummer who hits hard and hits loud! Dave will listen to your chords and create a backing track that follows a song structure, with a Verse, followed by a Chorus, then a Bridge, and another Chorus, according to what you played.

- Sharon

Sharon is a Funk style drummer with grooves that make you move! Sharon will also listen to your chords and create a backing track that will follow a song structure according to your initial chord progression and strumming pattern.

- Charles

Charles is a Blues style drummer who plays to help you bring out your most soulful playing. With Charles, you can choose between a straight and shuffle feel, and between an 8-bar or 12-bar blues progression. Once you've selected the feel and BPM, start playing your desired chord progression and let the blues take over!

Playing With Dave/Sharon/Charles

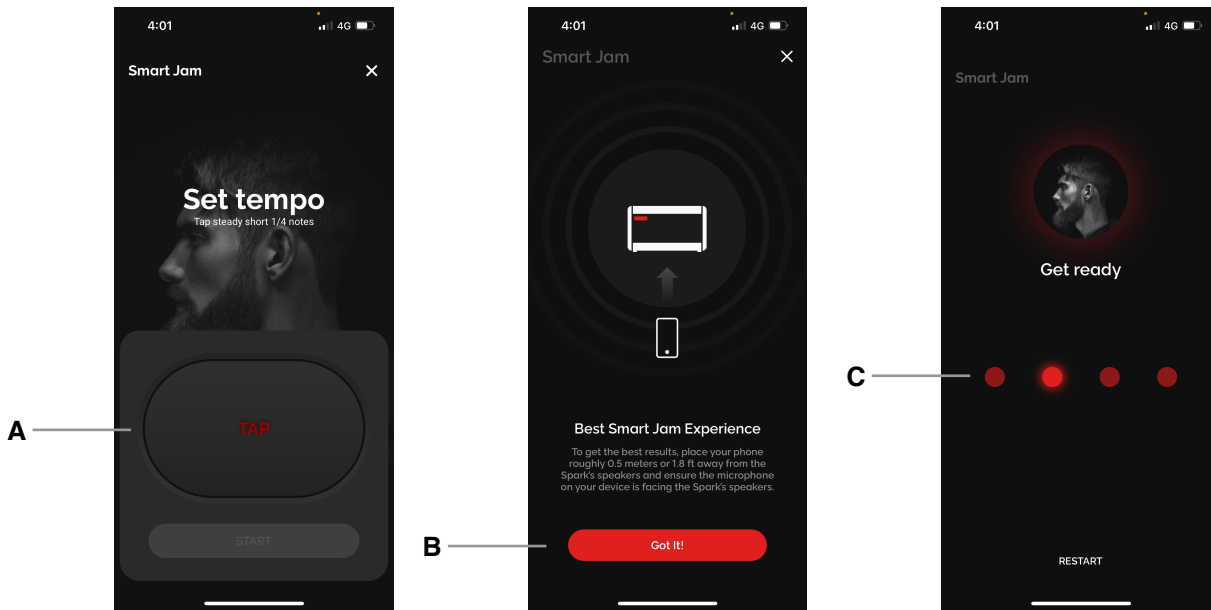

- A. Set a tempo by tapping the TAP button to tap a tempo. You may adjust in increments of 1 with the +/- sign once an initial tempo has been set, and increments of 10 by tapping and holding the buttons, then tap Start.
- B. For first time Smart Jam users, you will be reminded to place your device roughly 0.5 meters or 1.8 feet away from your Spark's speakers, with the microphone facing the Spark amp's speakers for the best results.
- C. You will be given 4 beats to count you in. If you do not hear the clicks, please ensure that your device is connected to Spark's Bluetooth audio and that your device and Spark's music volume is turned up.

- D. The drummer will listen to your playing after the 4 initial beats. All the Smart Jam drummers currently support 1 chord every 2 beats. Make sure to observe the red bar at the bottom of the screen; when the red line goes across the entire screen, it means you have clipped the microphone on your device, and the results may not be accurate.
 1. You may play up to 8 bars, but if your chord progression is only 4 bars, you may tap the checkmark button when it's highlighted on the screen to skip the last 4 bars.
 2. Once the analysis is complete, select from the 6 tracks that have been created by the drummer that you like best. Swipe left or right to scroll between each option and preview the tracks.

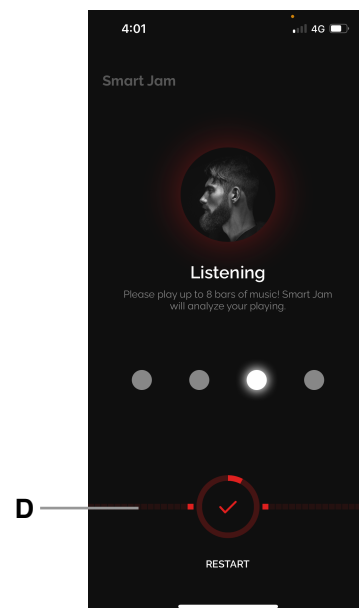

Playing With Dave/Sharon/Charles

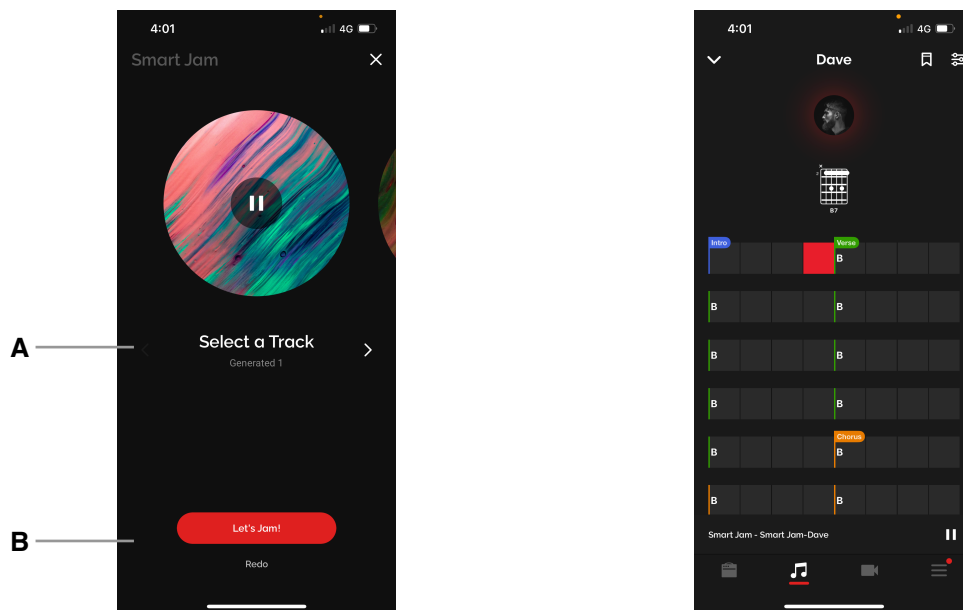

- Once the analysis is complete, select from the 6 tracks that have been created by the drummer that you like best. Swipe left or right or tap the arrow icon to scroll between each option and preview the tracks.
- After selecting a track, you will be taken to the Smart Jam detail page where you can start jamming! Tap redo if you'd like to record another chord progression.

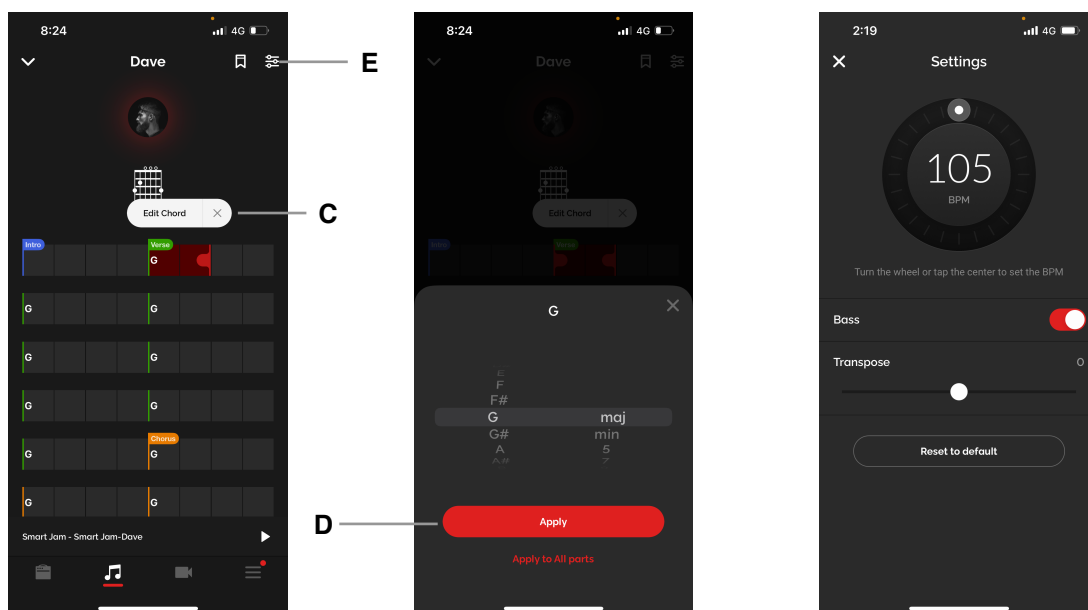

- You may edit the chords by pausing the track, then long pressing any of the chords then tapping Edit Chord. Select more than one bar by dragging the red indicator to the right of the selected area.
- After changing the chord to your desired chord, tap apply to apply the chord change just to the selected range, or tap Apply to All Parts to apply the chord change to all sections of the Smart Jam track.
- Tap on the Settings icon on the top right to go to the Smart Jam settings menu, where you can adjust BPM, turn off the Bass track, and transpose the track by increments of half steps to a maximum of an octave up or down. Tap Reset to default to reset to the initial analyzed or saved settings.

Playing With Jarvis

Jarvis is unique in that they will listen to your playing in real time and change along with your dynamics and complexity of your playing while you play.

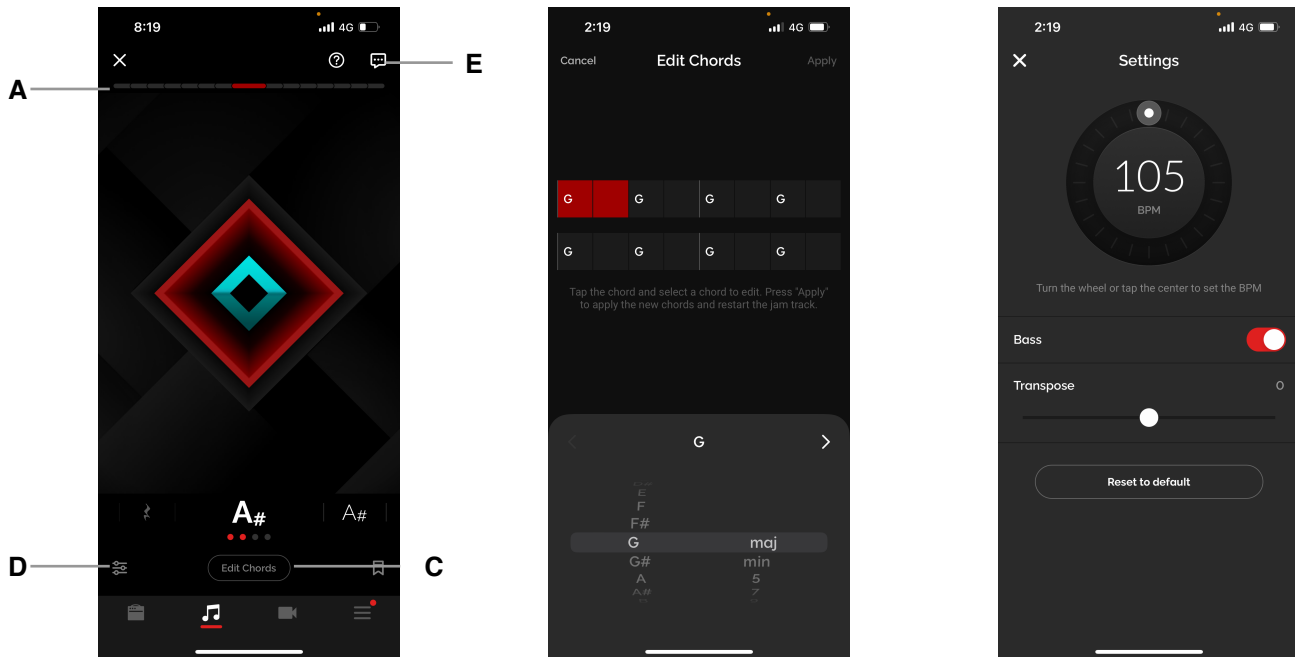

Follow the steps for playing with Dave/Sharon/Charles:

- A. For the best real time jamming experience, observe the top red bar and do the following calibration during your first play through with Jarvis:
 1. At your loudest playing level, ensure that the top red bar is almost at maximum. If it's at maximum, it indicates that your device's microphone is clipping; turn the volume of your instrument and music accordingly to ensure it's not clipping.
 2. At your quietest playing level, ensure that the top red bar is at roughly 3 red blocks. This minimum and maximum range will have better dynamic detection.
 3. Make sure your guitar is louder than the backing track. Try to aim for a volume balance with your guitar and backing track at roughly 2:1 or 2:1.5. This will make it easier for Jarvis to detect your guitar playing.
- B. To edit chords, tap the Edit Chords button, then select the chord you'd like to edit. Once you've changed your desired chords, tap Apply to apply the changes to the track.
- C. Tap the Settings icon on the bottom left to change the jam track's settings; you may adjust the tempo, turn off the bass, and transpose the track by increments of half steps and up to a whole octave up or down. Tap Reset to default to reset the track to the analyzed or saved version of the track.
- D. Leave feedback by tapping on the Feedback icon on the top right of the page, and to review instructions for using Jarvis, tap the Help icon next to it.

Saving a Backing Track

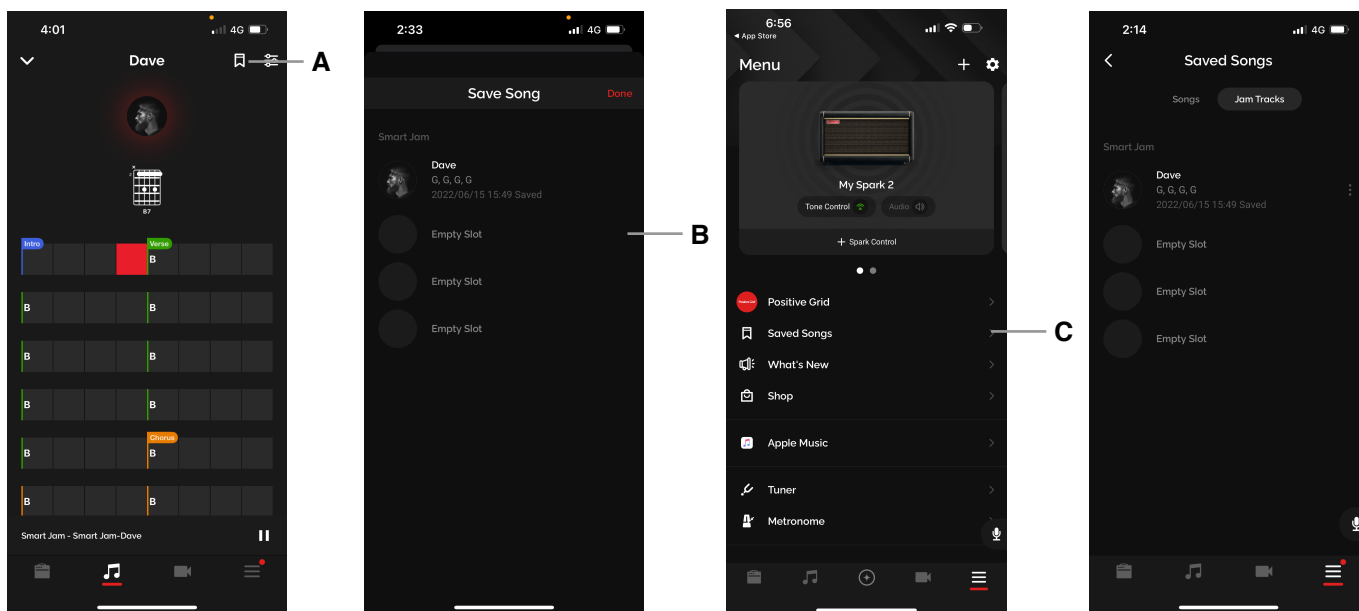

- A. You may save a backing track by tapping on the bookmark icon available in the Smart Jam detail page for all drummers.
- B. Select a save slot to save your backing track.
- C. Access your saved Smart Jam tracks from the Saved Songs page in the Menu, then select the Smart Jam tab. Tap on your desired jam track to load a previously saved Smart Jam track. You may also rename or clear the track from the slot by tapping on the  icon.

Starting a Quick Jam

Quick Jam is a collection of backing tracks that use the same audio engine as Smart Jam with preset chord progressions and grooves.

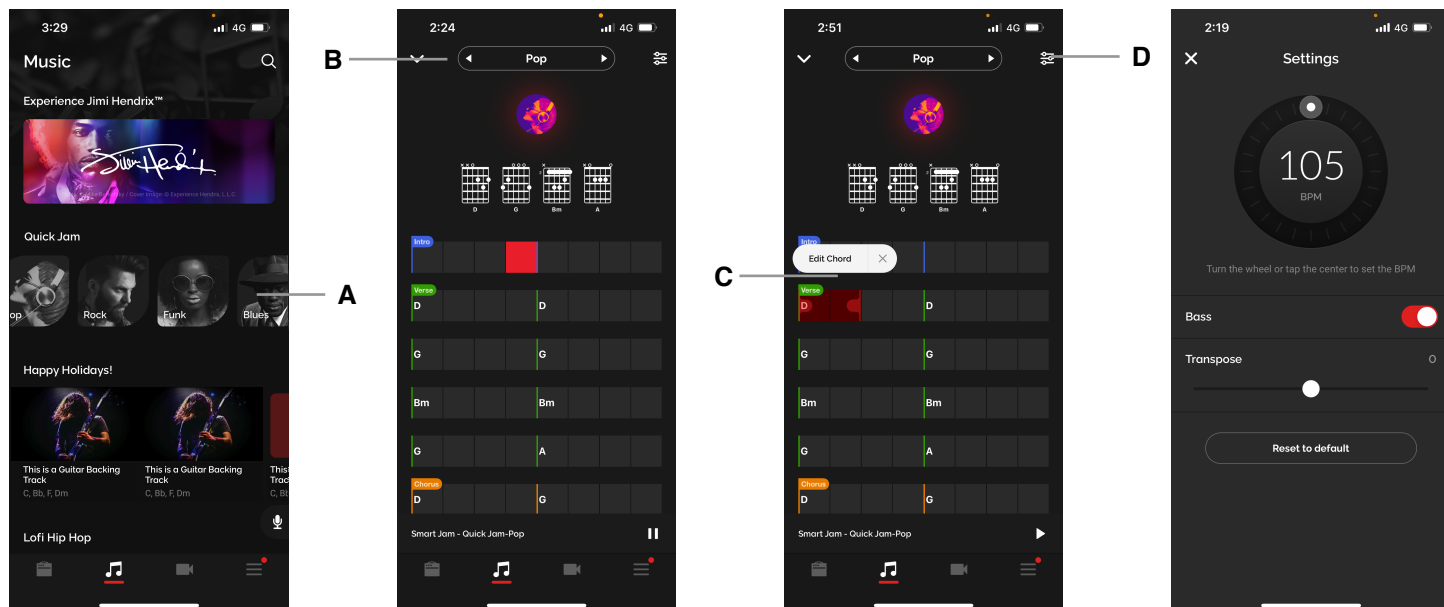

- A. Access Quick Jam by going to the Music page, then scroll the Smart Jam/Quick Jam banner horizontally to see the available genres; Pop, Rock, Funk and Blues. Tap into the genres to start the backing track.
- B. Tap on the left and right arrows next to the genre at the top of the page to switch between the designed tracks for each genre.
- C. Pause the track, then long press a chord to edit the chord, following the same steps as Smart Jam.
- D. Tap on the Settings icon on the top right to adjust settings. The same adjustments in Smart Jam are available here; you may adjust the tempo, turn off the bass, or transpose the track by increments of half steps up to an octave up or down. Tap Reset to default to reset the track to its initial default state.
- E. Any changes made will be automatically saved, and automatically loaded when you load up Quick Jam.

Using Auto Chords and Tones

Choose any song, and Spark will automatically display its chords in real time as you play. Intuitive controls easily let you slow down the song's tempo or loop a difficult section.

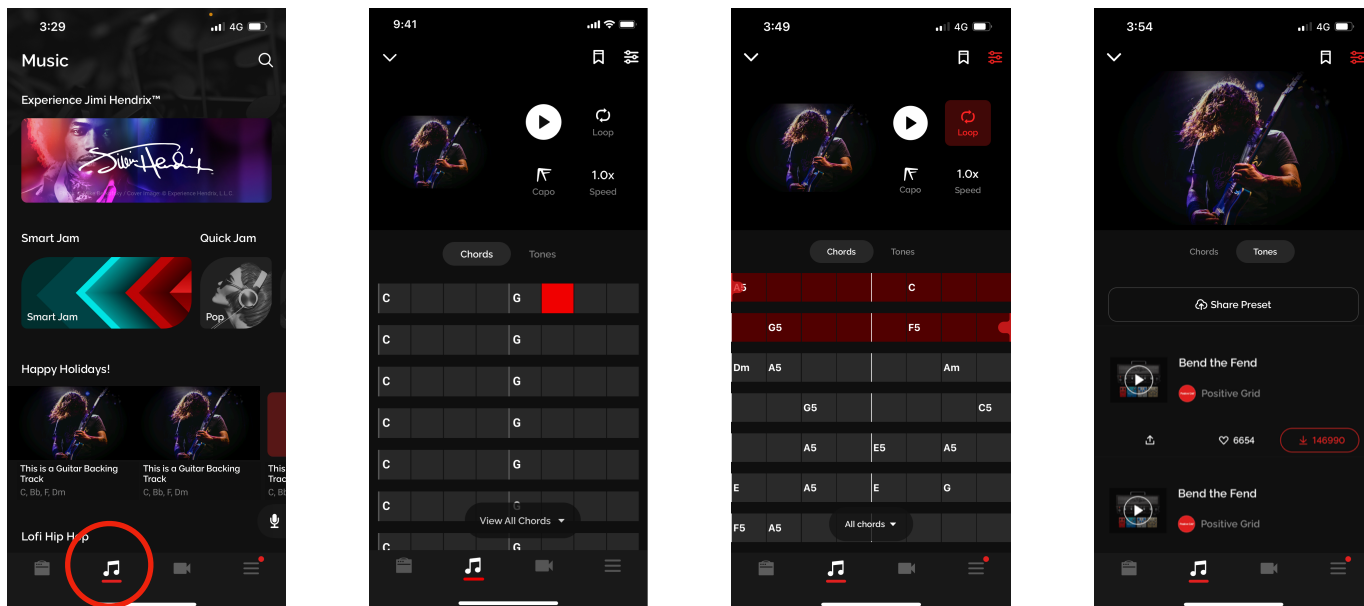

- (A) Go to the Music page and tap on our curated playlists to learn songs from those playlists.
- (B) Search for any song with the search bar at the top of the Music page to learn a song of your choice.
- (C) Tap on the Settings icon on the top right to access Music tools
 1. Tap on Loop and drag the handles to loop the selected section.
 2. Tap on Capo to change the chords to a capo'd version, allowing you to play with standard open chords.
 3. Tap on the Speed button to change the speed of the track to 0.5/0.8/1.0x speed to practice at a slower tempo.
- (D) Tap on Tones to bring up tones that are recommended for the song according to other users. Upload your own ToneCloud presets to contribute to this growing pool of tones!

Connecting Apple Music

Connect your Apple Music accounts to import your saved albums to the Spark app.

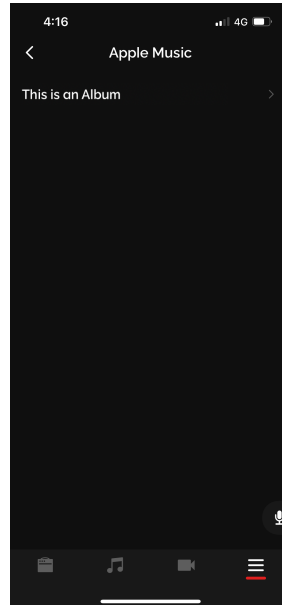
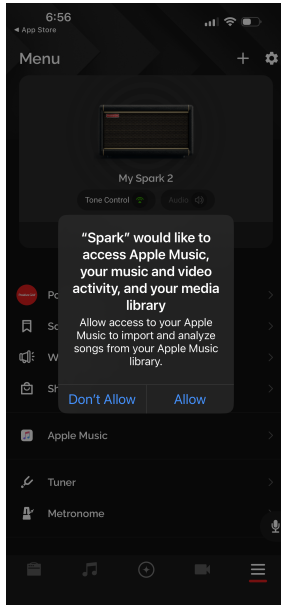

(A) Go to the Menu page and tap on Apple Music.

(B) Log in to your Apple Music accounts.

(C) Choose the desired album from your Apple Music list to import your albums into Saved Songs in the Menu page.

Tip: Make sure that Spark has access to your Apple Music account.

Recording Video

Record a video of your guitar playing from within the Spark app to record ideas or covers to share to social media.

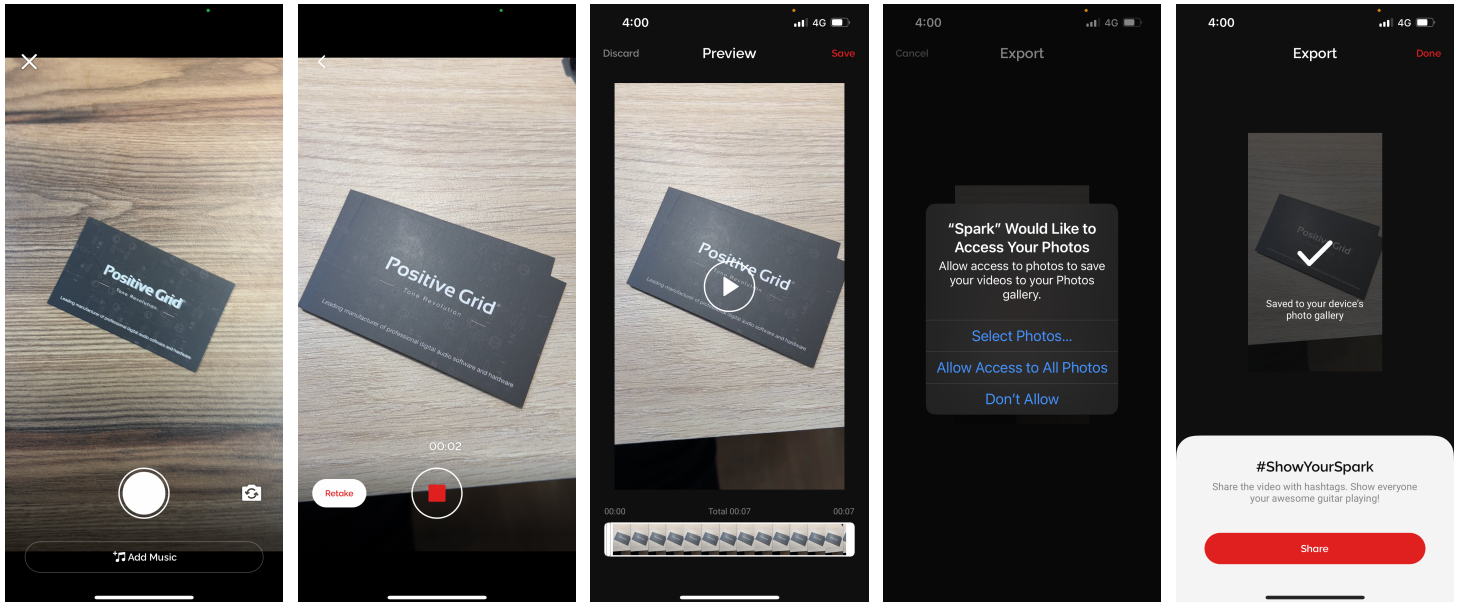

- (A) Tap the Video icon to open the Video Recording function.
- (B) Tap Add music to add a Smart Jam backing track or a locally saved music file to play along to while you record.
- (C) Tap the camera flip icon to switch between the front and back cameras of your device.
- (D) Tap the Record button to start recording, tap again to stop recording.
- (E) Tap Retake to begin another take without stopping your initial video.
- (F) Once you've finished recording your video, you may trim the beginning and end of the video to your desired length in the Preview Screen.
- (G) Tap Save to export the video to your camera roll. Make sure the app has access to your Photo library to save the video.
- (H) Tap share to share to social media or messaging platforms, or Done to continue.

Using Voice Command

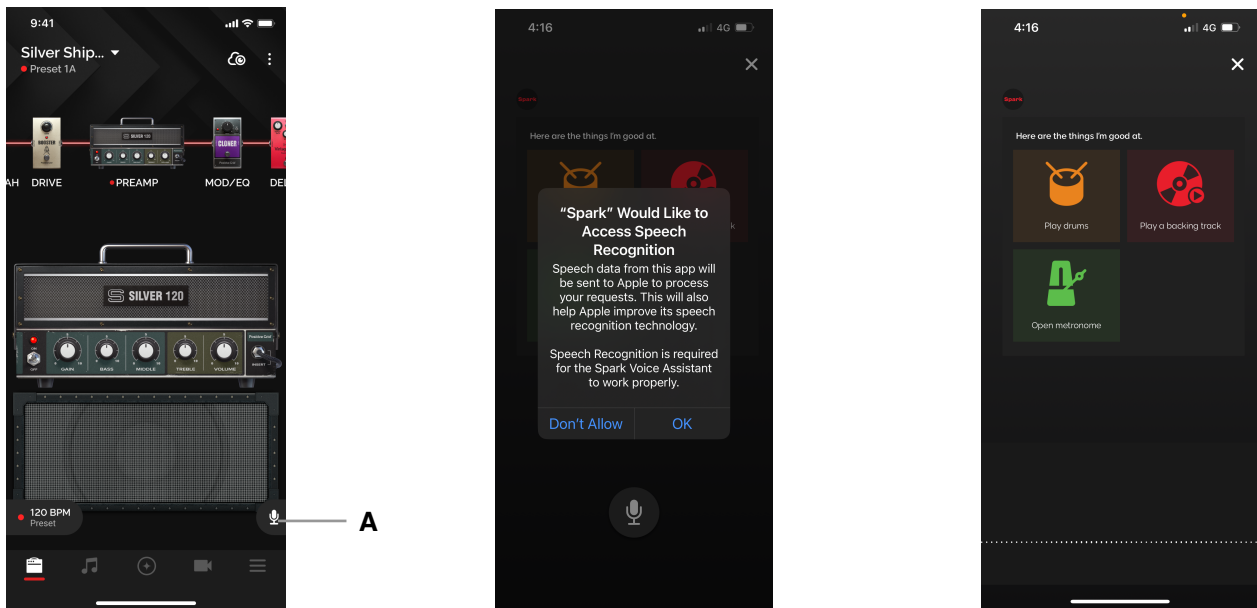

(A) Music Assistant

1. Tap the microphone icon. It is available in most pages.
2. Make sure to allow permissions for Speech Recognition and your devices Microphone to ensure the feature works properly.
3. Speak into your smartphone with the following voice commands. Alternatively, you can tap the on-screen quick commands.
 1. Play drums - Same as Smart Jam
 2. Play a backing track - Play a custom backing track.
 3. Metronome - Open Spark's built-in metronome

(B) Voice Command Language Support

1. English
2. Japanese

Tip: The Voice Command feature has three quick commands. Try them!

Device Card and Adjustments

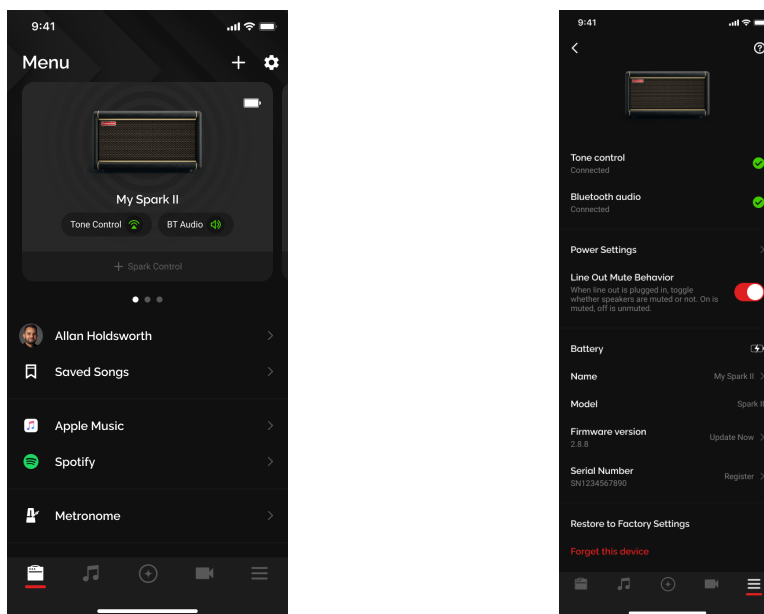

The Device Card can be accessed in the Menu page once you've connected your Spark Amp. Once it's connected, tap on the device at the top of the menu to access your Device Card, where several settings can be adjusted and statuses can be observed.

1. **Tone Control and Bluetooth Audio** - Shows the status of your Bluetooth connections between your device to the Spark Amp
2. **Power Settings** - Power Settings will allow you to adjust Spark 2's Auto Standby and Auto Shutdown features to save battery life.

Spark 2 will automatically enter a low power state after a set amount of time has passed where no audio is detected to preserve battery life. The time it takes to enter standby mode can be adjusted in this menu. While the Spark 2 is in this state, instrument output and music playback will be temporarily disabled. To enable audio output again, play your plugged in instrument or start audio playback to reactivate it.

3. **Line Out Mute Behavior** - Adjust whether the speakers should be muted or unmuted when the Line Outputs are connected. Default for Spark 2 is on.
4. **Battery** - Displays the battery status of your device.
5. **Name** - Change the display name of your Spark amp when connecting to your Spark.
6. **Model** - Displays the model of your Spark amp.
7. **Firmware** - Displays the firmware version installed on your Spark amp.
8. **Serial Number** - Displays the serial number and registration status of your Spark. If your Spark device is not registered, selecting this option will guide you through the registration process.
9. **Restore to Factory Settings** - Restores all settings to the factory defaults.
10. **Forget This Device** - Remove this device from your list of connected devices.

Updating the Firmware on Spark 2

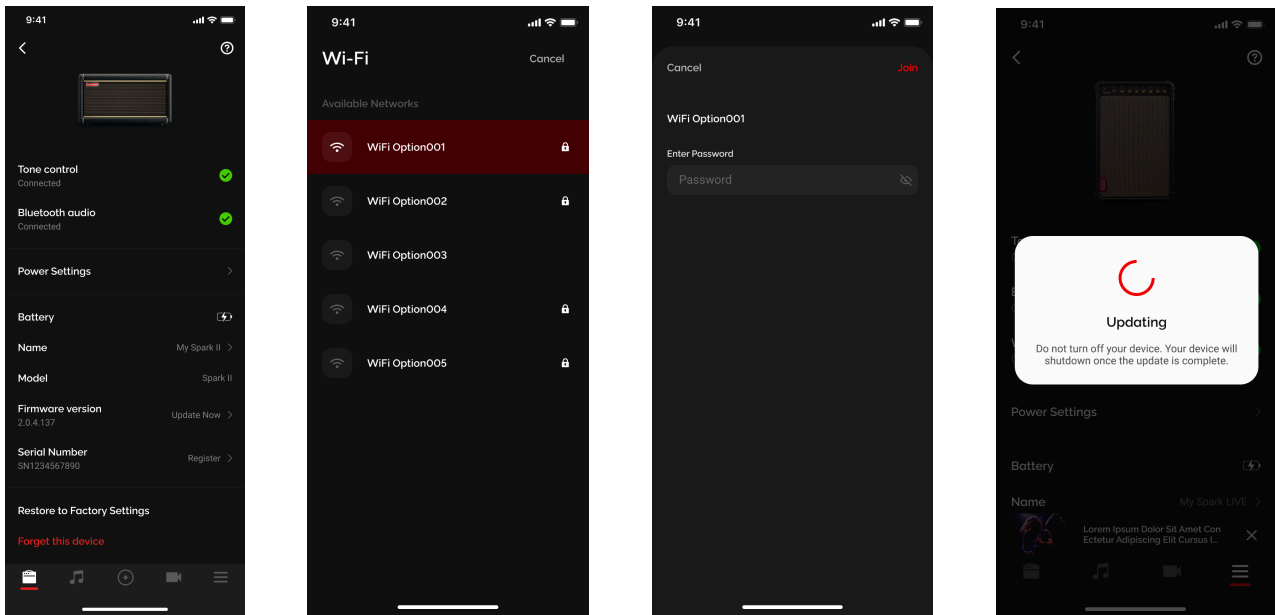

Spark 2 has the ability to update its firmware via Wi-Fi. Please make sure you are near a Wi-Fi access point with an internet connection and follow the instructions to update your firmware:

Connecting to Wi-Fi

1. Tap on the “Check for Update” button, a dialog box should appear asking to connect to Wi-Fi
2. Tap Connect. Your Spark 2 will search for available Wi-Fi access points. Select your access point and enter its password to connect.

Updating Firmware

1. Go into the device card of Spark 2 and tap on Check for Update or Update to update to the latest version.
2. Your device will automatically shutdown once the update is complete. Turn on your device and connect, then double check the Device Card to see whether the firmware update was successful.

Other Available Functions

Tuner and Metronome

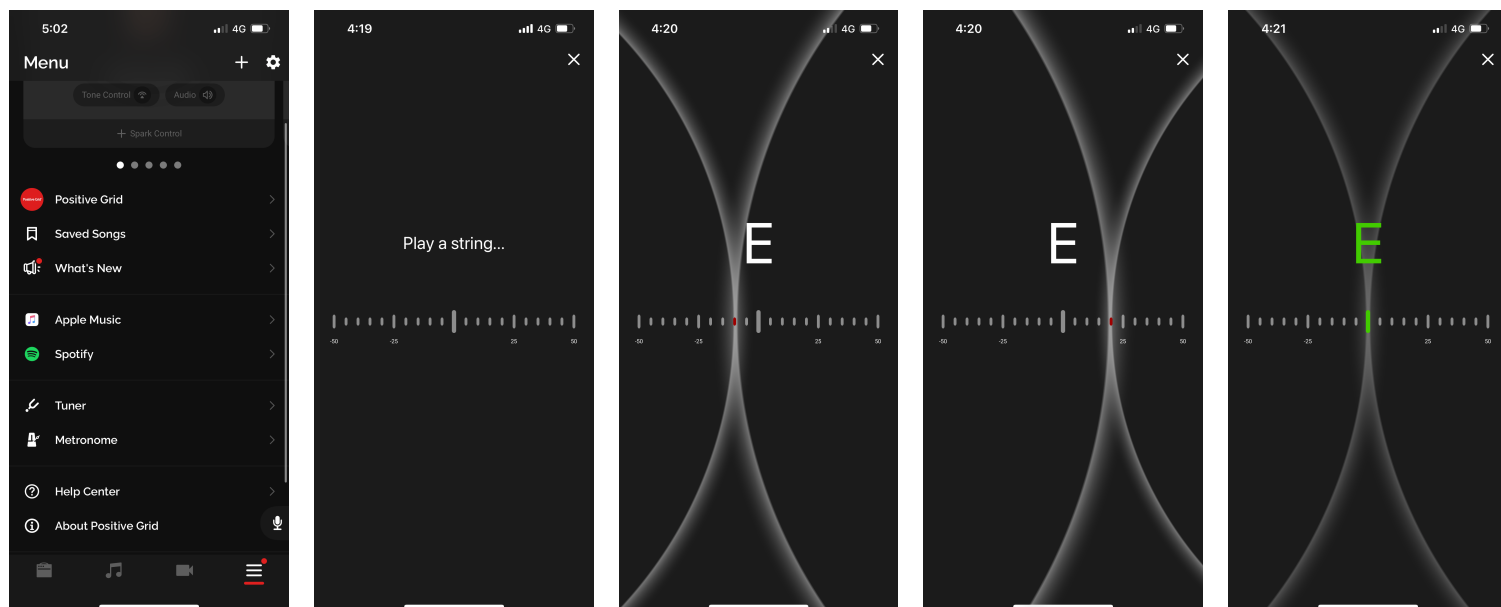

(A) Access the Tuner and Metronome by going to the Menu page and scrolling down, tapping on the desired tool.

(B) Once in the Tuner page, play your instrument to start tuning

1. If the line is to the left of the middle point, your instrument is below the target pitch
2. If the line is to the right of the middle point, your instrument is above the target pitch
3. Once the line is in the middle and the note turns green, the string is in tune and you may move on to tune the other strings to your instrument

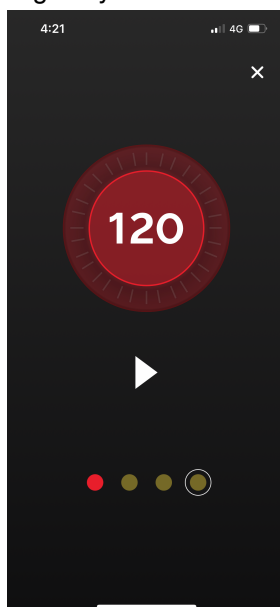

(C) In the Metronome page, tap on the number at your desired tempo to set the tempo. You may also press and turn the outer ring to adjust the tempo. Tap on the play button to start the metronome.

Other Available Functions

Back Up Presets to Dropbox

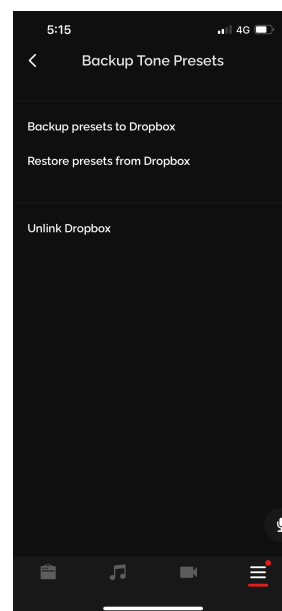
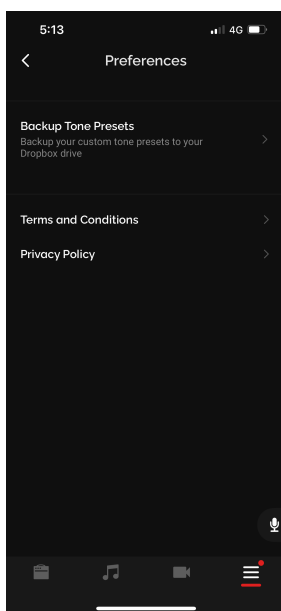
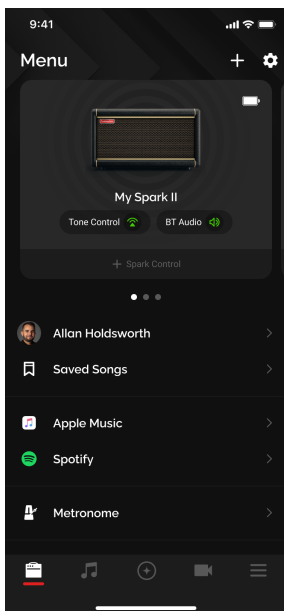

(A) To Back Up your presets to Dropbox, tap on the  icon at the top right of the Menu page.

(B) Tap on Backup Tone Presets and link your Dropbox account to the Spark app.

(C) Once linked, tap on Backup presets to Dropbox to backup your local presets, and tap on Restore presets from Dropbox to restore those presets.

Online Support

Visit our online Help Center for user manuals, FAQs, or to contact our support team.
Help Center: <https://help.positivegrid.com/>