



CineView Master 4K

For Production Masters

User Manual

v1.0

In the Box	[01]
Product Description	[04]
Product Features	[04]
Applications	[05]
Quick Start	[09]
Transmitter Settings	[15]
Receiver Settings	[21]
Accsoon SEE App	[23]
Firmware Update	[27]
Specifications	[29]
FAQs	[31]
Warranty	[32]
Warranty Process	[33]
Safety Information	[33]
Contact Us	[33]

TX/RX Kit



CineView Master
4K Transmitter X1



CineView Master
4K Receiver X1



Cold Shoe Mount
Adapter X2



2.4GHz/5GHz
Antenna X8



6GHz Antenna X4



USB-C to USB-C
Cable X1



USB-C to
Lightning
Cable X1



Allen Key X1



User Manual X1

TX Only Package



CineView Master
4K Transmitter X1



Cold Shoe Mount
Adapter X1



2.4GHz/5GHz
Antenna X4



6GHz Antenna X2



USB-C to USB-C
Cable X1



USB-C to
Lightning
Cable X1



Allen Key X1



User Manual X1

RX Only Package



CineView Master
4K Receiver X1



Cold Shoe Mount
Adapter X1



2.4GHz/5GHz
Antenna X4



6GHz Antenna X2



Allen Key X1



User Manual X1

02 / Product Description

Thanks for choosing Accsoon Tri-Band Wireless Video Transmission System – CineView Master 4K.

The CineView Master 4K – the world's first Tri-Band 4K60 wireless video transmission system for enhanced stability, with 25ms^[1] best in class low latency. It redefines wireless video with a fully end-to-end true 4K60 video quality and an extended 2.5km^[2] transmission range. With 8K processor and its powerful capabilities, the CineView Master 4K can simultaneously transmit via different streams to meet diverse applications.

In addition to SDI/HDMI monitoring, the Accsoon SEE App supports wireless connections on both Android and iOS mobile devices, offering professional monitoring features and the capability to upload camera footage to cloud platforms. The newly added MFi-certified wired connection on the transmitter transforms a connected iPad or iPhone into a fully-fledged professional camera-top monitor, significantly enhancing on-site monitoring versatility. One set of wireless transmission that meets diverse needs.

03 / Product Feature

- End to End True 4K60 Transmission
- Tri-band (2.4GHz+5GHz+6GHz) + DFS Wireless Transmission
- 25ms Best in Class Latency^[1]
- 2.5km Extended Long Transmission Range^[2]
- Multiple Video Streams for Diverse Applications
- TX: SDI Input, HDMI Input, HDMI Loop-out

- TX: MFi-Certified USB Video Out to iPhone/iPad
- Convert SDI Input Signal on TX to HDMI Output Signal on RX ^[3]
- Convert HDMI Input Signal on TX to SDI Output Signal on RX
- RX: SDI and HDMI Output Simultaneously ^[3]
- Monitoring on Up to 5 Devices
- Monitoring on Accsoon SEE App
- 8K High Performance A/V Processor
- Powered by DC Input and NP-F Battery
- Compatible with Accsoon V-Mount Battery Adapter
- Intelligent, Quiet Heat Dissipation
- Aerospace Grade Aluminum Alloy
- 1.05-inch Full-color LCD Display

[1] Measured when shooting 1080p/60fps video under low bitrate.

[2] Measured when shooting 1080p/60fps video under low bitrate with FCC compliance in an unobstructed, interference-free environment.

[3] Receiver's SDI can only output up to 1080p60.

04/Applications

Accsoon CineView Master 4K can transmit to up to 5 devices simultaneously – a combination of 1 wired connection and 4 wireless connections.

4.1 Wired Transmission

The CineView Master 4K's transmitter includes a USB-C Video Out port that can transmit both video and audio signals to iOS devices while simultaneously powering the connected device (5V/3A) via cable connection.

Compatible Devices: iPhone 12 above and later; iPad Pro 12.9-inch Gen 3 above and later; iPad Pro 11-inch Gen 3 above and later; iPad Gen 9 above and later; iPad Air Gen 4 above and later; iPad mini 6.
Number of simultaneous connections: 1.

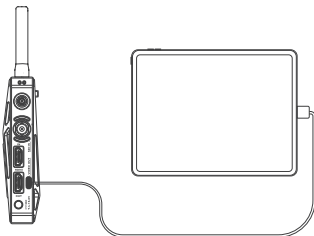

4.2 Wireless Transmission

The CineView Master 4K transmitter wirelessly transmits video and audio signals to the CineView Master 4K receiver, as well as to Android and iOS mobile devices via Wi-Fi.

Compatible Devices: CineView Master 4K receiver, Android phone/tablet, iPhone/iPad, Macbook (M1/M2/M3 Chip).

Number of simultaneous connections: 4.

Receivers and mobile devices can be mixed and matched for use:

Combination 1: 4 Receivers.

Combination 2: 3 Receivers + 1 Mobile Device (Android/iPhone/iPad/Macbook).

Combination 3: 2 Receivers + 2 Mobile Devices (Android/iPhone/iPad/Macbook).

Combination 4: 1 Receiver + 3 Mobile Devices (Android/iPhone/iPad/Macbook).

Combination 5: 4 Mobile Devices (Android/iPhone/iPad/Macbook).

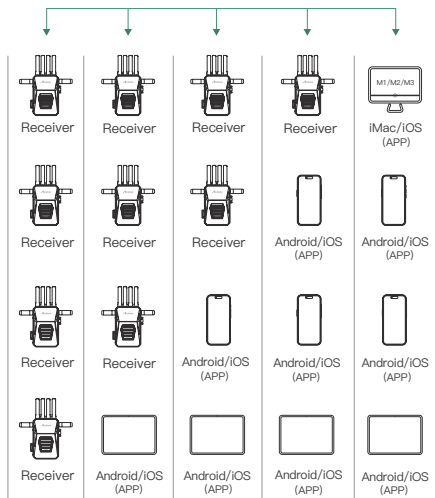
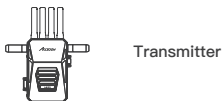
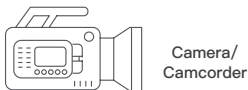

4.3 Multiple Video Stream Introduction

With the powerful capabilities of the 8K A/V processor, the CineView Master 4K can encode and transmit three different video streams at the same time to meet the diverse needs of different applications.

① Stream 1 (4K)

- Resolution up to 4K60, for wireless and wired USB transmission.
- Supreme resolution with best image quality at a closer range.

② Stream 2 (1080p Wireless)

- Resolution up to 1080p60, for wireless transmission.
- Maintain the balance of resolution, latency and transmission range.

③ Stream 3 (1080p Wired)

- Resolution up to 1080p60, for wired USB transmission.
- Monitor, stream, and record 1080p videos with superior bitrate.

Input Video	Video Stream	Wireless Receiver	Wireless Mobile Device	Wired USB Transmission
4K	Stream 1 (4K)	✓	✓	✓
	Stream 2 (1080p Wireless)	✓	✓	x
	Stream 3 (1080p Wired)	x	x	✓
1080p	Stream 2 (1080p Wireless)	✓	✓	x
	Stream 3 (1080p Wired)	x	x	✓

05 / Quick Start

5.1 Introduction

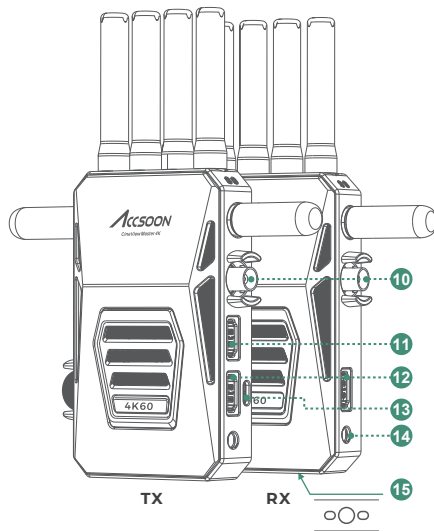
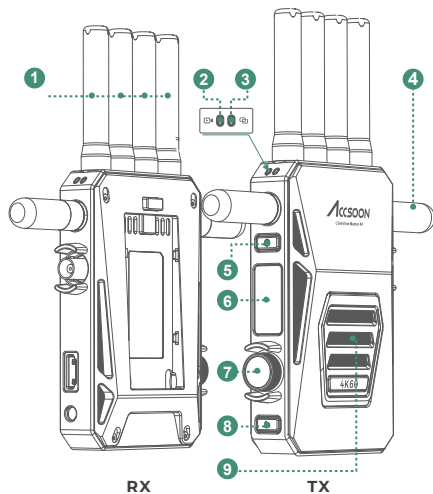

① 2.4GHz/5GHz Antennas

② Video Input Indicator

When powered on, the indicator will briefly light up.

When in use, the indicator turns on to indicate that a video input is detected, and turns off to indicate no video input detected.

③ Connection Status Indicator

When powered on, the indicator will briefly light up.

When in use, the indicator turns on to indicate that a receiver or mobile device is connected, and turns off to indicate no connection.

④ 6GHz Antennas

⑤ Power On/Off Button

Press 1 second to power on. Press and hold for 3 seconds to power off.

⑥ Full-Color LCD Display

Display device status and menu settings.

⑦ Menu/OK Knob

Rotate and press the knob to browse and modify menu settings.

Rotate: Browse menu pages and settings.

Short Press: Confirm selections.

⑧ Return Button

Return to the previous page, or cancel selection.

⑨ Air Intake

Note: Please don't block the air intake to ensure optimal performance.

⑩ 3G SDI

Transmitter: Input the SDI video signal.

Receiver: Output the SDI video signal.

⑪ HDMI In

Input HDMI video source.

⑫ HDMI Out

Transmitter: Loop out the video from the HDMI input to other devices.

Receiver: Output HDMI video signal.

⑬ VIDEO OUT

Wired USB video output port. Output video to iOS devices.

⑭ DC Power Input

For DC adapter power inputs.

⑮ Anti-rotation 1/4" Screw Hole

5.2 Antenna Installation

As shown, install the 2.4GHz/5GHz dual-band antennas to the top of the CineView Master 4K, and the 6GHz antennas to the sides.

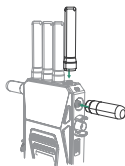

5.3 Mounting

Mount the CineView Master 4K to the camera or other device using cold shoe mount or other mounting accessories.



5.4 Power Supply

CineView Master 4K supports NP-F series batteries and DC power supply. The power supply system supports hot-swapping, i.e., when DC power is supplied, the NP-F batteries can be replaced without powering down the device and vice versa.

NP-F Batteries

To install the NP-F970/F750/F550 batteries into the CineView Master 4K:

Insert the battery into the slot at the back of the CineView Master 4K as shown in the illustration. **Push down** on the battery until you hear a “click” sound, ensuring it is securely installed.

To remove the battery, press the battery lock and pull the battery out.

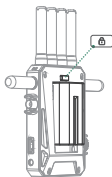

DC Power

Please use the corresponding DC adapters:

- Connector: 5.5mm x 2.1mm.
- Input Voltage: 7.4–16.8V.
- Center Positive.
- Output current should be no less than 2A.
- It is recommended to use a 9V/2A or 12V/2A DC adapter.

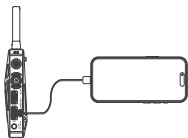

- iOS Device (USB-C Port): Use a USB-C to USB-C cable.
- iOS Device (Lightning Port): Use a USB-C to Lightning cable.



USB-C to
USB-C cable



USB-C to
Lightning cable

-
- △ 1. Only the Accsoon proprietary USB-C to Lightning cable can be used for connecting the CineView Master 4K's transmitter to iPhone/iPad.
2. In addition to the accessories that come with the product, other accessories required for installation need to be purchased by the user.
-

5.5 Connection

Use SDI or HDMI cables to connect the CineView Master 4K with camera and other monitoring devices.

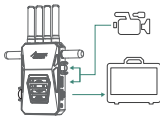

5.6 Wired USB Video Output to iOS Device

Use the provided USB-C to Lightning or USB-C to USB-C cable to connect the transmitter's VIDEO-OUT port to your iOS device for wired video transmission.

5.7 Power On/Off

Power On: Press the power button for 1 second, the LCD screen and both indicator lights will turn on.

Power Off: Press and hold the power button for 3 seconds to power off.

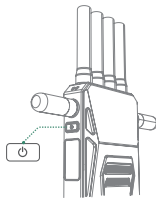

5.8 Group Setting

Please pair the transmitter and receiver(s) before use. (refer to 6.3 Group Setting/Pairing).

06/Transmitter Settings

6.1 Transmitter UI Instruction

Home Page

Displays the current operating status of the transmitter.

① Battery Level/Power Supply Status

Display the battery level of the current battery in use.
Display a powering icon when DC power is connected.

② Connected Devices

Display the number of connected devices.
If no devices are connected, display "0".

③ Current Frequency Operating Status

Yellow: The current frequency is enabled.
Grey: The current frequency is disabled.

④ Current Group

Current group of the transmitter. A total of 16 groups can be selected.

⑤ 5GHz Wi-Fi Operating Channel

Current 5GHz Wi-Fi operating channel. "AUTO" indicates automatic channel selection.

⑥ Video Input Information

Display the resolution and frame rate of current video input.
Display "NO INPUT" when no video input is detected, with the icon turning grey and flashing.



Wi-Fi Information

Displays current Wi-Fi information and menu settings.

① 5GHz Operating Channel

Display and set current 5GHz Wi-Fi operating channel.

② Current Group

Display and set group information of the transmitter.



③ Region Code

Display and set region code of the transmitter.

④ Reset

Network reset.

⑤ Wi-Fi Name

Current 5GHz Wi-Fi name of the transmitter. To change the Wi-Fi name and password, Please use Accsoon SEE App.

Audio/Video Information

① Video Encoding Format Information

Display current input video's resolution, frame rate and current encoding standard.
This setting cannot be changed.

② Video Input Status

Green indicates video input detected.
Grey indicates no video input.

③ Audio Input Status

Green indicates audio input detected.
Grey indicates no audio input.

④ Wireless Bitrate Setting

Display and set the wireless video transmission bitrate from 1-12, maximum 12.

⑤ Wired USB Bitrate Setting

Display and set the wired USB video transmission bitrate from 1-12, maximum 12.

⑥ VBR/CBR Setting

Choose and select CBR or VBR in accordance to different applications.



System Information

① Fan Speed.

② Device Temperature.

③ Fan Mode Setting.



Device Information

- ① Device Name.
- ② Current Firmware Version.



6.2 Channel Setting

1. The Channel Setting is available exclusively on the transmitter.
2. By default, the channel setting is set to Automatic (A). Once powered on, the CineView Master 4K will automatically select the channel with the least interference based on the current wireless environment.

- △ 1. It is recommended that users do not modify this setting.
2. The available channels will be different according to RF regulations in different countries and regions.
 3. In the “Channel Setting” page, channels with green background stands for current selected channel, and channels with “DFS” stand for DFS channels.

How to:

Rotate the knob to enter the “Wi-Fi INFO” page → Press the knob to select **165%** → Press the knob again to enter the “Channel Setting” page → Rotate the knob to select the channel → Press the knob to confirm → When the device indicates to reboot, click “Yes” → Reboot prompt displays, click “Yes” → The transmitter will reboot automatically, and the changes will take effect.



6.3 Group Setting/Pairing

1. The transmitter and receiver will automatically pair and connect when their group settings match. If the group settings do not match, pairing will not occur.
2. To transmit from one transmitter to multiple receivers, simply set all receivers and the transmitter to the same group.
3. When using multiple transmission systems in the same application scenario, ensure that each system has different group settings.

- △ If the group settings are changed, a reboot is required for the changes to take effect. After changing the group settings, successful pairing at close range is necessary before use; otherwise, group pairing might fail.

How to:

Rotate the knob to enter “Wi-Fi INFO” page → Press the knob to select **Grp 12** → Press the knob again to enter the “Group Setting” page → Rotate the knob to select the group number → Press the knob to confirm the selection → When the device indicates to reboot, click “Yes” → Reboot prompt displays, click “Yes” → The units will reboot automatically, and the changes will take effect.

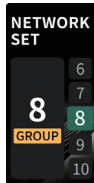

Grouping Conflict:

Accsoon Master 4K supports up to 16 TX/RX groups operating in the same environment. If, during startup, the transmitter detects other transmitter is set to a same group, a group conflict prompt will be displayed.



User needs to select another group → Reboot prompt displays → Select “Yes” to reboot.



6.4 Region Setting

- △ 1. The device's region code is pre-set based on your purchase location. Please do not change the region code. If changes are necessary, ensure the region code complies with the RF regulations of your current location. Accsoon Technology is not liable for any legal issues arising from incorrect region settings that violate local laws and regulations. For questions about changing the region code or any related inquiries, please email support@accsoon.com.
2. Some countries/regions share the same channels, to simplify the settings, not every country/region has a corresponding unique region code. If you have any questions, please email support@accsoon.com for assistance.

How to:

Rotate the knob to enter "Wi-Fi INFO" page → Press the knob and select   US → Press the knob again to enter "Region Setting" page → Rotate the knob to select the region → Press the knob to confirm → When the device indicates to reboot, click "Yes" → Reboot prompt displays, click "Yes" → The transmitter will reboot automatically, and the changes will take effect.



6.5 Network Reset

Rotate the knob to enter "Wi-Fi INFO" page → Press the knob to select  Reset → When the network reset prompt displays, click "Yes" → When the device indicates to reboot, click "Yes" → Reboot prompt displays, click "Yes" → The transmitter will reboot automatically, and the changes will take effect.



6.6 Bitrate Setting

The CineView Master 4K transmitter supports bitrate changes for both wired USB transmission and wireless transmissions.

Wireless Bitrate Setting:

Rotate the knob to enter "AV INFO" page → Press the knob to select  nRate 11 → Press the knob again, enter "Wireless Bitrate Setting" page → Rotate the knob to change the bitrate → Press the knob to confirm → Setting completes, click the return button to go back to the home page.

- △ Wireless bitrate changes will affect both the receiver and App wireless video streams.

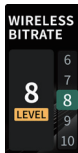

Wired USB Bitrate Setting:

Rotate the knob to enter "AV INFO" page → Press the knob to select  uRate 12 → Press the knob again, enter "USB Bitrate Setting" page → Rotate the knob to change the bitrate → Press the knob to confirm → Setting completes, press the return button to go back to the home page.

- △ Wired bitrate changes will only affect wired USB video stream.

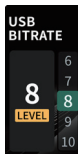

6.7 VBR/CBR Setting

Rotate the knob to enter "AV INFO" page → Press the knob to select  VBR → Press the knob again, enter "VBR/CBR Setting" page → Rotate the knob to select VBR or CBR → Press the knob to confirm → Setting completes, press the return button to go back to the home page.

- △ This setting will take effect on all three video streams (refer to 4.3).



6.8 Fan Setting

Rotate the knob to enter "SYS INFO" page → Press the knob to select **Standard** → Press the knob again, enter "Fan Setting" page → Rotate the knob to select the mode → Press the knob to confirm → Setting completes, press the return button to go back to the home page.

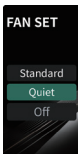

Standard: The device will adjust the fan speed automatically according to its temperature.

Quiet: Reduce the fan speed. The maximum fan speed is lower than Standard mode.

OFF: Turn off the Fan.

07 / Receiver Settings

7.1 Receiver UI Instruction

Home Page

① Battery Level/Power Supply Status

Display the battery level of the current battery in use.

Display a powering icon when DC power is connected.

② Connected Devices

Display "1" when successfully connected to the transmitter. Displays "0" when the device is not connected.

③ Wireless Operating Status

Yellow: The current frequency is connected to the transmitter.
Grey: The current frequency is not connected to the transmitter.

④ Group Status

Current group information of the receiver.
A total of 16 groups can be selected.



⑤ Video Input Information

Display the resolution and frame rate of the video signal received from the transmitter.
Display "NO INPUT" when no video input is detected, with the icon turning grey and flashing.

Wi-Fi Information

① Current Group

Display and set group information of the receiver.

② Wi-Fi Name

The 5GHz Wi-Fi name of the currently connected transmitter.



Audio/Video Information

① Video Encoding Format Information

Display current input video's resolution, frame rate and current encoding standard.
This setting cannot be changed.

② Video Input Status

Green indicates video input detected.
Grey indicates no video input.

③ Audio Input Status

Green indicates audio input detected.
Grey indicates no audio input.

④ Video Stream Priority Setting

Display current video stream priority setting, with options to switch the video stream priority between 4K and 1080P.



System Information

Same as transmitter.

Device Information

Same as transmitter.

7.2 Group Setting and Pairing

Same as transmitter.

7.3 Video Streams Priority Setting

Depending on the transmitter input, the receiver can pull different video streams from the transmitter (refer to 4.3 Multiple Video Stream Introduction). The video stream priority setting has two options.

Video Streams Priority is set to 4K: when the transmitter input is 4K, the receiver pulls 4K video stream; when the transmitter input is 1080p, the receiver pulls 1080p video stream.

Video Streams Priority is set to 1080p: the receiver pulls only 1080p streams regardless of whether the transmitter input is 4K or 1080p.

How to:

Rotate the knob to the right to enter the “AV INFO” page → Press the knob to select **1080P** → Press the knob again to enter the “Video Stream Priority Setting” page → Rotate the knob to select the desired video stream priority → Press the knob to confirm → Setting completes, click the return button to go back to the home page. During video stream switching, the receiver’s HDMI and SDI output will pause briefly.

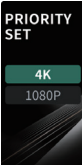

7.4 Fan Setting

Same as transmitter.

08 / Accsoon SEE App

8.1 App Download

Please download the App – Accsoon SEE from Google Play Store or iOS App Store. Download from Accsoon official website: <https://accsoon.com/download-center/>



8.2 Connection

Accsoon SEE App can receive the video from CineView Master 4K's transmitter via Wi-Fi or Wired USB-C transmission.

Wired USB Video Transmission

Compatible device: iPhone/iPad

Connect your iPhone/iPad to the USB-C VIDEO OUT port on the **transmitter** using the corresponding cable.

- iPhone/iPad (USB-C port): Use USB-C to USB-C cable.
- iPhone/iPad (Lightning port): Use USB-C to Lightning cable.

⚠ Only the Accsoon proprietary USB-C to Lightning cable can be used for connecting the CineView Master 4K's transmitter to iPhone/iPad.

Wireless Video Transmission

Compatible device: iOS/Android

Open the Wi-Fi settings on your mobile devices → Search for “Accsoon_****” and select it → Enter the default password “123456789” to connect.

- ⚠ 1. **** refers to the four characters consisting of numbers and letters that are unique to each product.
2. CineView Master 4K has multiple Wi-Fi signals. Please confirm the mobile device is connected to the 5GHz Wi-Fi, named “Accsoon_****”.

Wi-Fi



Accsoon_****



8.3 Monitoring

Once successfully connected, open the Accsoon SEE App, select “CineView Master 4K”, and then the “Start” button to start monitoring.



- △ The Accsoon SEE App is continuously updating. If you have any questions about using Accsoon SEE App, please refer to Accsoon SEE App tutorial videos on Accsoon's official YouTube channel, or send an inquiry email to support@accsoon.com for further information.

8.4 Video Setting

As shown below, users can choose to pull different video streams from the transmitter (refer to 4.3 Multiple Video Stream Introduction) and set the bitrate to meet the requirements of different applications.

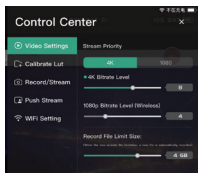

The video stream priority setting has two options.

Video Streams Priority is set to 4K: when the transmitter input is 4K, the receiver pulls 4K video stream; when the transmitter input is 1080p, the receiver pulls 1080p video stream.

Video Streams Priority is set to 1080p: the receiver pulls only 1080p streams regardless of whether the transmitter input is 4K or 1080p.

- △ The App pulls different 1080p streams from the transmitter via wired and wireless, please refer to 4.3 Multiple Video Stream Introduction.

Video Streams Priority Setting

Enter the monitoring page → Tap  to enter Control Center → Select "Video Settings" → Select "4K" or "1080p" according to the current video input.

- △ Processing and receiving 4K video wirelessly demands high processor performance from mobile devices. It's recommended to use the latest flagship models. If you experience choppy video, please lower the bitrate or switch to a 1080p video stream.

Bitrate Setting

Enter the monitoring page → Tap  to enter Control Center → Select "Video Settings" → Adjust the video bitrate according to the current video input.

- △ 1. When a mobile device is connected wirelessly to the transmitter, the bitrate setting will affect both the receiver and App wireless video streams.
2. When a mobile device is wired to the transmitter, the bitrate setting will affect only wired USB video stream.

8.5 Live-stream Setting

How to Start

Open Accsoon SEE App → Enter CineView Master 4K's monitoring page and tap  to enter Control Center → Select "Push Stream" and enter streaming RTMP/SRT URL and code → Tap "Start streaming".

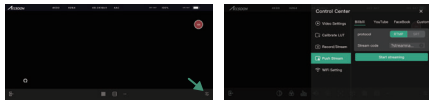

- △ 1. Before the streaming, please ensure that the mobile device can access the Internet via cellular data.
2. Please refer to the official website where you want to push the streaming for further instructions on how to obtain live streaming URL and code.
3. Please follow the recommendation of each live streaming platform to change the video bitrate setting. (refer to 8.4)

Live-stream with LUT Burnt-in

Load the LUT file in the App →
Enable “Record/stream with LUT
burnt-in” function under the
“Record/Stream” menu.

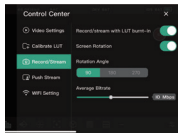

⚠ LUT files need to be uploaded by the user. Accsoon SEE
App supports LUT files in 3D Cube.

09 / Firmware Update

9.1 Before Update

1. Before the firmware update, please ensure that your mobile devices can access the Internet via Wi-Fi to acquire the latest firmware.
2. Please ensure that the battery level of CineView Master 4K units is above 50%.
3. Power on and pair the CineView Master 4K's transmitter and receiver(s).
4. No power cuts are allowed during the update process!
5. If you have any questions during the firmware update, please refer to “Accsoon SEE App Tutorial – Firmware update” video on Accsoon's official YouTube channel, or send an inquiry email to support@accsoon.com.

9.2 Firmware Download

Open the Accsoon SEE App, swipe to “CineView Master 4K” → Tap  to enter setting page → Tap “FIRMWARE UPDATE”, and then the App will automatically search for the latest firmware on the server → If a new firmware is available, follow the instructions to download the latest firmware to your mobile devices.

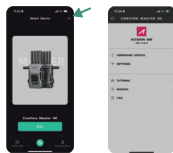

9.3 Update

Once the new firmware is downloaded →
Connect your mobile device to the transmitter's
Wi-Fi signal → Open Accsoon SEE App
and tap “Next” to send the firmware to the
transmitter → The transmitter will prompt “UP-
DATE” once received the firmware → Press
the knob and select “Yes” to start updating
→ The transmitter will reboot automatically.
Please wait until the reboot is fully completed
before proceeding, as the upgrade will only be
finalized once the reboot is finished.

When the transmitter completes its update, it will connect with other receiver(s) that are under the same group and update the receiver(s). The receiver(s) will prompt “UPDATE” → Press the knob and select “Yes” to start updating → The receiver will reboot automatically. Please wait until the reboot is fully completed before proceeding, as the upgrade will only be finalized once the reboot is finished.

9.4 Automatic Local Update

After power on, the connected transmitters and receivers will recognize and compare each other's firmware version. The unit(s) with a lower firmware version will be automatically updated. The unit(s) with lower firmware version will prompt “UPDATE” → Press the knob and select “Yes” to start updating.

9.5 Firmware Recovery

If the firmware update fails, the device will
automatically be restored to the factory
default firmware so that users can contin-
ue to use or update later.
Please do not power off the unit(s) during
the recovery process!

UPDATE

Proceed to
update.

YES

NO

RECOVERY

Update failed.
The device
will try again.
Please wait.

10 / Specifications

	Transmitter	Receiver
A/V Processor	8K A/V Processor	
Protocol	Proprietary RTMS4.0 protocol developed by Accsoon	
Video Input Port	HDMI, 3G SDI	/
Video Output Port	HDMI loop-out USB video out (to iOS)	HDMI 3G SDI
SDI Input Format	1080p: 23.98/24/25/29.97/30/ 50/59.94/60fps Level A/B 1080i: 50/59.94/60i	/
HDMI Input Format	4K (3840*2160) : 23.98/24/25/29.97/30/ 50/59.94/60p 1080p: 23.98/24/25/29.97/30/ 50/59.94/60p 1080i: 50/59.94/60i	/
SDI Output Format	/	1080p: 24/25/30/ 50/60p Level A
HDMI Output Format	/	4K (3840*2160) : 24/25/30/50/60p 1080p: 24/25/30/ 50/60p
HDMI Loop-Out Format	Identical to the HDMI video input	/
DC Port	5.5mmx2.1mm center positive	

DC Voltage	7.4~16.8V	
Battery	Compatible with NP-F550, NP-F750, NP-F970 battery	
Power Consumption ^[4]	6.5W average *Without powering other devices	5.0W average
Audio Input	HDMI embedded, SDI embedded	
Latency	1080p < 25ms ^[5] 4K < 35ms ^[6] (Camera latency excluded)	
Transmission Range	≥ 2.5 kilometers ^[7] (No obstacles, no interference)	
Operating Environment Temperature	-10~40°C	
Dimensions (Antennas Excluded)	130mm x 95mm x 32 mm	
Weight (Antennas Excluded)	322g	320g

[4] Measured when shooting 4K/60fps video under low bitrate.

[5] Measured when shooting 1080p/60fps video under low bitrate.

[6] Measured when shooting 4K/60fps video under low bitrate.

[7] Measured when shooting 1080p/60fps video with FCC compliance in an unobstructed, interference-free environment.

11 / FAQs

Receiver cannot connect to transmitter

1. Please make sure the transmitter and receiver(s) are set to the same group.
2. Please check that the antennas are securely mounted.

No video displayed

1. Please check whether the SDI/HDMI cable of the camera is correctly plugged into the corresponding port of the transmitter.
2. Please check if the video format and other information are shown on the display interface; if not, please check the cable and the SDI/HDMI video output of the camera.
3. Please check if the SDI/HDMI video format of the camera is compatible with the formats supported by the product.

Choppy video

1. Please check that the antennas are securely mounted.
2. Please make sure there are no metals or cables around the antennas that can cause signal blocking.
3. Please switch to another channel manually.

Mobile devices can't connect to the CineView Master 4K

1. CineView Master 4K has multiple Wi-Fi signals. Please confirm that the mobile device is connected to the 5GHz Wi-Fi, named "Accsoon_****".
2. Due to the different RF regulations in different countries/regions, please refer to 6.4 region setting to switch to the corresponding region according to your current location.

App fails to find the latest firmware

1. Please check if the Wi-Fi connection of your mobile devices can access the Internet properly.

2. Please check if the mobile devices have automatically connected to the CineView Master 4K's Wi-Fi signal. If so, please change to another Wi-Fi connection that can access the Internet properly and try again.

12 / Warranty

Warranty Period

1. If there is a quality problem that occurs within 15 days after receiving the product, Accsoon will provide complimentary maintenance or replacement.
2. Under proper use and maintenance, from the date of receipt, Accsoon will provide a one-year warranty on the wireless video transmission system and a three-month warranty on the accessories and cables. Free maintenance service is available during the warranty period.
3. Please keep the proof of purchase and the user manual in a safe place.

Warranty Exclusions

1. Out of warranty (If the proof of purchase is not available, the warranty will be calculated from the date the product is delivered from the factory).
2. Damage caused by use or maintenance is not following the requirements of the product manual.
3. Unauthorized repair, modification or disassembly.
4. Damage caused by force majeure such as fire, flood, lightning strike, etc..

13 / Warranty Process

1. Contact your local Accsoon authorized dealers for after-sales service. If there is no local authorized dealers, you can contact our customer service via our email (support@accsoon.com) or website (www.accsoon.com) and get appropriate support.
2. You will get detailed solutions from authorized dealers or Accsoon. Accsoon reserves the right to review the damaged product.

14 / Safety Information

1. When operating this equipment, read and follow all the instructions in this manual.
2. Use only accessories/batteries/chargers specified or recommended by Accsoon.
3. Do not expose to moisture, excessive heat or fire.
4. Keep away from water and other liquids.

15 / Contact Us

- 🌐 Website: accsoon.com
- 📘 Facebook: Accsoon
- 👥 Facebook Group: Accsoon Official User Group
- 📷 Instagram: [accsoontech](https://www.instagram.com/accsoontech)
- 📺 YouTube: ACCSOON
- ✉ Email: support@accsoon.com

Federal Communications Commission Interference

Statement

This equipment has been tested and found to comply with the limits for a Class B digital device, pursuant to Part 15 of the FCC Rules. These limits are designed to provide reasonable protection against harmful interference in a residential installation.

This equipment generates, uses and can radiate radio frequency energy and, if not installed and used in accordance with the instructions, may cause harmful interference to radio communications.

However, there is no guarantee that interference will not occur in a particular installation. If this equipment does cause harmful interference to radio or television reception, which can be determined by turning the equipment off and on, the user is encouraged to try to correct the interference by one or more of the following measures:

- Reorient or relocate the receiving antenna.
- Increase the separation between the equipment and receiver.
- Connect the equipment into an outlet on a circuit different from that to which the receiver is connected.
- Consult the dealer or an experienced radio/TV technician for help.

Certificate of Quality

This product is confirmed to meet quality standards and permitted for sale after strict inspection.

QC Inspector:



CineView **Master 4K**

Accsoon® is a trademark of Accsoon Technology Co., Ltd.

Copyright© 2024 Accsoon All rights reserved