



Contents

©2025 Fractal Audio Systems, LLC. All rights reserved. v1.0.1 – 2025-11-24

Welcome	4	Blocks Guide	24	Controllers > LFO (A/B)	45
Introducing the Setup Menu	4	The Amp Block: Amp Section	25	Controllers > Envelope Follower	46
AM4 in 60 Seconds	5	The Amp Block: Cab Section	26	Controllers > ADSR	46
Five Modes	5	Understanding CPU	28	Controllers > Sequencer	46
Footswitches and “Gig Mode”	6	Saving Changes	28	Controllers > Modifiers	46
The Home Page	7	Presets	29	Pitch Detector	46
Other Pages	7	Preset Tutorial	30	External Controllers	46
Top Panel	8	Input Gate	31	Firmware Updates	47
Back Panel	9	Main Levels	31	The Setup Menu	47
Expression Pedals	10	Preset EQ	31	SETUP > Audio	48
External Switches	11	Preset Mix/Routing	32	SETUP > Footswitches	49
Input Level	12	Bypass Mode	33	SETUP > Pedals	50
Output Level	13	Spillover	34	SETUP > MIDI/Remote	51
Output: Mono vs. Stereo	13	Reset Tools	35	SETUP > Global Settings	53
Tuner	14	Troubleshooting	35	SETUP > Reset	55
Tempo	14	Intro to Channels	36	SETUP > System Info	55
USB	15	Intro to Scenes	36	Specifications	56
AM4-Edit	16	Working With Scenes	37	Dimensions	57
Fractal-Bot	16	Scene MIDI	38	MIDI Implementation	58
Setup: Direct/FRFR	17	Scenes FAQ	39	MIDI PC# to AM4 Presets	59
Setup: Neutral Power Amp + Guitar Cab	18	Channels Tutorial	40	Warranty	60
Setup: Guitar Power Amp + Cab	19	Scenes Tutorial	40	EULA	61
Setup: Split Mode	20	Modifiers	41	Factory Preset Notes	62
Setup: SPDIF Input	21	Modifier Settings	42	Pre vs. Post Effects	65
Setup: SPDIF Output	21	Expert Modifier Settings	43	AM4 for Fractal Veterans	66
Setup: Using the Inserts	22	Modifier Tutorial: Wah	44	Levels Overview	67
Working With Blocks	23	The Controllers Menu	45	Audio and USB Signal Flow	68
Effect Blocks Inventory	24	Controllers > Tempo	45	Dimensions	69



- ▶ You can click links in this manual, including any entry in the table of contents.
- ▶ To return quickly to the table of contents, click “AM4 Owner’s Manual” in the upper left of most pages.

Declaration of Conformity

Manufacturer's Name: **Fractal Audio Systems, LLC**

Manufacturer's Address: **4 Wilder Drive, Plaistow, NH 03865 USA**

Declares that the product: Name: **AM4**; Option: **None**

Conforms to the following directives:

- ▶ Electromagnetic Compatibility(EMC) 2014/30/EU
- ▶ EN 55032:2015 AMD.1:2020+A11:2020
- ▶ EN 55035:2017+A11:2020
- ▶ EN IEC 61000-3-2:2019/A1:2021
- ▶ EN 61000-3-3:2013AMD.1:2019+ AMD.2:2021
- ▶ Low Voltage Directive(LVD) 2014/35/EU
- ▶ EN IEC 62368-1: 2020/A11:2020

Clifford Chase
President / CEO
September 16, 2025

Special Thanks

Special thanks to all who made this product possible including our beta team rock stars: MVP Brock Davisson, Knut Bausch, Ian Chesal, Mark Day, Dante Frisiello, Nick Kossup, Chris Luke, Joel McCreight, Zach Munowitz, Dylan Naegele, Tim Noonan, Rex Robitschek, Mark Severns, Paul Sidoti, Alexander Van Engelen, extraordinary interns Owen Case and Danny Schneider, and *The Magnificent AM4 Seven* factory preset team: Cooper Carter, Frank Steffen Mueller, Marco Fanton, Brett Kingman, Larry Mitchell, Buddy Gill, and Leon Todd.

Legal Notices

Fractal Audio Systems. AM4 Owner's Manual.

Contents Copyright © 2025. All Rights Reserved. No part of this publication may be reproduced in any form without the written permission of Fractal Audio Systems.

"Fractal Audio Systems", the Fractal Audio Systems logo, Axe-Fx, UltraRes, DynaCab, are trademarks of Fractal Audio Systems.

Manufacturer names and product names mentioned herein are trademarks or registered trademarks of their respective owners, which are in no way associated with or affiliated with Fractal Audio Systems. Names are used only to illustrate sonic or performance characteristics.

SAFETY



WARNING: To reduce the risk of fire or electric shock, do not expose this appliance to rain or moisture.



CAUTION: To reduce the risk of fire or shock, do not remove screws. No user serviceable parts inside. Refer servicing to qualified service personnel.

1. Obey all warnings on the product chassis and in this manual.
2. Keep away from sources of heat such as heat ducts, registers or appliances that produce heat.
3. Keep the AC Adapter in good condition. Do not kink, bend, or pinch power cords.
4. If the cord becomes damaged, discard and replace the adapter.
5. If not using your unit for extended periods of time, disconnect from power.
6. Refer servicing to qualified personnel only.
7. Stop operation of the unit and obtain service if:
 - Liquids or excessive moisture enter the unit.
 - The unit operates incorrectly, or performance is inconsistent or erratic.
 - The unit has been dropped and/or the enclosure damaged.
8. Prolonged exposure to high volume levels can cause hearing damage and/or loss. The use of hearing protection in high volume situations is recommended.



The AM4 is designed to be used only with the included 9V DC 1.5A negative center power supply or direct equivalent. Operating the unit using a supply with different specifications can cause problems including damage to your AM4 or other connected equipment.

EMC/EMI

This equipment has been tested and found to comply with the limits for a Class B Digital device, pursuant to part 15 of the FCC rules. These limits are designed to provide reasonable protection against harmful interference in residential installations. This equipment generates, uses and can radiate radio frequency energy and, if not installed and used in accordance with the instructions, may cause harmful interference to radio communications. There is no guarantee that interference will not occur in a particular installation. If this equipment does cause harmful interference, which can be determined by turning the equipment off and on, the user is encouraged to try to correct the interference by one or more of the following measures:

- Reorient or relocate the equipment or increase the separation between the devices.
- Connect the equipment to different outlets on different circuits.
- Consult the dealer or an experienced technician for help.

Welcome

Welcome to the AM4 Amp Modeler from Fractal Audio Systems. The AM4 delivers our industry-leading amp modeling, cab simulation, and effects from the award-winning Axe-Fx III, all in a streamlined, compact floor unit. It has a new easy-to-use interface inspired by our popular VP4 Virtual Pedalboard, and much more.

Industry-Leading Amp Modeling – The AM4 features Fractal Audio's latest amp modeling, recognized for accurate tone, dynamic feel, and continuous innovation. Rather than approximating an amp through artificial matching or capture, our approach models every critical component in the analog circuit—tubes, transformers, filters, even power supply—so the model responds and interacts just like the real amp at any setting—and even into creative sound design and beyond. We also continually refine our algorithms through improved techniques to deliver updates that will enhance the AM4 long after its release. This commitment has made our modeling the benchmark for professionals worldwide in both studio and stage applications.

Integrated Speaker Cab Simulation – The Amp block includes a built-in Cab Section without needing a separate block. Choose from 45+ **DynaCab™** models with visual mic positioning, or load your favorite impulse responses as **User Cabs** in UltraRes™ or standard formats. There's even a built-in stereo room sim—and more.

Four Amp/cab Channels – The Amp block provides four fully independent **channels**, allowing you to create and instantly switch among four complete amp-and-cab setups within a single preset, enhanced by our gapless switching technology. It's like having four premium amp pedals in one compact unit—without the cost or clutter.

Legendary Effects – The AM4 offers a curated selection of classic stompbox and studio effects powered by the acclaimed algorithms of the Axe-Fx III. With 77+ Drive pedal models, 75+ Reverbs, dozens of delays and 150+ options across Chorus, Compressor, Flanger, Phaser, Tremolo, Wah, EQ, Gate, Filter, and more, you can build complete polished tones. Connect the VP4 Virtual Pedalboard or add your favorite pedals for an unlimited sonic palette.

104 Presets, 4 Scenes Each – The AM4 provides 104 preset slots for you to load, customize or build your own complete rigs. Each preset can contain four blocks, with four scenes per preset and four channels per block—offering tremendous tonal flexibility. Factory presets can be edited or overwritten to suit your needs.

Four Footswitches, Five Modes – four onboard footswitches with five easy-to-use **modes** switch instantly between **Presets** or **Scenes**, toggle **effects and channels**, access **Tuner/Tempo**, or engage **Amp Mode** to select amp channels with a built-in **Output Boost**.

Uncompromising Sound Quality – True to our reputation, the AM4 has an audiophile quality signal path with the clarity, depth, and range for professional live and studio use.

Expression Pedal Support – Connect up to two external expression pedals or switches for real-time control. Fractal Audio EV pedals are perfect for the AM4.

Pro-Grade I/O – A low-noise instrument input with **Auto-Z** automatically adjusts impedance to accurately load your guitar's pickups—such as when vintage-style effects appear first in the chain. Balanced **TRS outs** provide clean, quiet, flexible connections to FRFRs, mixers, or interfaces. A **stereo insert** allows you to integrate external effects or processors after the AM4 without compromising the balanced outputs. S/PDIF in and out allow digital interconnection. A dedicated **headphone out** provides high-quality silent monitoring.

4x4 USB Audio – Record the processed outputs, play computer audio at the main outs, capture a DI, or play back computer audio through the AM4 for processing or re-amping.

AM4-Edit Software – Our free editor and librarian makes it easy to create, organize, and manage presets, scenes, cabs, and more from a Mac or PC.

Upgradeable Firmware – True to Fractal Audio's commitment to continual improvement, the AM4 supports firmware updates for new features, enhancements, models, and more.

Introducing the Setup Menu

The Setup menu helps you make the most of the AM4.

It contains various global settings, options, utilities, and info, with pages for **Audio, Footswitches, Pedals, MIDI/Remote, Settings, Reset, and System Info**.

A detailed guide to every option in the Setup menu begins on [p. 47](#).

OPEN THE SETUP MENU

- ▶ Press **ENTER** and **EXIT** together.
- ▶ Use **PAGE LEFT** and **PAGE RIGHT** to navigate the menu.
- ▶ Press **EXIT** to go back to wherever you came from.



 Changes in SETUP are stored automatically as you make them. When this happens, the title bar of the AM4 will display **"SAVING..."**. Do not turn the power off while the AM4 is saving, or your most recent changes could be lost.

AM4 in 60 Seconds

CONNECT THE AM4

The following describes a typical amp modeling setup in mono or stereo. Additional setup options begin on [p. 17](#).

- Power off all equipment and turn down all volume controls.
- Connect the supplied 9V 1.5A AC adapter—or a direct equivalent—to the AM4.
- Connect your guitar to the AM4 Instrument In using an instrument cable.
- Connect Out 1 L/Mono to your FRFR, mixer, or audio interface. For stereo, also connect Out 1 R to a second speaker or channel. Use balanced cables for balanced inputs; use standard patch cables otherwise.
- Power on your system (turning on speakers last). Raise volume controls slowly, using the AM4 top-panel Level knob to set the desired output level.

PLAY PRESETS

- ▶ Place the AM4 into **Preset Mode** (green LEDs). (See inset right). Use the footswitches to load **presets**. Press and hold **Switch 1** or **Switch 4** to change **banks**.

EDIT BLOCKS

See [p. 23](#) for more on Editing.

- ▶ To change **Block Type** (Amp, Drive, Delay, Reverb, etc.) turn **SELECT** to highlight any block on the Home page, turn **ABC D** to the desired type and then press **ENTER**.
- ▶ To edit a block, select it and press **ENTER**.
- ▶ On Block Edit pages, turn **A,B,C,D**, and **SELECT** to make changes.
- ▶ Use **◀ PAGE ▶** buttons to access more pages. The leftmost page lets you choose models or types within the block, and change channels.
- ▶ Save changes if you want to retain them (see below, right).

AMP MODE

See [p. 25](#) for more on the Amp block

- ▶ Press **footswitches 2 + 3** together to enter or exit **Amp Mode**.
- ▶ Footswitches select amp channels; tap the active channel to toggle Boost.
- ▶ The Amp Edit menu stays on screen, with all settings for the current channel.
- ▶ Use **PAGE** for more settings, including **Amp GEQ**, plus **Cab and Mic** settings, Main/Boost levels, and a handy VU meter for leveling.
- ▶ The leftmost page lets you select the **amp model** and set the footswitch color for the current Amp Mode channel.

Five Modes

There are five footswitch modes: Presets, Scenes, Effects, Tune/Tempo, and Amp Mode. Each mode provides its own set of footswitch functions.

Press footswitches 1 + 2 together to enter **MODE SELECT**. (See also next page.)

SELECT A MODE

Use **MODE SELECT** to change the mode. To access Mode Select:

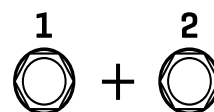

Press switches 1+2 together.



Press HOME+SAVE buttons together.

In Mode Select, use the footswitches to choose a mode:



On the **Home** page the mode changes automatically as you turn **SELECT** to highlight the **Preset** name, **Scene** name, or one of the **Blocks**.

Shortcuts

- Press 1 + 2 at any time to jump instantly to Mode Select.
- Press 2 + 3 at any time to jump instantly to Amp Mode.
- Press 3 + 4 at any time to jump instantly to Tune/Tempo Mode.

SAVE CHANGES

See [p. 28](#) for more on Saving

- ▶ To save changes to the current preset, press **SAVE** then **ENTER**.
- ▶ Use **SELECT** and **ABCD** to choose a location to save to. Edit the preset name and scene names if desired. Press **ENTER** 2x to confirm.

Footswitches and “Gig Mode”

The AM4 includes a master footswitch setup called Gig Mode. Enabled by default, it provides access to Amp Mode, Preset Mode, Scene Mode, Effects Mode, and Tuner/Tempo Mode, with additional functions available by press-and-hold. Unlike the five standard operating modes, Gig Mode serves as an overall control layer for them all.

UNIVERSAL SHORTCUTS

Tap these two-switch combos for quick access to essentials.

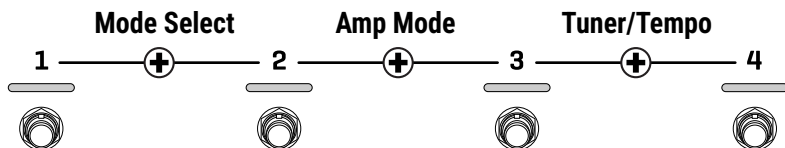

PRESET MODE

Tap to load a Preset from the current Bank.



SCENE MODE

▼ TAP any switch to load a Scene from the current Preset.

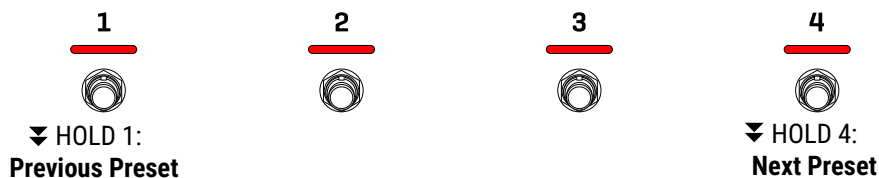

AMP MODE

▼ TAP any switch to load a Channel in the Amp block

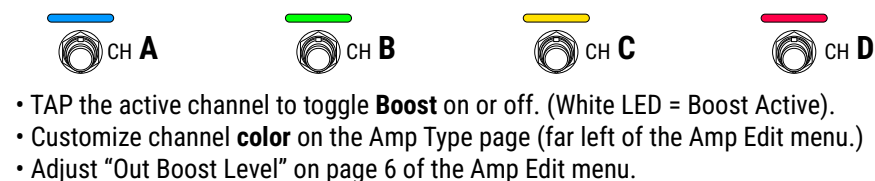

EFFECTS MODE

▼ TAP a switch to bypass or engage the effect. The **Amp** switch toggles Boost instead.



TUNER + TAP TEMPO MODE

▼ TAP Switch 1 for **Tempo**, Switch 3 to toggle **MUTE**, and switch 4 to **Exit** the tuner.

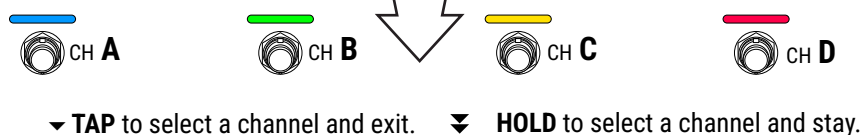

*NOTE: In Gig Mode, most footswitches trigger on release rather than on press because of the press-and-hold and “combo” settings. You can disable Gig Mode or choose custom options under **SETUP > Footswitches > Press and Hold Mode**, but doing so removes access to Gig Mode’s special functions.*

NOTE: You can change amp channels by holding the Amp block footswitch in Effects Mode, but this isn’t the same as entering Amp Mode (above, right). Amp Mode also gives you easy boost, instant access to amp settings, and persistent channel selection on Tap instead of Hold.

The Home Page

The home page is designed to help you set up the AM4 and use when playing or performing.

The AM4 contains 104 **PRESETS**.

Presets are grouped in **BANKS** (A-Z) containing four presets each.

See [p. 29](#) for more about presets.

Each preset also contains four **SCENES**.

• Scenes are a power user feature that can reduce the need to “tap dance” on Footswitches—and much more. See [p. 36](#) for more about Scenes.

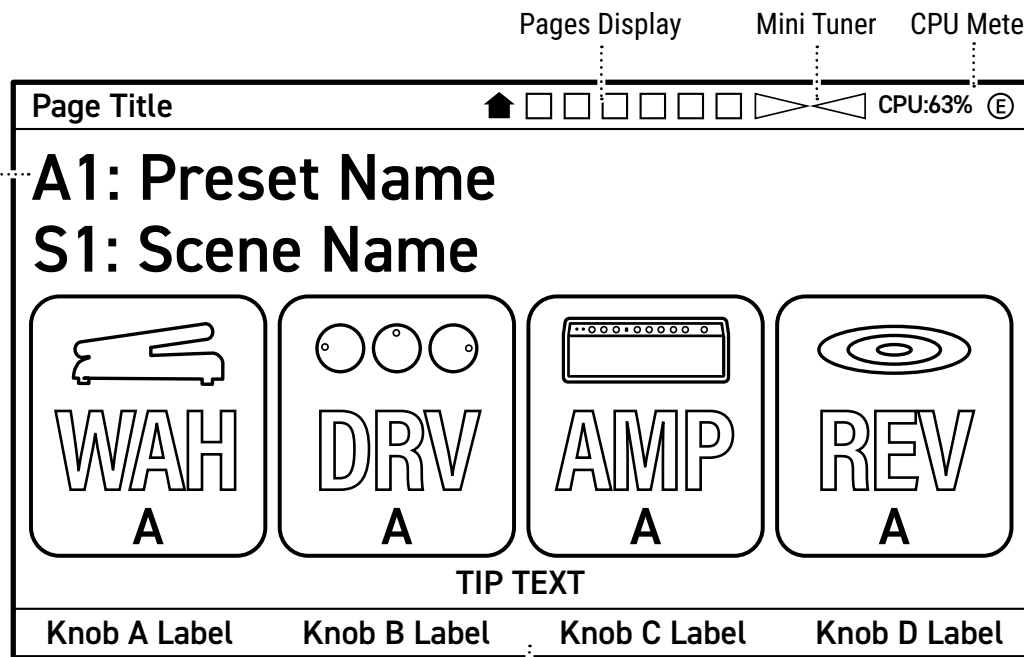

“Edited” **E** appears here whenever there are unsaved changes to the current preset.

Each preset can have four blocks. The centerpiece is the Amp block, but you’ll also find Effects including Drives, Delays, Reverbs, Modulation FX, EQs, and many more.

See [p. 23](#) for more.

The letter beneath each effect indicates its current Channel.

• Channels add significant flexibility to a single preset. They are also essential to how **Amp Mode** works.

• See [p. 58](#) for more.

Labels show the functions of ABCD knobs on many pages.

Other Pages

The different areas of the AM4 use different types of pages containing various settings and options. Use the **ABCD** and **Select** knobs to navigate these pages and make changes.

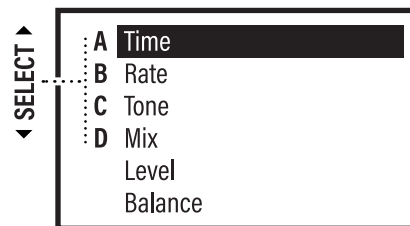
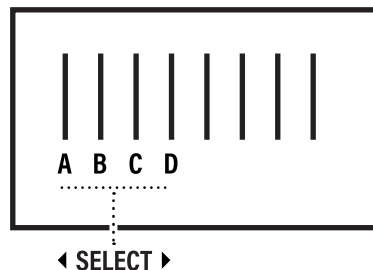
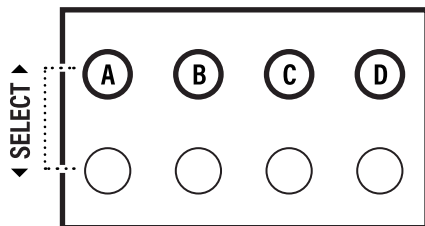

	A	B	C
Time	Time	Time	Time
Rate	Rate	Rate	Rate
Tone	Tone	Tone	Tone
Mix	Mix	Mix	Mix
Level	Level	Level	Level
Balance	Balance	Balance	Balance

Top Panel

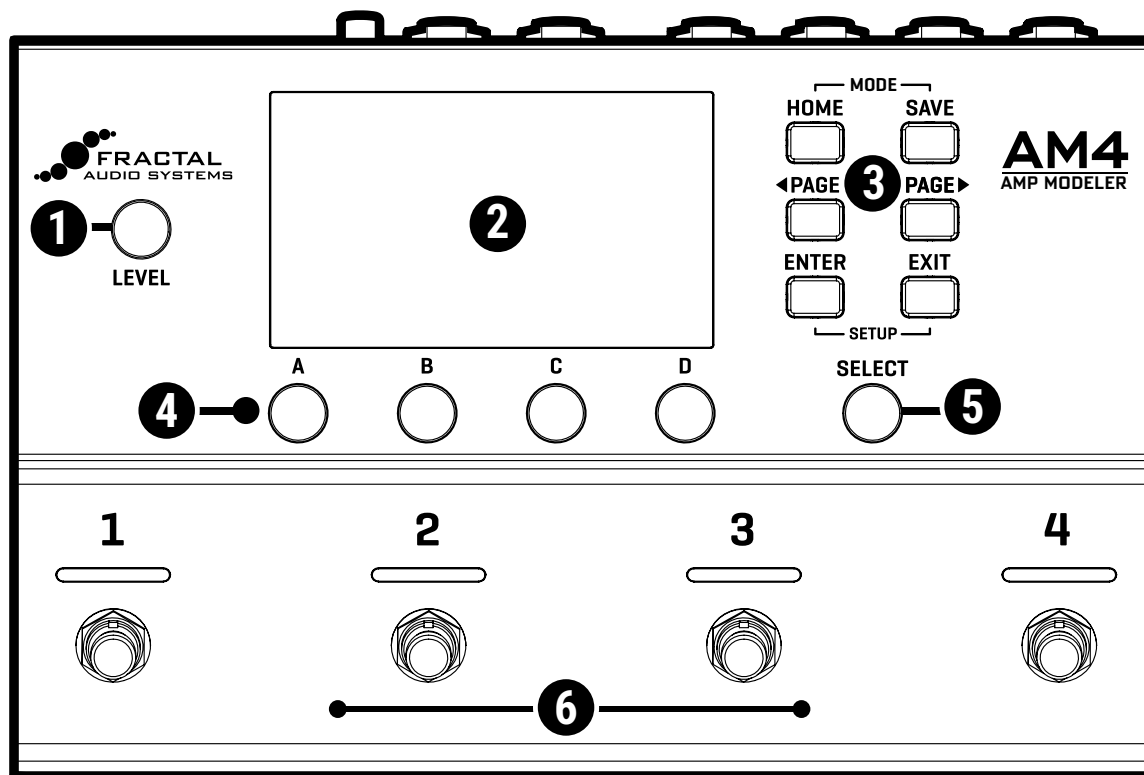

1 LEVEL – The top panel **LEVEL** knob controls the analog output level at the main outs and the headphones jack.

2 DISPLAY – The display is a high contrast color LCD.

3 BUTTONS – Six buttons operate the AM4:

- **HOME**: Press this to show the Home page at any time.
- **SAVE**: Press this to save the current Preset. See [p. 28](#).
- **◀ PAGE LEFT** and **PAGE RIGHT ▶**: Use these to navigate left and right through any menu. Icons in the title bar show where you are. 🏠 □ □ □ □ □
- **ENTER, EXIT**: These confirm or cancel various options, and also perform special actions. Some pages show tips. For example, with an Effect block selected on the Home page, you will see, “ENTER = Edit Selected Effect”. **ENTER** is also used to add a Modifier for remote control or realtime parameter changes. Learn more beginning on [p. 41](#).

4 ABCD knobs – Turn the knobs to adjust on-screen settings. In a vertical menu or grid, look for labels that show how the knobs map to controls.

5 SELECT knob: Highlights different areas of the current page. For instance, if the page displays multiple rows of controls, turning the SELECT knob will switch between the rows. Once a row is highlighted, use the ABCD knobs to adjust the controls in the selected row.

NOTE: On the **HOME** page, **SELECT** also changes the **Mode** between Preset, Scene, and Effects.

6 Footswitches – Four footswitches use our proprietary Solid State Switching (SSS™) technology, ensuring smooth, quiet operation with no mechanical contacts to fail. Their default functions vary based on the current **Mode**.

i Note: The default “Press and Hold” options cause the footswitches to fire when you release instead of when you tap. You can disable or customize press and hold using **SETUP > Footswitches**. See [p. 49](#) for more on this.

BUTTON COMBOS

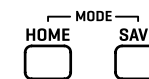

HOME + SAVE: Press at the same time to show **MODE SELECT**.



ENTER + EXIT: Press at the same time to show the **SETUP** menu. See [p. 4](#) for an intro.

Back Panel

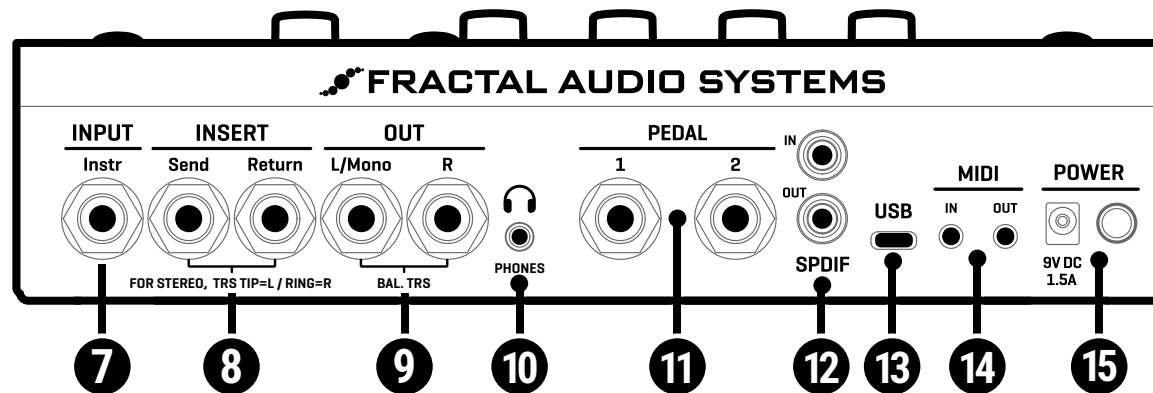

- 7 INPUT** – Connect your guitar, bass or other instrument to the **Instrument Input** using an instrument cable. You can also connect the outs of guitar pedals or other instrument level signals.
- 8 INSERTS** – These jacks provide a fixed insert point between the AM4's internal effects and its balanced outputs. Use them to connect external gear while preserving the clean, low-noise performance of the balanced outputs. For mono, use a standard patch cable. For stereo, use a TRS-to-dual-mono insert cable (tip = left, ring = right).
- NOTE:** The insert is fixed in hardware and cannot be repositioned or switched on/off. It is not heard on USB or S/PDIF.
- 9 OUTPUTS** – Two balanced 1/4" outputs for connecting to FRFR speakers, mixers, audio interfaces, power amp/return, etc. For balanced connections, use TRS-to-XLR or TRS-to-TRS cables as appropriate. For unbalanced connections, use standard patch cables. The AM4 does not require or support the use of Humbuster™ cables. Because it is an amp modeler, the AM4 outs operate at adjustable line level rather than fixed unity gain.
- Output Levels:** Out levels depend on the settings within your Presets, Scenes, and Effects, and are also controlled by the top panel **LEVEL** knob. If output clipping occurs, an **OUT CLIP** warning is displayed. See [p. 13](#) for more.
- Mono vs. Stereo:** The AM4 defaults to stereo output, which is also compatible with mono, but other options are available. See [p. 13](#) for more.
- 10 Headphone** – A 3.5 mm stereo jack for headphones. 35Ω output impedance. Recommended headphone impedance < 600 Ω.
- 11 PEDAL jacks** – The AM4 has two jacks for connecting expression pedals like the Fractal Audio EV series. Alternatively, a single momentary or latching switch can be connected in place of an expression pedal. When you first connect a pedal or switch, it needs to be configured. Learn more starting on [p. 10](#).
- 12 SPDIF DIGITAL I/O** – Digital interconnection for SPDIF devices. The AM4 runs at a fixed sample rate of 48 kHz. To use the SPDIF input, you must first select it manually in **SETUP > Input Source**. See [p. 21](#)
- 13 USB** – The AM4 is also a high quality, 484, 24-bit/48kHz audio interface for Mac and Windows computers, with added MIDI-over-USB capability for connecting to AM4-Edit, Fractal-Bot, or any DAW or computer MIDI application. See USB on [p. 15](#) for more.
- 14 MIDI** – The AM4 features 3.5 mm MIDI In and Out ports for modern, space-saving connectivity. To connect to traditional 5-pin MIDI hardware, a "Type A" 3.5 mm to 5-pin DIN adapter is required. These are available at shop.fractalaudio.com. The optional **SETUP > MIDI/Remote > MIDI Thru** setting can be enabled to echo messages from In to Out. A detailed MIDI implementation can be found on [p. 58](#).
- 15 POWER** – Connect only the included 9V DC 1.5A negative center power supply or direct equivalent. Operating the unit using a supply with different specifications can cause problems including damage to your AM4 or other connected equipment. The AM4 features pop suppression, but amps/speakers in a rig should always be turned off first and on last.

Expression Pedals

The AM4 has two jacks for connecting external expression pedals or switches. Each jack can host one pedal or one switch. **Pedals** allow realtime control of effects like wah, volume, and many more, and they can also be assigned to global volume options. **Switches** can similarly be used to control effects, and can also be assigned to global options including Tempo, Bypass, and more.

EXPRESSION PEDAL

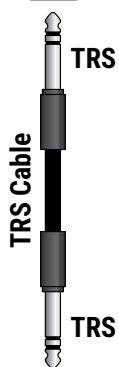

PEDAL JACK 1 or 2

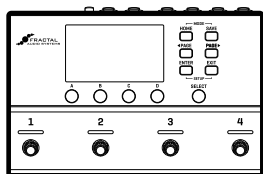

CONNECT & CALIBRATE A PEDAL

Expression pedals should have a linear resistance taper and must have a maximum resistance in the range of 10–100kΩ. Expression pedals must be used with Tip-Ring-Sleeve (TRS) cables.

1. Connect an **expression pedal** to one of the AM4 Pedal jacks using a **TRS-to-TRS** cable.
2. Open **SETUP > Pedals**.
3. For pedal jack 1, set **Pedal 1 Type** to "EXPRESSION PEDAL".
For pedal jack 2, use **Pedal 2 Type**.
4. Select the **Calibrate** option and press **ENTER**.
5. Follow the on-screen instructions to perform Calibration.
6. Check your pedal by sweeping it through the entire range and watching the on screen meter.
7. Press **HOME** when finished.

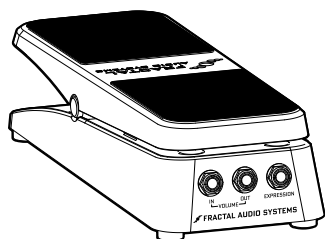

FRACTAL AUDIO EV PEDALS

The Fractal Audio EV pedals are perfect for use with the AM4. They deliver smooth, linear control and are built tough. EV Pedals double as analog volume pedals, offering versatility for different setups.

ASSIGN A PEDAL FOR EFFECT CONTROL

Expression pedals can be used to control sound settings using a **Modifier** with its **SOURCE** set to "PEDAL 1" or "PEDAL 2". Modifiers are saved with the preset rather than operating globally. Typical uses include controlling wah, whammy, or volume but there are countless possibilities. Learn more starting on [p. 41](#).

ASSIGN A PEDAL FOR GLOBAL VOLUME

Pedals can also be assigned globally to **Input Volume** or **Output Volume**, eliminating the need to add a Volume effect block in every preset.

1. Open **SETUP > MIDI/Remote**.
2. Turn **SELECT** to **Input Volume** or **Output Volume**.
3. Turn **Knob A** to set the value to "PEDAL 1" or "PEDAL 2".
4. Press **HOME** when finished.

TUNER ON HEEL DOWN

The AM4 can automatically show the tuner when a connected pedal, switch, or MIDI controller is in the low position ("heel down").

1. Open **SETUP > MIDI/Remote**.
2. Turn **SELECT** to **Tuner on Heel Down**.
3. Turn **Knob A** to set the value to "PEDAL 1" or "PEDAL 2".
4. Press **HOME** when finished.

FAQ: Expression Pedals & Factory Presets

Some AM4 Factory Presets use expression pedals with "Auto Engage," a feature that engages the effect when you move the pedal. This **disables** the footswitch that normally turns the effect on or off. Auto-Engage is a feature of the "Modifier" system. Learn more starting on [p. 41](#)

External Switches

Each of the AM4 pedal jacks can be used to connect a single switch instead. Switches provide on/off simplicity to control sound parameters or global settings.

Connect a single switch to one of the AM4 Pedal jacks using a patch cable.

For a dual switch, connect to **both** pedal jacks of the AM4 using a TRS "insert" cable.

SET UP A SWITCH

1. Connect your switch(es) as shown (left).
2. Open **SETUP > Pedals**.
3. For the "Pedal 1", set **Pedal 1 Type** to the appropriate "SWITCH" option:
 - Choose "SWITCH (Any, Follow Hardware)" when you connect either a latching/toggle switch, or when you connect a momentary switch and want it to work as a momentary switch.
 - Choose "SWITCH (Momentary, Virtual Toggle)" when you connect a momentary switch but want it to work as a latching/toggle switch.
4. Press **HOME** when finished.

FAQ: Momentary/Latching

Switches are available in two formats: momentary and toggle/latching. Momentary switches stay active only while being pressed, like a piano sustain pedal. Toggle/latching switches remain engaged until you click them again, like a classic stompbox.

Either type can be used with the AM4, but momentary switches are more flexible because they can be also used to create "Virtual Toggle" switches with tap on/tap off action.

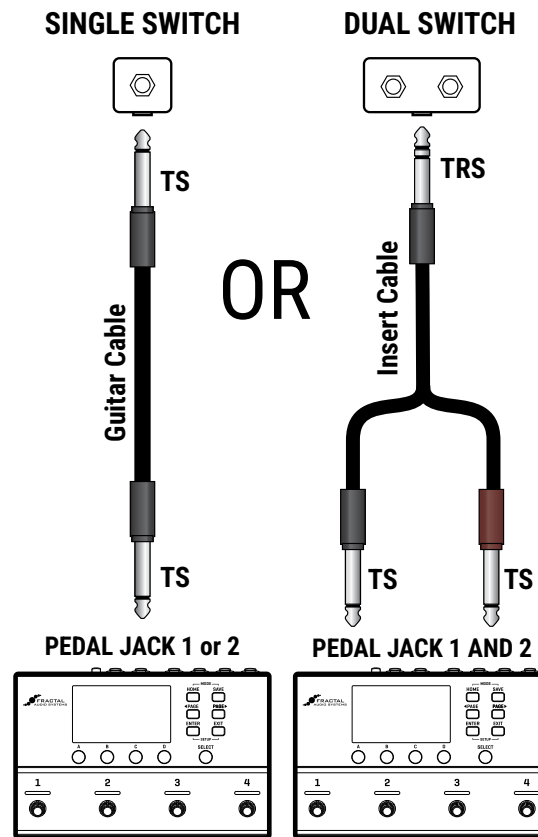

ASSIGN A SWITCH FOR EFFECT CONTROL

External Switches can be used to control sound settings using a **Modifier** with its **SOURCE** set to "PEDAL 1" or "PEDAL 2". Modifiers are saved with the preset rather than working globally. Typical uses include controlling delay hold, rotary speed, or drive level, but there are countless creative possibilities. Learn more starting on [p. 41](#).

ASSIGN A SWITCH TO A GLOBAL FUNCTION

External Switches can be assigned to global Input or Output volume as a "Kill Switch," or to "Tap Tempo" or "AM4 Bypass".

1. Open **SETUP > MIDI/Remote**.
2. Turn **SELECT** to the desired option.
3. Turn **Knob A** to select "PEDAL 1" or "PEDAL 2".
4. Press **HOME** when finished.

Input Level

The AM4 features an adjustable input pad that allows it to accept signals ranging from very quiet vintage guitars to loud pedals or processors.

The **Input Pad** setting can be adjusted from 0 dB (for low-level input signals) to 6 dB, 12 dB, or 18 dB (for progressively louder input signals). The default Input Pad setting is 12 dB, which is well suited for guitars with hot pickups.

When the input clips, a red **"IN CLIP"** warning appears in the title bar, indicating the need to increase the Input Pad setting.

IMPORTANT: *You will not hear any difference in level as you adjust the Input Pad. The AM4 adds compensation so your guitar is processed at the same level it would be when connected directly to an analog amp or pedal.*

Automatic Input Pad Adjustment

If the input of the AM4 clips persistently, the unit will automatically increase the Input Pad setting. When this occurs, the word "Auto" will appear next to the Input Pad value, for example: "12 dB (Auto)", indicating that the pad was automatically increased to 12 dB. When you reboot the AM4, the automatic setting is cleared, and the last manually selected value is restored. If you want to make the automatic pad setting permanent, just turn the **Input Pad** knob one "click" to clear "Auto".

ADJUST THE INPUT PAD:

- ▶ Open **SETUP > Audio > Input Pad**.
- ▶ Play loudly and watch the meter. If clipping occurs, the input meter will turn red and **"IN CLIP"** will appear in the title bar.
- ▶ Increase the **Input Pad** setting as high as necessary to prevent clipping.

 *If clipping still occurs with the Pad set to its maximum 18 dB, reduce the signal level before it reaches the AM4. This might mean lowering the output of your instrument, turning down a boost or drive pedal, or using a passive attenuator. The goal is to ensure the AM4 receives a clean, strong signal without exceeding its input headroom.*

FAQ: Why not just leave Input Pad all the way up?

Because the Input Pad isn't a "better safe than sorry" control—it's a precision tool.

The AM4's modeling lets you create high-gain tones at any level, allowing you to explore settings that would be window-breakingly loud on a traditional amp. You don't need to max the Pad to stay safe or sound powerful.

Technically, a pad at the converter's input requires a corresponding boost at its output to maintain unity gain—ensuring your guitar signal reaches the amp modeling stage at the correct level for accurate, realistic tone. While this keeps the overall level consistent, it also raises the noise floor—the quiet background hiss present in every audio circuit. In most cases this noise is minimal, but with high-gain amp models even a small increase can become noticeable.

For the cleanest signal and best signal-to-noise ratio, set the Input Pad as low as possible while still preventing clipping. If noise becomes a problem, use the built-in Input Gate found in every preset, or try an extra Gate block for creative control.

Output Level

The AM4 has two stages that affect your overall volume: **internal levels**, set within your presets, and **analog levels**, controlled by the top-panel knob. Understanding the difference helps you make the most of the unit. Remember to check levels under different conditions, especially if certain presets, scenes, or effects run loud, or when using the amp boost.

i Because it is an amp modeler, the AM4 outputs operate at adjustable line level rather than fixed unity gain.

Internal Levels

INTERNAL LEVELS are determined by the combined amp settings, effect settings, and level settings within your presets. You can edit blocks individually, or open the **Preset Mix/Routing** page of the Home menu to adjust all four block levels in one place.

Every preset also includes a master **Preset Level** and four **Scene levels** on the **Main Levels** page of the Home menu.

The **Input Gate** also has a **Level** control which is applied prior to all effects.

The Internal Levels Meter—found on the **Main Levels** of the home menu page and repeated on the 2nd to last page of the **Amp Edit menu**—shows a white line at 0 dB, the “sweet spot” where levels are strong but still have plenty of headroom. It’s fine to push slightly past 0 dB, but avoid hitting the ceiling. Higher internal levels can also make it easier to clip the analog outputs (see below).

Analog Levels

ANALOG LEVELS are controlled by the top-panel **OUT LEVEL** knob, which sets the volume of the analog outputs and headphones. Use it to set your preferred listening level, but avoid overdriving the output stage or your connected device(s). The Analog Levels meter on the **Main Levels** page shows how close you are to clipping, and an **OUT CLIP** warning will also appear in the title bar across all pages if clipping occurs. If this happens, lower the knob or reduce levels inside your presets.

Of course, your speakers, mixers, or recording interface have their own volume or gain controls as well. These operate after the AM4 outputs, so you can keep the AM4 hot and adjust downstream, or vice versa.

Output: Mono vs. Stereo

The AM4 defaults to “**STEREO**” output mode. This setting is also compatible with mono setups, but several other options are available under **SETUP > Audio > Output Mode**. Here is an overview of several scenarios, with recommended settings for each.

- ▶ **Stereo:** *No special settings required. Connect the AM4 outputs to two amps or to the dual inputs of stereo pedals or processors.*
- ▶ **“Half Stereo”:** Leave the AM4 in its default stereo configuration but connect only the left output to a mono input for a “half-stereo” setup. You may find that certain sound settings produce unique half-stereo results. For example, a “panner” will sound like a tremolo when one side is missing. A ping-pong delay will “ping” but never “pong.” Compare “**SUM L+R**” below.
- ▶ **Copy L > R:** If you want to force your rig to mono, “dual mono” is also an option. Sonically, this is identical to using the left channel in half-stereo (above), except that the mono signal is output at *both* the left and right jacks for use with two mono amps. To switch to dual mono, change **SETUP > Audio Output Mode** to “**COPY L- > R**”.
- ▶ **SUM L+R:** In this mode, left and right channels are internally combined into a “summed mono” signal that is sent to both left and right outputs. This has the advantage of not discarding half of the sound, but certain stereo signals can be problematic when summed to mono. For example, short delays or phase differences between channels can result in strange artifacts or even total cancellation. Take the “2290” style delay. Like the effect it is based on, the right channel of the wet signal is phase inverted, so the effect is silent when summed to mono! To switch to summed mono, change **SETUP > Audio Output Mode** to “**SUM L+R**”. (In addition to “2290 w/Modulation” this applies to Warm Stereo Delay, 80s Style Chorus, Triangle Chorus, Warm Stereo Chorus, and various other effects.)
- ▶ **SPLIT:** In Split Mode, the AM4 uses an automatic routing configuration that sends the full amp-and-cab sound to one side and a “no-cab” signal to the other. Each output operates in summed mono. See [p. 20](#).

Tuner

The AM4 offers a precise tuner with a bar graph, arrows for flat or sharp, and a virtual strobe that rotates clockwise for sharp and counterclockwise for flat. In the default "Gig Mode" there are multiple ways to show the tuner:

- ▶ Press **Footswitches 1 + 2** simultaneously and then select Tuner (4).
- ▶ Press **Footswitches 3 + 4** simultaneously.

The tuner includes an optional **mute** on footswitch 3. You can set this to come on automatically using the tuner **Mute Type** options detailed below.

Exit the tuner the same way you opened it or simply select another mode.

 **TIP:** Most pages also include a "Mini Tuner" in the title bar.

Tuner Options

From the tuner, you can press PAGE RIGHT to show the global tuner options:

PARAMETER	Description.
Mute Type Auto In Auto Out Manual In Manual Out	"Auto" options engage the mute every time the tuner is opened. You can un-mute and re-mute manually using footswitch 3. "Manual" options require you to tap footswitch 3 to mute the tuner. Both "In" options mute at the input. Tails ring out. Both "Out" options mute at the output. Tails are silenced.
Display Mode MIXED/FLATS/SHARPS	Determines whether the tuner shows note names for accidentals as Sharps, Flats, or a mix of both.
Calibration	Calibrates the tuner. The tuner defaults to A440.
Downtune 0 – 4 Semitones	The Downtune control makes tuning feel more familiar when your guitar is tuned down. For example, if your guitar is tuned down half a step to Eb, setting Downtune to "1" will show the notes in the tuner as if the guitar were in standard E tuning.
Use Offsets OFF/ON 1st, 2nd, 3rd, etc.	Use Offsets determines whether the six offset settings are applied or ignored. Offsets allow the tuner to adjust individual notes slightly away from standard tuning. This is useful for specific tuning systems like Buzz Feiten tuning. The offset range is +/- 25 cents.

Tempo

In Tuner mode, **Footswitch 1** functions as **Tap Tempo**, letting you set the AM4's global tempo. You can also adjust tempo using **Knob A** on the tuner.

USING THE TEMPO

Many effect settings can sync to tempo, including delay time, tremolo speed, sequencer steps, and many more. Tempo sync isn't global—it must be enabled per parameter, per effect, in each preset.

Tempo-based parameters appear as a separate option alongside the setting they control. For example, in the Digital Mono Delay, you'll see both a Time control and a corresponding Tempo control.

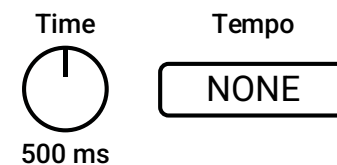

When Tempo is set to a rhythmic value, the corresponding time or rate control becomes inactive. Its current value appears in parentheses, and a warning is shown if you attempt to change it.

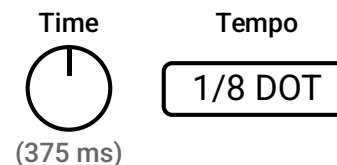

Tempo to Use

Each preset also includes a setting that determines whether its stored tempo becomes active when the preset is loaded.

See **Controllers > Tempo: "Tempo to Use"** on [p. 45](#) for more.

USB

USB provides the AM4 with a host of great audio features. With 4×4 channels, you can record the AM4's outputs or its input, play back computer audio at the outputs of the AM4, or send computer audio to the AM4 for processing.

USB COMPUTER INPUTS (RECORDING)

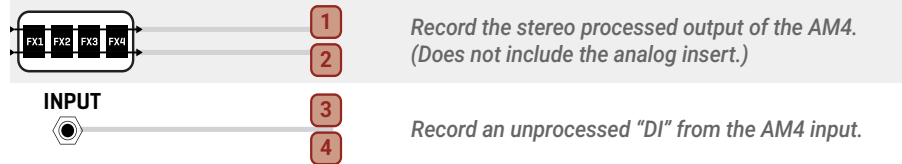

USB COMPUTER OUTPUTS (PLAYBACK)

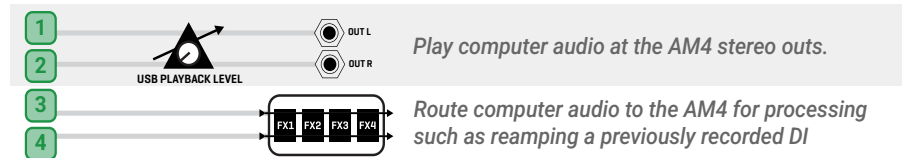

FAQ: Why would USB cause noise or hum?

A ground loop can occur when your computer, powered speakers, and AM4 are connected simultaneously. To prevent or eliminate hum, try one or more of the following:

- If you're using a laptop, try switching between AC power and **battery power** to see which is quieter.
- **Balanced cables** can also reduce noise.
- Insert a **USB Ground Loop Eliminator** (Type-C > Type-C) between the AM4 and the computer.
- Try an audio **isolation transformer** between the AM4 and any AC-powered speakers, mixer, or amplifier.

macOS Minimum Requirements

- **OS:** macOS 10.13 High Sierra or newer. (Earlier versions may work but are not supported.)
- **CPU:** Intel processor or Apple Silicon.
- **Memory:** 2 GB minimum (4 GB or more recommended).
- **USB:** USB 2.0 support required. No driver is required for macOS.

Windows Minimum Requirements

- **OS:** Windows 11 (64-bit).
- **CPU:** 1 GHz or faster with 2 or more cores on a compatible 64-bit processor or System on a Chip (SoC) – Intel Core i3 (8th Gen) or AMD Ryzen 2000 series or newer.
- **Memory:** 4 GB minimum (8 GB recommended).
- **Storage:** 64 GB of available space recommended for installation and updates.
- **USB 2.0** support required. A **driver** is required on Windows. Download the latest version from: www.fractalaudio.com/AM4-downloads.

AM4-Edit

AM4-Edit is a free, intuitive software editor for the AM4. This app lets you easily create, edit, and manage the AM4 from your connected Mac or PC, providing a fast and user-friendly interface. Whether you're dialing in effects, building scenes, or managing presets, AM4-Edit simplifies the process, helping you get the most out of your unit. It even includes bonus features not available on the AM4 itself, such as Block Library, Channel Copy, Scene Swap, and more.

You can download AM4-Edit for Mac or Windows at:
<https://www.fractalaudio.com/AM4-edit>

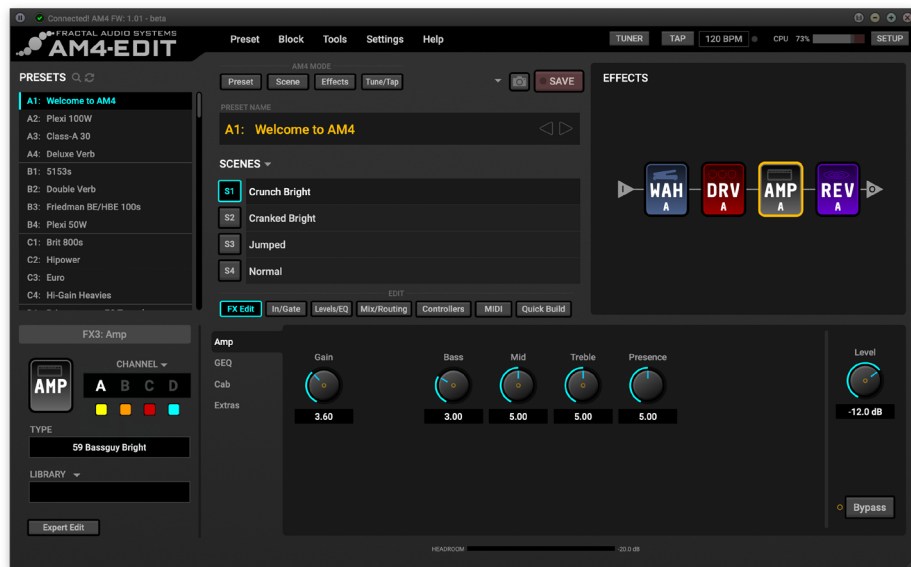

Fractal-Bot

In the Tools menu of AM4-Edit, you'll find **Fractal-Bot**, a companion utility for updating firmware, installing presets and cabs, and managing backups of your AM4. It features a simple, self-guided interface that's quick and reliable.

When a new firmware version becomes available, open AM4-Edit, launch Fractal-Bot from the Tools menu, and follow the on-screen instructions.

Backing up your AM4 is easy with **Receive Mode**. It's a good idea to make backups before any firmware update or whenever you make major changes to your sounds or settings.

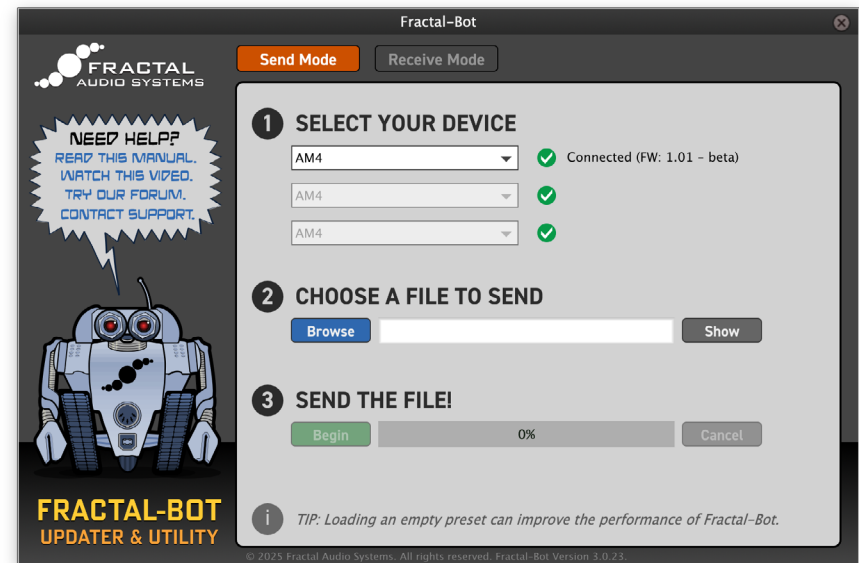

Setup: Direct/FRFR

Most players will use the AM4 **direct** into full-range powered speakers, a mixer, or an audio interface. This setup delivers the complete modeled amp, cab, and effects signal chain—ideal for the full AM4 experience.

FRFR (Full-Range, Flat-Response) systems aim to reproduce your sound accurately across the full frequency range, reproducing the tone and feel of the modeled amp and cab. Common examples include powered PA speakers, studio monitors, and dedicated FRFR guitar cabinets. These may be self-powered (“active”) or driven by a separate full-range amplifier.

If you're connecting to a mixer or audio interface, use line-level inputs, not microphone inputs or preamps. Contact the manufacturer of your mixer or interface if you're unsure.

Almost all AM4 factory presets are optimized for direct FRFR or line-level use, with no special global settings required.

This configuration is also ideal when recording with a computer or DAW via USB. In this case, your connected FRFR speakers or monitors will serve as the main playback system.

FRFR = “Full Range, Flat Response”

FRFR stands for “Full-Range, Flat Response,” used to describe a system which aims to reproduce the entire audio spectrum without compromise. In comparison, most traditional guitar speakers have limited range -- they cannot reproduce extended lows and highs -- and are not at all “flat” -- meaning some frequencies are markedly louder or quieter. Full-range flat response studio monitors, high-quality PA speakers, and FRFR speakers designed specifically for guitar should be able to reproduce anything you send to them. Of course, even these may vary, depending on which brand and model you choose.

SETTING UP

- ▶ Power off all gear before making connections.
- ▶ Connect your instrument to the AM4 Input using an instrument cable.
- ▶ Connect the AM4 outputs to your system:
 - For mono, use Out 1 L/Mono into your FRFR, mixer, or interface.
 - For stereo, also connect Out 1 R.
 - Use balanced cables for balanced inputs, or standard patch cables otherwise.
- ▶ After everything is connected, power on your gear—always turn on speakers last. Start with all volumes down, then raise them slowly, using the AM4's **LEVEL** knob as needed..

 All factory presets except special templates can be used with this setup and are also compatible with headphones.

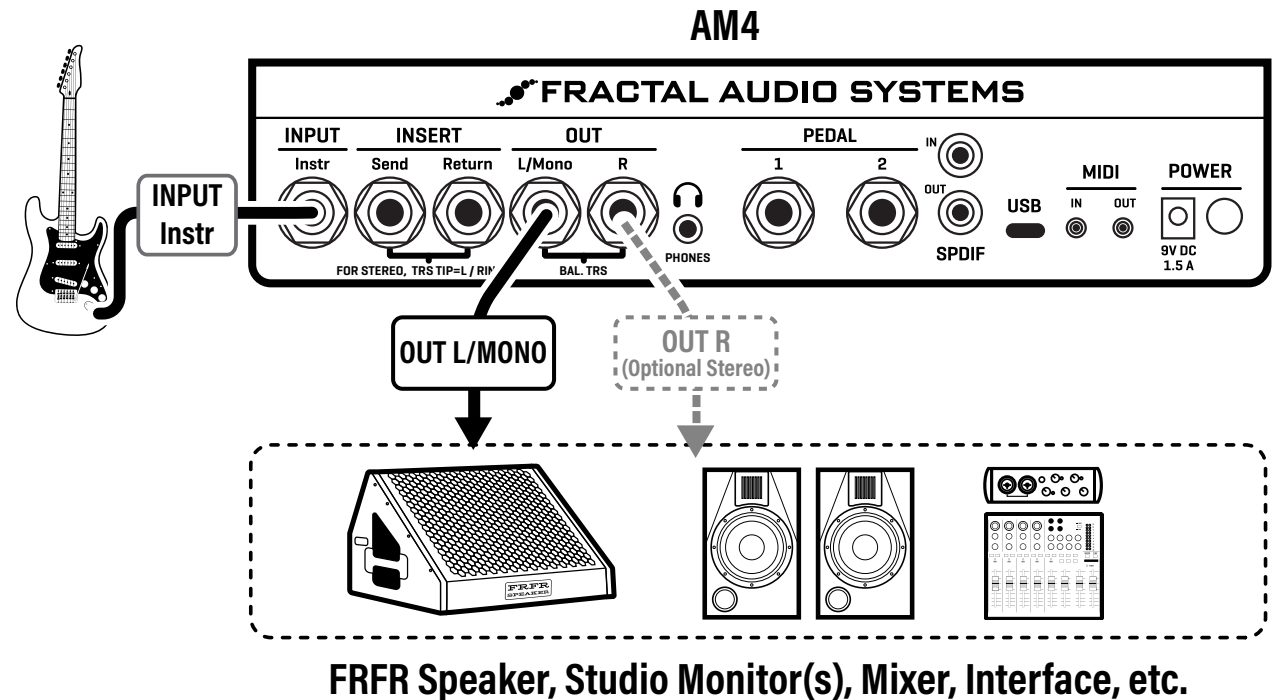

FRFR Speaker, Studio Monitor(s), Mixer, Interface, etc.

Setup: Neutral Power Amp + Guitar Cab

Use this setup when connecting the AM4 to a **neutral (FRFR) power amp** and a guitar speaker cab.

A neutral amp is typically solid-state and transparent—what goes in is what comes out, only louder. Examples include pro audio or hi-fi power amps, the Red Sound RPA series, Matrix amps, Seymour Duncan PowerStage, Orange Pedal Baby, and similar models.

A guitar cabinet is any speaker enclosure designed specifically for guitar or bass. You can even use the speaker in a combo amp, provided it can be safely disconnected from the amp's internal power section.

SETTING UP

Because this setup uses a guitar speaker cab, you must **bypass speaker simulation** in the AM4. This can be done globally under **SETUP > Global Settings > Cab Modeling**, or in any individual preset by changing the Amp block's **Cab Section** parameter to **BYPASSED**. This bypasses ALL cab settings including room, cab tone tweaks, cab expert settings, etc.

Note: Because this setup uses a flat, neutral power amp, leave SETUP > Global Settings Power Amp Modeling at its default setting of ON to preserve authentic guitar amp tone and feel.

- ▶ Power off all gear before making connections.
- ▶ Connect your instrument to the AM4 Input using an instrument cable.
- ▶ Connect the AM4 outputs to your amp:
 - For mono, use Out 1 L/Mono into your power amp input.
 - For stereo, also connect Out 1 R to a second amp channel, or a separate amp.
 - Use balanced cables for balanced inputs, or standard patch cables otherwise.
- ▶ After everything is connected, power on your gear—always turn on amps or speakers last. Start with all volumes down, then raise them slowly, using the AM4's LEVEL knob as needed.

 All factory presets (except special templates) work with this setup, but having Cab Modeling disabled makes them incompatible with headphones or FRFR speakers.

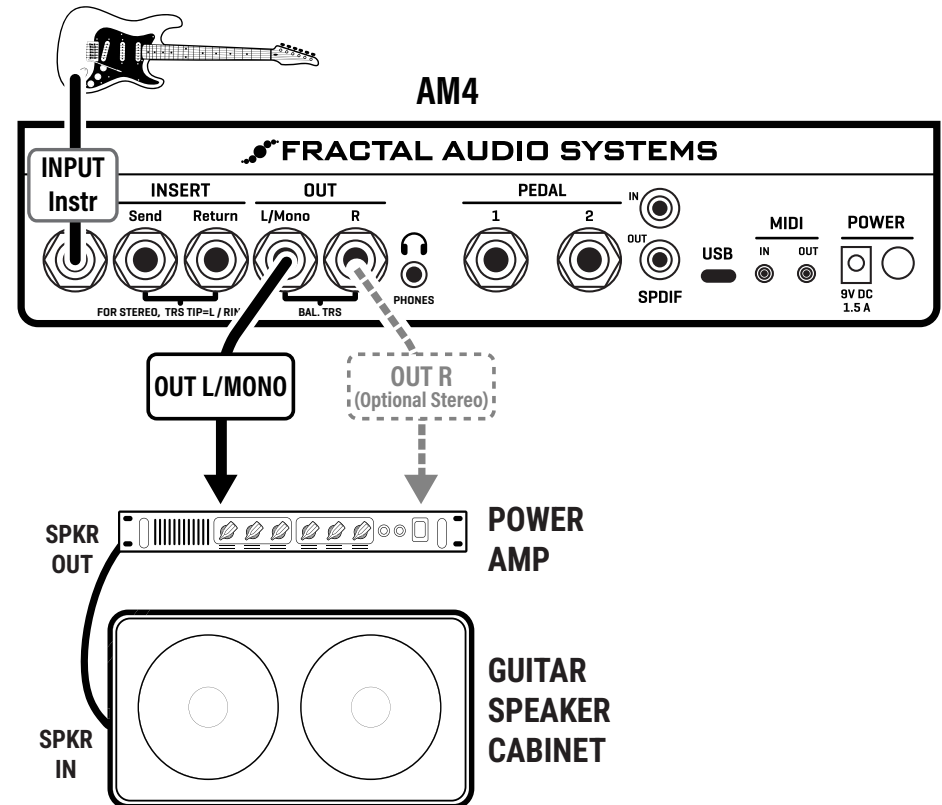

Setup: Guitar Power Amp + Cab

Use this setup when connecting the AM4 to the FX Return of a guitar amplifier or to a dedicated guitar power amp feeding a traditional speaker cabinet.

This is a non-neutral power amp, typically tube-based, designed to shape tone and dynamics as part of a traditional guitar rig.

A guitar cabinet is any speaker enclosure designed specifically for guitar or bass. You can even use the speaker in a combo amp, provided it can be safely disconnected from the amp's internal power section.

SETTING UP

Because this setup uses a guitar speaker cabinet and a traditional (non-neutral) power amp, you need to disable Power Amp Modeling in the AM4.

A real guitar power amp already shapes tone and dynamics, adding its own warmth and compression. Leaving modeling on would layer two power-amp stages, making the sound muddy or harsh.

This can be done globally under Setup > Global Settings > Power Amp Modeling, or in any individual preset by changing the Amp block's Expert Edit "Power Amp Modeling" parameter to OFF.

You must also bypass speaker simulation in the AM4. This can be done globally under Setup > Global Settings > Cab Modeling, or in any individual preset by setting the Amp block's Cab Section to BYPASSED. This bypasses ALL cab settings including room, cab tone tweaks, cab expert settings, etc.

- ▶ Power off all gear before connecting.
- ▶ Connect your instrument to the AM4 Input using an instrument cable.
- ▶ Connect the AM4 output(s) to your amp:
 - Connect Out 1 L to the return of your amp, or the input of your power amp.
 - For stereo, use a separate amp/cab or a 2-channel power amp.
 - Connect the amp to your speaker as directed by the amp's manufacturer.
- ▶ After everything is connected, power on your gear—always turn on speakers last. Start with all volumes down, then raise them slowly, using the AM4's **LEVEL** knob as needed.

 All factory presets (except special templates) work with this setup, but having Power Amp Modeling and Cab Modeling disabled makes them incompatible with headphones or FRFR speakers.

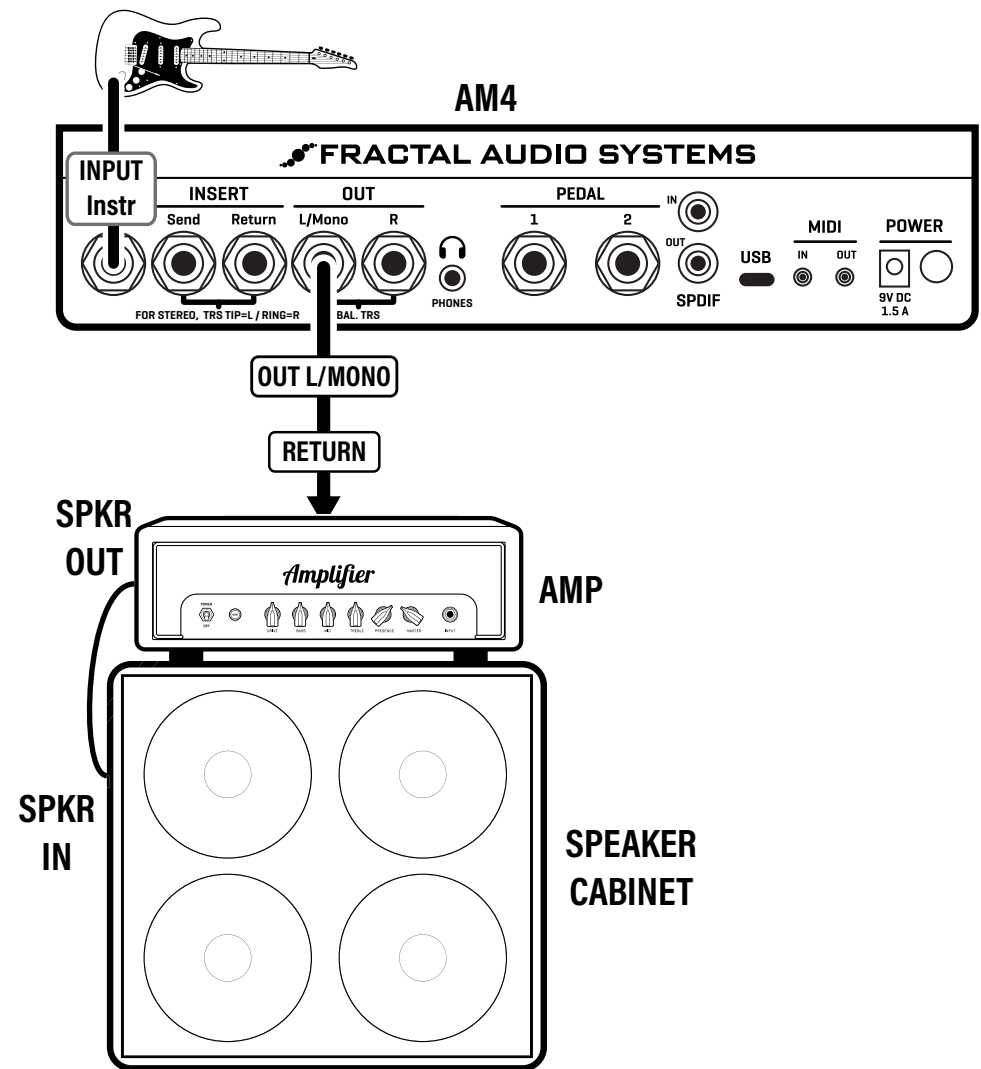

Setup: Split Mode

In Split Mode, the AM4 processes the **full amp and cab** sound on one side while sending the amp signal **without cab simulation** on the other. This setup is ideal for players who want the feel of a real amp on stage while also delivering a mix-ready tone to front-of-house. It requires Cab Modeling and Power Amp Modeling to be enabled, so your backline rig must use a neutral power amp to drive the guitar cabinet of your choice.

A neutral amp is typically solid-state and transparent—what goes in is what comes out, only louder. A guitar cab is a speaker designed for guitar or bass. See [p. 18](#) for more on these elements.

ENABLE GLOBAL SPLIT MODE

- ▶ Begin by setting **Setup > Audio > Output Mode** to “SPLIT” to enable this global configuration option.

Out 1 L has speaker cab simulation

Out 1 R has no speaker cab simulation.

In Split Mode, cab processing always occurs at the end of the signal chain, regardless of where the Amp block appears in your layout—as if the cab were a separate “block.” Split mode is dual summed mono at both outputs.

A stylized diagram below shows a simplified example of the signal flow.



SETTING UP

- ▶ Power off all gear before connecting.
- ▶ Connect your instrument to the AM4 Input using a standard instrument cable.
- ▶ Connect outputs:
 - Connect **Out 1 L** to your FRFR, mixer, or interface (**with cab simulation**).
 - Connect **Out 1 R** to the power amp feeding your speaker (**no cab simulation**).
 - Use balanced cables for balanced inputs, or standard patch cables otherwise.
- ▶ After everything is connected, power on your gear—always turn on amps or speakers last. Start with all volumes down, then raise them slowly, using the AM4’s **LEVEL** knob as needed.

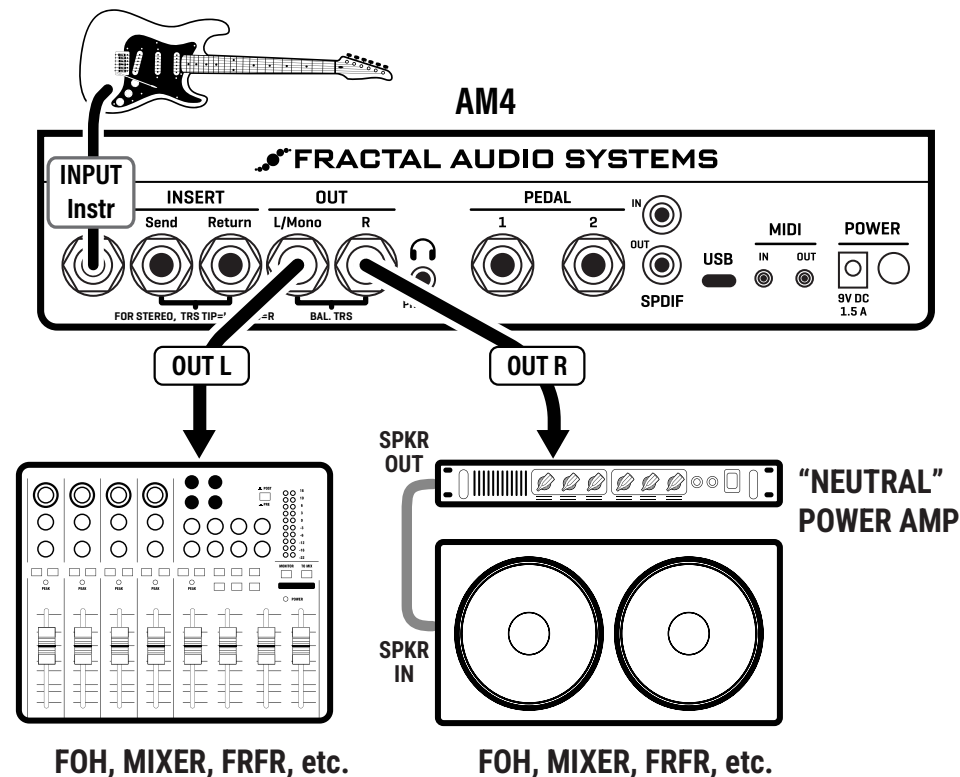

i All factory presets (except special templates) work with Split Mode enabled. Headphones will also be split, however, with no cab simulation on the right.

The AM4 includes SPDIF digital input and output for direct connection to compatible interfaces and other gear. This allows seamless integration into setups without added latency or loss from extra conversions. In and Out are covered separately below, but SPDIF In and Out can also be used simultaneously.

Setup: SPDIF Input

- ▶ Power off all gear before connecting.
- ▶ Connect a **SPDIF cable** from the SPDIF Out of your other device to **SPDIF In** on the AM4.
- ▶ Ensure that your device is set to a 48 kHz clock rate. The AM4 will automatically derive its clock from the detected digital input.
- ▶ On the AM4, set **Setup > Audio > Input Source** to “SPDIF.”
- ▶ Connect the outputs of the AM4 according to your usual setup.
- ▶ If you need to adjust the level of the incoming SPDIF signals, use **Setup > Audio > SPDIF In Level**.
- ▶ After everything is connected, power on your gear—always turn on speakers last. Start with all volumes down, then raise them slowly, using the AM4's **LEVEL** knob as needed.

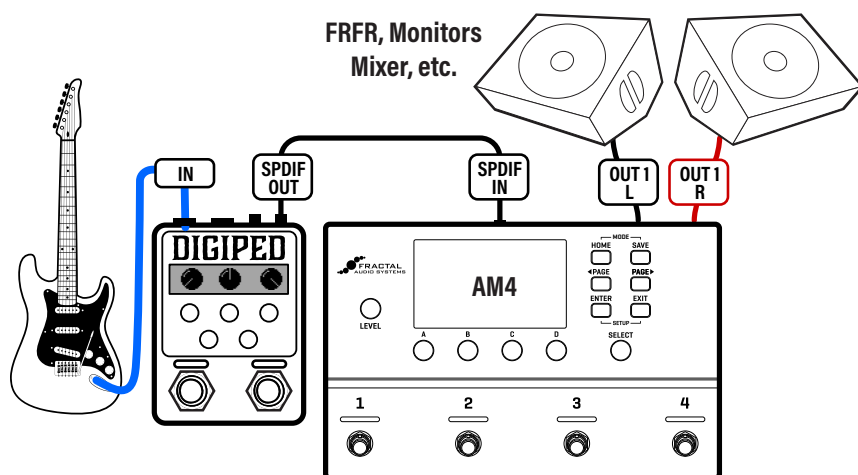

Setup: SPDIF Output

To use SPDIF Input on the AM4:

- ▶ Power off all gear before connecting.
- ▶ Connect your instrument to the AM4 Input using a standard instrument cable.
- ▶ Connect a **SPDIF cable** from the **SPDIF Out** of the AM4 to the SPDIF In of your other device.
 - **IMPORTANT:** The AM4 operates at a fixed 48 kHz clock rate. Set your receiving device to derive external word clock from its SPDIF input to ensure proper synchronization.
- ▶ Connect and monitor your external device as usual.
- ▶ After everything is connected, power on your gear—always turning on speakers last. Start with all volumes down, then raise them slowly. The **LEVEL** knob on the AM4 top panel controls SPDIF output levels.

i The AM4's analog Insert Send/Return is located after the S/PDIF Out tap, so inserted devices are not heard at the S/PDIF output. This is by design, since the Insert is intended for processing the signal sent to the balanced analog outputs.

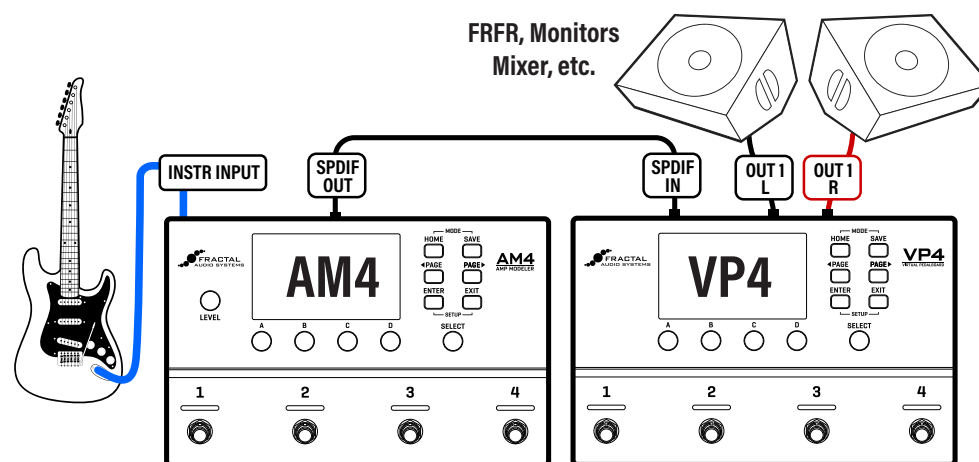

Setup: Using the Inserts

The Insert jacks provide a fixed, series insert point between the AM4's internal processing and its balanced main outputs.

The insert path is analog and has no settings or options. Its position in the signal chain is fixed at the end of the analog path, just before the balanced outputs. It cannot be moved, bypassed, or switched off, and it is not heard at the USB or S/PDIF.

Use the insert to connect external pedals or processors while preserving the clean, low-noise performance of the balanced outputs.

The general idea is that you place any pre-effects before the AM4 and any post-effects (if needed) in the insert. The AM4's balanced outs are designed to be sent directly to FOH and/or monitors. If you place post-effects after the AM4 instead, you need a DI to go direct.

SETTING UP

- ▶ Power off all gear before connecting. Set up your rig as you normally would.
- Connect the AM4 **Send** jack to your device's input.
- Connect the output of your device to the AM4 **Return**.
 - Send and Return function as a series circuit. When both are connected, the external device is inserted in-line between the AM4 and its outputs. The external device must mix the direct AM4 signal with its processed output. Start with its mix at 50/50 and adjust to taste. Set levels so the AM4 ("dry") signal remains at roughly the same level with or without the insert.
 - If you connect only the Send, the circuit is open and no sound will be heard at the AM4 outputs.
 - If you connect only the Return, you'll hear the signal present at the Return jack, but not the AM4.
- ▶ After everything is connected, power on your gear—always turn on speakers last. Start with all volumes down, then raise them slowly, using the AM4's **LEVEL** knob as needed.

MONO & STEREO

- For stereo: Use **TRS-to-dual-TS "Y" cables**—one for Send and one for Return—as shown at right.
- For mono: You can insert external gear using **standard patch cables**. In this configuration, the right output of the AM4 will be silent regardless of its Output Mode setting. To use a mono insert and maintain audio at both the left and right output jacks, use the special cable shown below.

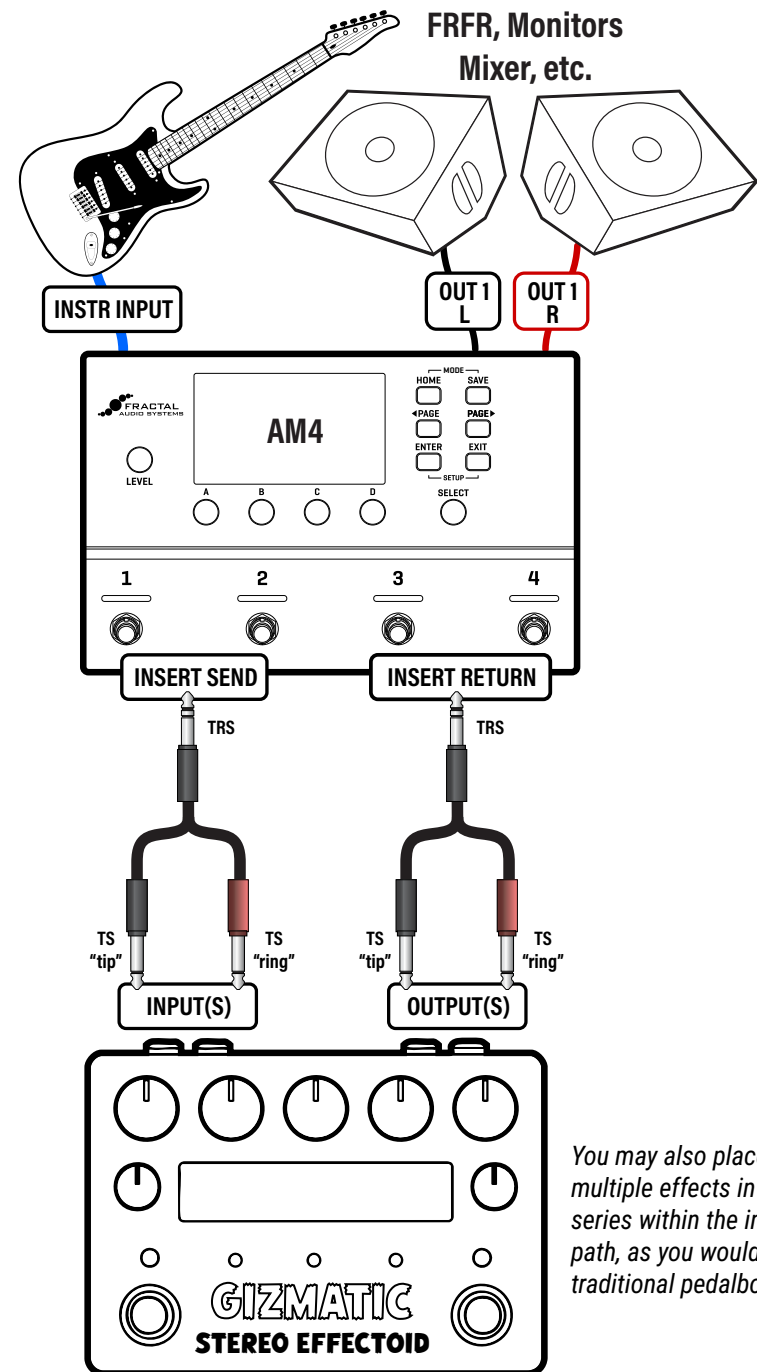
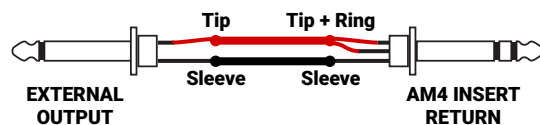

You may also place multiple effects in series within the insert path, as you would on a traditional pedalboard.

Working With Blocks

Presets on the AM4 are built from blocks. The Amp is one block, and so are Drive, Delay, and Reverb. You create a preset by selecting four blocks, dialing them in, and saving the result.

TURNING EFFECTS ON AND OFF

- ▶ Change to **EFFECTS MODE** and use the footswitches.
 - ◻ Note: The default action for the amp is BOOST instead of BYPASS.

CHOOSING BLOCKS IN A PRESET

- ▶ On the Home page, turn **SELECT** to highlight any effect or empty slot.
- ▶ Turn the corresponding **A-D** to set the **Block Type**. (Ex: "Amp" or "Reverb").
 - ◻ To remove an effect, choose "**No Effect**" from the list.
- ▶ Press **ENTER** to confirm or **EXIT** to cancel.

EDIT AMP AND EFFECT SETTINGS

- ▶ On the Home page, turn **SELECT** to highlight any effect.
- ▶ Press **ENTER** to open its editor.
 - ◻ NOTE: The edit menu for the **Amp** is also shown while you are in **Amp Mode**.
- ▶ Use the **ABCD** knobs to adjust settings. Turn **SELECT** to change rows.
- ▶ For effects with additional options, **PAGE** buttons access other pages.
- ▶ While editing, you can change the **Effect Type** by tapping **PAGE LEFT** until the **Type Picker** appears (see FAQ, right).
 - ◻ The Type page also allows you to change the **Channel**, and for the Amp, set the channel's **LED color**.
- ▶ Press **EXIT** or **HOME** when finished.

Gear Nerd? Expert Tweaker?

The AM4 was designed for ease of use, offering minimal options similar to traditional pedals. At the same time, Fractal Audio is known for its extensive depth and flexibility, allowing creative players and FX enthusiasts to dive deep into sound design.

If that sounds like you, then **Expert Edit** may be of interest. This special mode reveals expanded options for editing effects and modifiers. To open Expert Edit, press **PAGE LEFT** and **PAGE RIGHT** at the same time while editing an effect, or with an effect selected on the home page. Press **EXIT** at any time to quit Expert Edit.

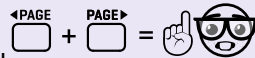

FAQ: Block Type vs. Effect Type

Effects on the AM4 are organized as "blocks" in high level categories like "**Amp**," "**Drive**," or "**Reverb**." Each block also contains an **Effect Type** picker. For instance, within the Drive block type, you can choose from effect types like "Face Fuzz," "Klone Chiron," "Super Overdrive," and many more.

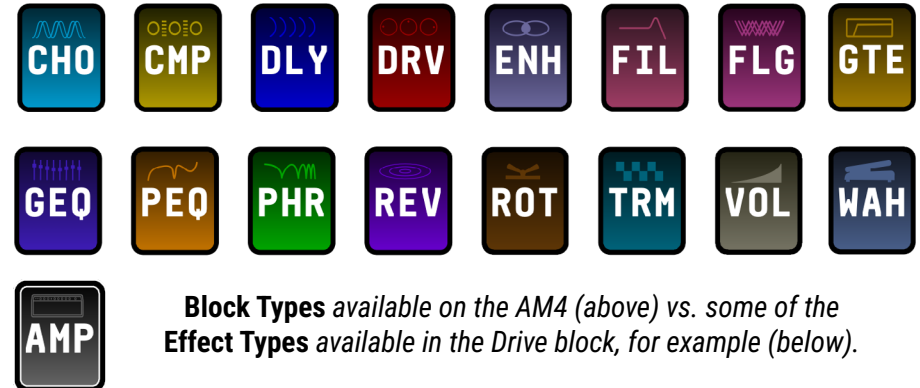

Block Types available on the AM4 (above) vs. some of the **Effect Types** available in the Drive block, for example (below).

- | | | |
|-------------------------|---------------------------|----------------------|
| • 77 Custom OD | • Gauss Drive | • PI Fuzz - Bass |
| • Angry Chuck | • Griddle Cake | • Plus Distortion |
| • BB Pre | • Guardian Photon Speed | • Rat Distortion |
| • BB Pre AT | • Hard Fuzz | • Royal Bass DI |
| • Bender Fuzz | • Heartpedal 11 | • SDD Preamp |
| • Bit Crusher | • Hoodoo Drive | • Shimmer Drive |
| • Blackglass 7K | • Horizon Precision Drive | • Shred Distortion |
| • Blues OD | • Integral Pre | • Sonic Drive |
| • Bosom Boost | • Jam Ray | • Suhr Riot |
| • Box o' Crunch | • Klone Chiron | • Sunrise Splendor |
| • Colortone Booster | • M-Zone Distortion | • Super Fuzz |
| • Colortone OD | • Master Fuzz | • Super OD |
| • Compulsion Distortion | • Maxoff 808 | • T808 Mod |
| • DS1 Distortion | • MCMLXI Drive | • T808 OD |
| • DS1 Distortion Mod | • Micro Boost | • Tape Distortion |
| • Esoteric ACB | • Mid Boost | • Timothy |
| • Esoteric Bass RCB | • MOSFET Distortion | • Tone of Kings |
| • Esoteric RCB | • NoAmp Bass DI | • Treble Boost |
| • Eternal Love | • NoAmp Bass Pre | • TS9DX + |
| • Face Fuzz | • Nobelium OVD-1 | • TS9DX Hot |
| • FAS Boost | • Octave Distortion | • Tube Drive 3-Knob |
| • FAS LED-Drive | • OD 250 | • Tube Drive 4-Knob |
| • Fat Rat | • OD 250 Gray | • Tube Drive 5-Knob |
| • FET Boost | • OD-One Overdrive | • Valve Screamer VS9 |
| • FET Preamp | • Paradigm Shifter | • Zen Master |
| • Full OD | • PI Fuzz | |

Effect Blocks Inventory

The table below lists all blocks available on the AM4 at the time of this writing, showing how many of each can be used in a single preset and how many Effect Types each block includes.

Block	Notes	Types	#
AMP	Amp + Cab Here it is! All of the amp models in one block! 245+ types, many with sub-types. The Cab section includes 45+ DynaCabs and space for 256 user cabs.		
CHO	Chorus Classic mono and stereo modulation effects including vibrato.	18	1
CMP	Compressor Controls dynamics and adds sustain.	20+	1
DLY	Delay Up to 8 seconds of delay, with types for analog, digital, tape, and more.	28	1
DRV	Drive Includes overdrive, distortion, fuzz, boost, and more.	70+	2
ENH	Enhancer Classic and modern spatialization tools that add width and clarity.	3	1
FIL	Filter Includes classic and esoteric filter types plus touch-wah and auto-wah.	18	1
FLG	Flanger Ranges from subtle modulation to "zero-cross" and extreme jet effects.	32	1
GTE	Gate / Expander Use this in addition to the built-in preset gate for creative noise shaping.	4	1
GEQ	Graphic EQ Multiple types ranging from three bands to ten, for quick tone shaping.	18	1
PEQ	Parametric EQ Five-band parametric equalizer for precise control of tone.	1	1
PHR	Phaser A variety of vintage and modern phaser effects, including Uni-Vibe style.	17	1
REV	Reverb World-class recreations of springs, rooms, plates, halls, and more.	79	1
ROT	Rotary Simulates a classic rotary speaker with multiple microphone positions.	1	1
TRM	Tremolo Essential vintage and modern tremolo styles, plus auto-pan options.	7	1
VOL	Volume Simple volume block also offers channel input/output tools for level and balance.	2	1
WAH	Wahwah The essential wah effect with multiple types based on classic originals.	9	1

Blocks Guide

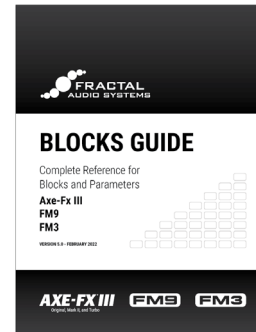

Since the AM4 is based on the award-winning Axe-Fx III, the **Fractal Audio Axe-Fx III/FM9/FM3 Blocks Guide** provides a detailed reference that is equally applicable to almost every basic and expert of the AM4 effects. (Notes for AM4/VP4 are in progress.)

The Fractal Audio Blocks Guide can be downloaded from <https://www.fractalaudio.com/fas-bg>

A Note for AXE-FX/FM9/FM3 Users

To make the AM4 easier for new users, some parameters use simplified names or labels compared to their equivalents in **Expert Edit** (p. 23). In Expert Edit, you'll see technical names (LFO Depth, Diffusion Mix), while in Basic edit, these can be more beginner-friendly (Depth, Diffusion). Names shown on Expert pages generally match those used in the Axe-Fx, FM9, and FM3, ensuring familiarity for experienced users.

Compared to our other products, the AM4 also includes a number of new or modified **Effect Types**. Some are tweaked versions of familiar effects with new interfaces—for example, "Vibrato" pedal types in the Chorus block. Others have been reorganized, such as the Reverb types.

Certain blocks include functional differences. The **Drive block** now features a switchable **Mode** control instead of separate types for certain pedals (for example, Compulsion Distortion HP/LP). **Time-based effects** on the AM4 use a revised **Mix law** derived from the VP4 "sweetened" version, optimized for use in front of an amp, and differ slightly from those on the Axe-Fx, FM9, and FM3.

These updates make the AM4 both instantly familiar to Axe-Fx users and uniquely optimized for standalone operation.

Additional notes for Fractal Audio "Veterans" appear on [p. 66](#)

The Amp Block: Amp Section

Here it is—the crown jewel of the AM4! The **Amp block** features Fractal Audio's industry-leading amp with built-in speaker cab modeling from the Axe-Fx III, letting you shape your complete tone—from amp to speaker and beyond—plus useful extras, all within a single, powerful block.

You can edit the Amp block like any other (highlight it on the Home page and press Enter), but the AM4 also includes a dedicated **Amp Mode** (see pp. 5–6). Switching to Amp Mode automatically displays the Amp Edit menu at the same time, showing essential “front-panel” controls and more. Note that this menu spans multiple pages, giving you access to the cab and more. A map appears below.

Four Amp Channels with Custom Led Colors

With channels, the Amp block is really four amps in one. Each channel (A–D) stores its own complete set of settings—including the cab—and can be recalled with a tap. For example, you might set A as a clean **Double Verb**, B as an edgy **AC-20**, C as a dimed **Plexi 100W**, and D as a soaring **USA JP IIC+**.

Use the footswitches to change the channel while editing the amp.



AM4-Edit allows you to copy channels within a preset or between presets. You can even copy just the Amp or Cab settings independently.

Amp Type Picker

This page gives access to hundreds of meticulously modeled amps. Unlike static captures or profiles, each model recreates the full circuit and controls for authentic tone, feel, and response. On this page, you can also turn **Knob C** to set the **custom LED color** for the current channel.

*Note: Read **Amp > DynaCab Linking** on the next page for more on changing types.*

Amp GEQ

A built-in Graphic EQ allows toneshaping without a separate block. Choose a type and adjust as desired. (For amps whose real-world counterparts don't include a GEQ, the EQ is OFF by default to save a small amount of DSP.)

Amp Out Boost & Level

The Amp block includes a built-in **Out Boost**, removing the need for an extra Drive, EQ, or Volume block. You can set its level from 0 to +4.0 dB per channel. To toggle the Boost, tap the Amp footswitch in **Effects Mode**, OR tap the footswitch for the current channel in **Amp Mode**. These behaviors can be customized under **Setup > Footswitches** (p. 49). The **Amp Section** can also be **BYPASSED** independently of the Cab Section (see next page).

The **Internal Levels** Meter is repeated for convenience here (see p. 13).

Amp Reset Tools

The Amp block also includes a duplicate of the **Reset** and **Soft Reset** options from the **Tools** page (p. 35) for convenient access.

THE AMP EDIT MENU MAP

You can edit the amp like any block or just enter Amp Mode. From the starting page of Basic Controls, page to additional pages of settings including the Amp Type, Cab, GEQ, tools, and more. The cab is covered on the next page.

◀ Page Left and Right through the Amp Edit Menu ▶

1. Amp Type Picker

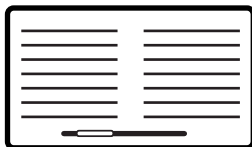

2. Basic Controls

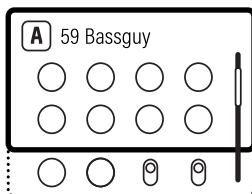

3. Amp GEQ

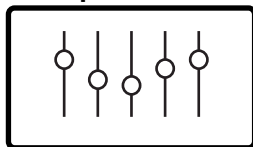

4. Cab Basics

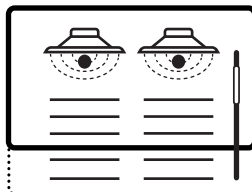

5. Cab Extras

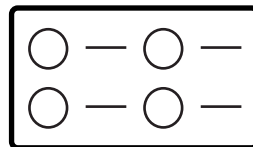

6. Levels + Boost

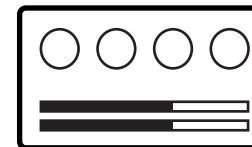

7. Reset Tool



IMPORTANT: For amps with more than eight basic controls, turn SELECT to access the third row.

The Amp Block: Cab Section

FAQ: Impulse Responses (“IRs”) and Speaker Cab Simulation

Both DynaCabs™ and User Cabs use Impulse Responses (IRs)—“captures” of real speakers, microphones, and spaces—to recreate these elements of an overall tone. DynaCabs use built-in IRs, while User Cabs let you install your own, whether purchased, free, or downloaded from Fractal Audio or trusted third-party creators, or even created yourself using the **Axe-Fx IR Capture** or using **Cab-Lab**, Fractal Audio’s IR mixing and management software.

Note that the close-mic’d sound of an IR differs from the “amp-in-the-room” experience, but this is how virtually all professional guitar recordings and performances are captured and heard—whether by an engineer behind the glass, a concertgoer in the best seat, or a fan listening to a great recording.

Two Cab Modes

The Cab Section of the Amp block recreates the sound and character of a mic’d speaker cabinet. It offers two modes—each with two slots—allowing you to blend two cab and mic sounds in the same way guitarists and audio pros have long mixed different speakers and mics in the pursuit of great tone.

Remember that each amp channel has its own fully independent cab settings.

In **DynaCab mode**, choose from over 45 built-in DynaCab™ models with visual mic positioning for intuitive tone shaping.

In **User Cab mode**, select from the IRs you’ve installed (see below).

To change the mode, open the **Cab Basics** page of the amp, turn **SELECT** to highlight **Mode**, and turn **knob B**.

User Cab Mode

User Cab Mode allows you to use your own cabinet impulse responses (IRs) in UltraRes™ or standard formats. These must be installed separately into the 256 onboard user cab slots using the Cab Manager feature of AM4-Edit or Fractal-Bot.

- ▶ To use User Cabs, open the **Amp Edit menu** and press **PAGE RIGHT** until you reach the Cab page. Use **SELECT** and **knob B** to make sure the **Mode** is set to “**USER CAB**”.
- ▶ To select an IR, turn **SELECT** to highlight the **Cab** row. As you turn knob B or knob C, the names of the selected IRs appear at the top of the page.



INSTALLING USER CABS

User Cab installation can be drag-and-drop simple using AM4-Edit. Scan the QR code at left for a simple video guide to user cabs on the AM4.

DynaCab Mode

Using a DynaCab makes it easy to dial in cab tones using a classic technique. You can position a virtual mic on a virtual speaker and hear the results in real time—just like adjusting a mic on a real cab with traditional analog gear.

- ▶ To use DynaCabs, open the **Amp Edit menu** and press **PAGE RIGHT** until you reach the Cab page.
- ▶ Use **SELECT** and **knob B** to make sure the **Mode** is set to “**DYNA-CAB**”.
- ▶ To select the cab or mic, turn **SELECT** to highlight the **Cab** or **Mic** options. Each cab and mic offers a unique sound.
- ▶ To adjust the sound, turn **SELECT** counterclockwise to highlight the **Position** and **Distance** controls at the top of the page. Adjust the controls to change the mic placement—shown on-screen as a dot.
 - **Position** (A and C): Slides the mic left or right across the speaker. Tone changes with placement. The center is brighter, the edge is darker.
 - **Distance** (B and D): Moves the mic closer or farther from the speaker. Closer = more *proximity effect* for a sound that’s bigger, bassier, and focused.

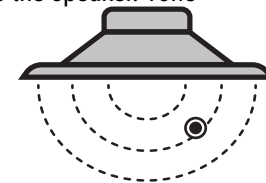

DynaCab Pre-Loading

When the AM4 is powered on, DynaCabs begin to pre-load automatically in the background. During this process, the message “**Loading Cabs...**” appears in the upper-left corner of the display.

You may experience brief slowdowns while cabs are loading. This is normal and ends once all cabs have finished loading.

Additional Cab Features

Using Two Cabs at Once

Whether you are using DynaCabs or User Cabs, the cab section allows you to use **two cabs** at once. For example, you might place both a **Dynamic** mic and a **Ribbon** mic on the same type of DynaCab, or load two totally different user Cab IRs such as a close mic and a roomier sound.

Use the **Cab Blend** control to adjust relative levels. If you're using the AM4 in stereo, you can also adjust pan for each of the DynaCabs.

NOTE: Using two cabs increases CPU usage. To turn one cab off, set it to MUTE. To reduce CPU load, lower the IR Length setting for each.

High Cut & Low Cut

The Cab Section includes Low Cut and High Cut filters to sculpt your tone.

On the **Cab Basics** page, each of the two cab slots has its own set of these controls. Another set on the **Cab Extras** page applies to the overall cab mix.

Low Cut removes low end that cause rumble or boominess. Cutting too much low end makes the tone thin or lacking in body.

High Cut removes high end for a smoother, warmer tone. Cutting too much high end makes the tone wooly or muddy.

Slope controls how steeply the filters act—from gentle (6 dB/octave) to steep (24 dB/octave).

Adjust tone at “gig levels” and in the context of a mix. For more on this, see

support.fractalaudio.com/en-US/tips-for-setting-preset-and-scene-levels-356522

IR Length

An impulse response (IR) is created by capturing how a speaker and mic respond over time after a short burst of sound. The beginning of the IR contains the main tone of the speaker, while the later part includes room reflections and subtle resonances. Shorter settings save CPU, but longer settings preserve natural resonance and even room reflections.

Room Settings

The Cab Section includes a high quality stereo room simulation based on our advanced physical reverb algorithm. You can add Room on the Cab Extra page of the Amp Edit menu, adjusting both the Room Level and Room Size.

Cab Expert Settings

The Cab Section includes a number of **Expert Edit** parameters including Mic Preamp simulation, expert Room parameters, “Air” and more. You can learn more about these in the Fractal Audio Blocks Guide ([p. 24](#)). Recognize that some of these can have a significant impact on CPU levels.

Amp->DynaCab Linking

In most cases¹, selecting a new Amp Type resets the Amp—including all Cab settings—to their defaults, and automatically loads a matching or closely related **DynaCab**. If you prefer to manage cabs manually, you can disable this feature in the **SETUP > Global Settings > Amp- > Cab Type Linking**.

To selectively keep Cab settings when changing the amp type, hold **ENTER** while turning **SELECT**, then release **ENTER** to apply the change.

In **AM4-Edit**, you can hold **SHIFT** while selecting a new amp from the list to achieve the same result.

¹ The Cab will NOT change when you switch between two types of the same amp—**Recto 2 Orange** and **Recto 2 Red**, for example.

Understanding CPU

In the AM4, the CPU is like the “brain,” managing all audio processing, effects, and system functions. A **CPU meter** in the upper-right corner shows how much processing power is being used.

The processor is extremely powerful and can run complex presets. A dynamic limit of about 85% ensures smooth performance. Because this limit adjusts in real time with audio activity, the CPU meter may rise slightly as you play. If you exceed the limit, you may hear audio crackles. When CPU usage surpasses the safe threshold, the unit displays “**CPU LIMIT: Bypassed**” in the upper-left corner of the main display and the AM4 bypasses all processing.

CPU usage varies based on the number and type of effects in a preset, their settings, modifiers, and other factors. Even an empty preset uses a small amount of CPU. As you add effects or increase complexity, the CPU level rises. A good rule of thumb is to aim for 80% or lower, then test your preset during actual play.

CPU TIPS

- ▶ **Bypassed** blocks still use CPU to stay ready for instant activation.
- ▶ Modifiers use a small amount of CPU, and their expert **Update Rate** setting impacts this usage.
- ▶ If you need multiple types of an effect but don't need them both to be active at the same time, you can use one block with different **Channels** instead of two separate blocks, saving considerable CPU. Learn more about Channels on [p. 36](#)
- ▶ Different **Effect Types** ([p. 23](#)) within a block can use varying amounts of CPU. For example, in the Delay block, the “Analog Stereo” uses around 6% CPU, while the “Digital Mono” uses about 4%. In the Reverb, “Spring” types use less CPU. Experiment with changing types to see which are more or less CPU-hungry.
- ▶ Drive block types also vary. If you need a low-CPU option, consider Shimmer Drive or FET Boost. For a completely clean boost, try an EQ, Filter, or the amp's **Input Boost** in Expert Edit.
- ▶ Effect **settings** can influence CPU load. Lowering **Quality** or **Density** in the Reverb block, for example, can make a big difference.
- ▶ Use **gapless switching** to spread effects across presets instead of running everything at once. (Note that ensuring spillover between different presets requires special attention. See [p. 34](#) for details.)
- ▶ **Expert Edit** ([p. 23](#)) provides additional parameters that can further reduce CPU usage.
- ▶ Visit our forum for expert tips and advice on getting the most out of the AM4.

Saving Changes

If you edit a preset and want the changes to be retained for future use, you must **SAVE**. Unsaved changes are lost when you switch presets or power off the unit.

Every preset in the AM4 can be saved, renamed, or overwritten.

To save, press the **SAVE** button. From here, you can press **ENTER** twice to confirm, or edit the **preset name** or **scene names** before saving.

When you adjust any preset, the front-panel EDITED indicator lights. This appears in the title bar as a small yellow dot with an “E”.[Ⓔ]

NOTE: The AM4 considers any of the following actions as editing a preset: changing effect settings, editing the Input Gate, Main Levels, or Preset EQ), turning effects on or off, changing the Scene or tempo, or adjusting controllers.

TO SAVE A PRESET

- ▶ Press **SAVE** to show the Save page.
- ▶ Press **ENTER** to Save. You'll be prompted to press **ENTER** again to confirm.
- ▶ The message “**SAVED!**” is shown when saving is complete.

TO CHANGE PRESET OR SCENE NAMES

You can edit the name of any preset or its scenes while saving.

- ▶ Press **SAVE** to show the Save page.
- ▶ Select the **NAME** fields to edit the preset name any of the Scene Names.
 - ◻ Turn the knob **A** to move the cursor.
 - ◻ Knob **B** selects **UPPER CASE** letters and **space**
 - ◻ Knob **C** selects **lower case** letters and **space**.
 - ◻ Knob **D** selects **numbers and symbols** and **space**
 - ◻ **Page Left** = DELETE character. **Page Right** = INSERT character.
 - ◻ You can use up to 31 characters in a preset name.
- ▶ Press **ENTER** to Store, then press **ENTER** again to confirm.

Presets

Each preset in the AM4 stores a complete amp, cab, and effects setup—your own ready-to-play rig.

Every preset includes your chosen Amp (including its Speaker Cab) and up to three additional effect blocks, along with its own Noise Gate, Master EQ, and level settings.

Each block offers multiple channels, extending the flexibility of every preset and allowing you to switch between variations of the same effect or amp within a single setup.

Presets make it easy to switch instantly between complete tones and configurations. Some players might use one versatile preset for an entire show, while others create dedicated presets for clean, crunch, and lead sounds—or even separate ones for each song in a set.

Preset Banks

The AM4 organizes its presets into 26 banks labeled A–Z, each containing four presets numbered 1–4.

For example, the first bank includes presets A1–A4.

This makes it easy to tell from the preset's number which footswitch it will appear on.

LOAD PRESETS IN PRESET MODE

- ▶ Press footswitches 1 and 2 at the same time to show **Mode Select**.
- ▶ Press footswitch 1 to enter **Preset Mode**.
- ▶ Tap the footswitches to select one of the four presets in the current bank (e.g., A1–A4).
- ▶ To change the **BANK** in Preset Mode using the footswitches, press and hold Switch 4 or Switch 1 to step up or down through the banks.

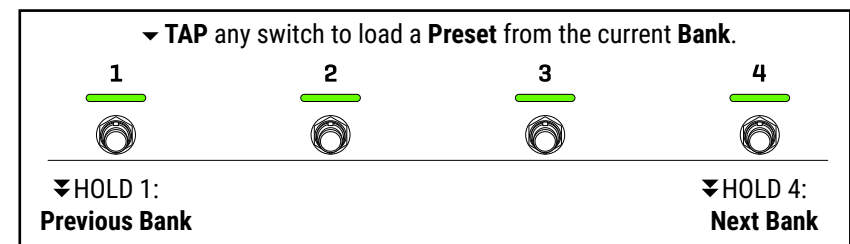

- ▶ On the **Home page** in Preset Mode, you can also turn **Knob A** to browse the entire list of presets on the AM4. Inside the preset list, **Knob B** changes the bank.
- ▶ To delve further into the options within any particular preset, return to Mode Select and then enter Scene Mode with footswitch 2, or try Effects Mode to turn effects on or off.

CHANGE PRESETS IN SCENE MODE

- ▶ In Scene Mode, hold **Footswitch 4** to change the preset up (+1) or hold **Footswitch 1** to change the preset down (–1).

CHANGE PRESETS USING MIDI

- ▶ In any mode, you can change presets using a standard MIDI Program Change message. A table on [p. 59](#) shows the preset-to-program mapping.

Preset Tutorial

Load an Empty Preset

- ▶ Change to **Preset Mode** (Press **Home**, turn **Select** hard left), then turn **knob A** to any <Empty > preset and press **ENTER**.

Add the Amp block

- ▶ Turn **SELECT** until the **second effect slot** is highlighted.
- ▶ Turn **knob B** until the **Amp** effect is shown and then press **ENTER**.
- ▶ Press **ENTER** again to edit the Amp. The Amp Types page will appear.
- ▶ Turn **knob A** to cycle through the types. (Knob B moves faster.) Choose the type "**AC-20**" and then press **ENTER**.
 - This AC-20 is a nice, chimed "Class-A" model with smooth breakup and great touch response.
- ▶ **Page Right** to the basic settings for the Amp.
- ▶ Adjust the amp's gain and other controls however you like. Turn **Select** to highlight to the second row, where you can experiment with the additional options there.
- ▶ Press **EXIT** when you're done.

Save the Preset

- ▶ Press the **SAVE** button.
- ▶ We're not going to change the **LOCATION** but let's edit the **NAME**.
 - Turn **SELECT** to highlight the NAME line.
 - Use: **Cursor** (knob A) **A-Z**, (knob B) **a-z** (knob C) **0-9** (knob D)
- ▶ Enter the name "**My AM4**".
 - If you make a mistake, **PAGE LEFT** and **PAGE RIGHT** can be used to delete or insert characters.
- ▶ Press **ENTER** twice to commit your changes.

Add a Drive Effect

- ▶ Turn **SELECT** until the first effect slot is highlighted.
- ▶ Turn **knob A** until the **Drive** block is shown and then press **ENTER**.
- ▶ Press **ENTER** again to edit the Drive. The **Types** page will appear.
- ▶ Turn **SELECT** or **knob A** to highlight the "T808 OD" type and then press **ENTER**. (That's a "screamer" overdrive).
- ▶ **Page Right** and dial in **Drive**, **Tone**, and **Level**. You can use the first footswitch to turn the effect on or off while you work.
- ▶ **SAVE** the preset again when you're done. (Save, Enter, Enter)

Add a Delay Effect

- ▶ Turn **SELECT** until the third effect slot is highlighted.
- ▶ Turn **knob C** until the **Delay** block is shown and then press **ENTER**.
- ▶ Press **ENTER** again to edit the Delay. The Types page will appear.
- ▶ Turn **SELECT** or **knob A** to highlight the "Digital Mono" type and then press **ENTER**.
- ▶ **Page Right** and dial in the basic settings for the Delay.
 - Turn the page right for modulation and other extra settings.
- ▶ You can use the first footswitch to turn the effect on or off while you work.
- ▶ **SAVE** the preset again when you're done. (Save, Enter, Enter)

Add a Reverb.

- ▶ Use what you've learned to add a **Reverb** block in slot 4.

Want to learn more?

To explore more of what a single AM4 preset can do, continue to [p. 40](#) where this tutorial dives into Channels and Scenes—two features that greatly expand the flexibility of your sounds.

Input Gate

HOME ... PAGE RIGHT 1x

Every preset includes an adjustable noise gate, referred to as the **Input Gate**, to distinguish it from the Noise Gate in the dedicated Gate block.

Located at the input—before any other blocks—it reduces unwanted noise or hum by lowering the signal when it falls below a set threshold, especially useful with high-gain amps or in noisy environments.

The Input gate has the following controls:

Gate Type – The “CLASSIC” type opens and closes like a typical gate pedal. The “INTELLIGENT” and “NOISE REDUCER” types use precision filtering to minimize noise from electromagnetic interference (“EMI”). For these gates to work effectively, it is crucial to set **SETUP > Global Settings > AC Line Frequency** based on your location. The default setting of “60 Hz” is suitable for North America and most of Central and South America. The “50 Hz” setting is for Europe, Asia, Africa, Australia/New Zealand, and parts of South America such as Argentina and Chile.

Threshold – Determines how quiet the signal must be for the gate to close. Higher settings make the gate more aggressive, closing on louder signals. To turn the gate completely off, set this control fully counterclockwise.

Release – Sets how long it takes for the gate to close after the signal falls below the threshold, typically when you stop playing. Use lower values for a tight, fast, abrupt cutoff or higher values for a slower fade.

Level – This adjusts the level of the signal coming out of the gate if you need a boosted level going into your effects.

INPUT GATE EXPERT SETTINGS

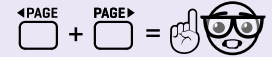

The Noise Gate includes several expert parameters. These will be familiar to users of other Fractal Audio products or those who like to explore deeper sound design options. While on the Input Gate page, press **PAGE LEFT** and **PAGE RIGHT** together to open the Expert Settings page.

Ratio: Controls the strength of the gate. Higher ratios reduce noise more dramatically when the gate is closed, while the lowest setting (1:1) has no effect.

Attack: Determines how quickly the gate **opens** after the signal exceeds the threshold—typically when you start playing. Choose a fast setting for a tight, aggressive response, or a slower one for a gradual opening. The default of 2.0 ms is a good starting point. Note: setting gate times too fast can cause distortion!

INPUT IMPEDANCE



The **Input Impedance** setting, found in the Expert Settings for the Gate (above), controls how the AM4 uses real analog components to vary the load on your guitar pickups. This replicates the tonal interaction between pickups and classic analog pedals such as vibe or fuzz effects.

In the default AUTO mode, impedance is set automatically based on the first active effect in your preset. This behavior—applied even if you never open the Expert page—is generally best, but you can also select a fixed value if desired.

Main Levels

HOME ... PAGE RIGHT 2x

The Main Levels page of every preset contains the master **Preset Level** and **Preset Balance** controls. **Amp Level** is also repeated here for convenience.

In addition, each Scene also has a **Scene Level** control which can be used to trim the level of that scene +/- 20 dB.

Preset EQ

HOME ... PAGE RIGHT 3x

Every preset has its own master 10-band EQ. The EQ setting is applied at the output. All effects and scenes in the current preset are processed by the EQ.

Preset Mix/Routing

HOME ... PAGE RIGHT 4x

The **Preset Mix/Routing** page is like a “Command Center” for the various mix-related settings for all effects in the current preset. It shows the four effect types and allows you to adjust their Mix, Level and other settings without bouncing between menus. To navigate this page, turn **SELECT** to the desired row, and turn **ABCD** to adjust settings for the four effects.

TIP: In Scene Mode, this page is an excellent Scene Manager. Use the four footswitches to change scenes while adjusting bypass, channel, level, and more.

Bypass – Use this to bypass/engage effects outside of Effects Mode.

Channel – Changes the **Channel** of the selected effect. Remember that each channel has its own settings for all parameters – including Mix, Level, Bypass Mode, Kill Dry, etc.). Channels can even have a different Effect type – just not a different Block Type). See [p. 36](#) for more on Channels.

Mix – This adjusts the balance of “Dry” and “Wet” for the effect. Effects with no mix, such as Wah, GEQ, etc., will show “NA”.

Level – This adjusts the total level of the effect, both wet and dry.

Meters – Each column shows input level (blue) and output level (green). The meter turns red when clipping occurs, making this page useful for finding and fixing overloads within a preset.

Bypass Mode – Determines how an effect behaves when bypassed. For time-based effects, the default Mute FX In allows tails to continue when bypassed. (In this mode, Level still affects the dry signal.) For non-time-based effects, the default Thru acts like analog true bypass, passing the signal unchanged. Additional options are described on the next page.

Kill Dry – Kill dry is provided for those who run time-based effects in **parallel** (see “Routing” below). With Kill Dry turned on, no DRY signal passes through the block. Instead, the **Mix** control functions as a level control for the Wet signal only, potentially making parallel effects easier to use.

i *NOTE: For the Amp block, **Bypass** and other settings affect the entire block. The **Level** control on this page, however, adjusts **Amp Level**.*

*If the **Amp Section** within the block is set to **BYPASS**, this field shows “–”, and you’ll need to use **Cab Master Level** on p. 5 of the Amp Edit menu to adjust block levels instead.*

Routing – Determines whether Effects 2–4 are in Series or Parallel with respect to the previous block. A dynamic diagram shows the signal path as you change settings.

Example: Setting **Effect 3** to **Parallel** places it alongside Effect 2, as shown in the illustration.

Remember, Series or Parallel always refers to the previous block—so Effect 2 is in series with Effect 1, and Effect 3 is parallel to Effect 2. Effect 1 cannot be set to parallel because there is no previous block.

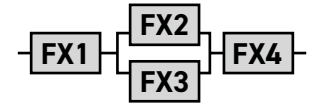

FAQ: Why Do People Use Parallel Effects?

If you, like most people, have always strung pedals together in a chain, you’ll be comfortable with the default settings on the AM4, with four effects in series.

The option to run effects in parallel does create certain creative sound design opportunities however. An easy example to understand is Reverb and Delay in series or in parallel. In series, you hear reverb on the dry (what you play) and the wet (the echo that follows). In parallel, only the dry signal passes into the reverb, so the echoes that follow are dry, with no reverb.

MYTH: Time-based effects sound better in parallel.

FACT: On the AM4, time-based effects work just as well in series as they do in parallel, with no difference in the dry signal’s level or tone.



First, adjusting **Mix** for time-based effects does not affect the dry level until settings exceed 50%, making it easy to maintain a consistent dry level.

Second, The AM4’s “dry” routing is handled entirely in the digital domain. There’s no analog compromise as with traditional gear or pedals, and no need for a parallel dry.

In short, you can easily achieve excellent results with series effects. If anything, it’s *parallel* effects that require extra effort, as you’ll need to either 1) turn on **Kill Dry** if available for that block, or 2) adjust the **Mix** to 100% and set **Bypass Mode** to “Mute In” or “Mute Out.”



*Because parallel effects require special settings, the AM4 has a built-in “Help” page with a reminder. To view it, select any **Routing** parameter on the Mix Overview page and then press **ENTER**.*

Bypass Mode

Bypass Mode might be considered an expert feature, since most players won't need to adjust it often. Understanding it can still be useful, however.

You can set Bypass Mode for an effect to determine how it behaves when bypassed. Each channel of an effect can have its own Bypass Mode, allowing for different behaviors across channels. While not every block type has this feature, most do.

You can find Bypass Mode for each effect on the **Home > Preset Mix/Routing** page. It's also available in **Expert Edit** (p. 23) for each effect.

The default setting of "**Mute FX In**" for time-based effects allows spillover of tails when the effect is bypassed. The default setting of "**Thru**" for non time-based effects behaves similarly to "True Bypass" on a pedal – while bypassed, that effect has no impact whatsoever on the sound.

Different effects include additional options, detailed below and at right.

TIP **USING CHANNELS?** If so, remember to check the Bypass Mode setting for each one. See p. 36 for more on Channels.

MUTE – When the block is bypassed, both wet and dry are silenced.

THRU – When bypassed, the block is completely disengaged. None of its parameters have any effect on the sound. It behaves like an empty effect.

MUTE FX IN – When the block is bypassed, the inputs to the wet portion of the effect are muted, effectively turning off the effect while "tails" ring out or "spillover." The dry signal remains the same whether the effect is on or off.

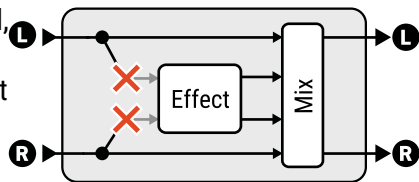

Note that **Level**, **Balance** and other parameters that affect the Dry signal continue to do so even when the block is bypassed.

MUTE FX OUT – When the block is bypassed, the outputs of the wet/effect are muted, ending tails immediately. The bypassed effect continues to process audio, so tails are already present when you turn it back on. The dry signal remains the same whether the effect is on or off.

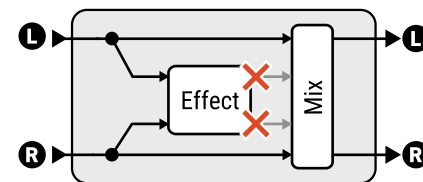

Note that **Level**, **Balance**, and other parameters that affect the Dry signal continue to do so even when the block is bypassed.

MUTE IN – When the block is bypassed, its inputs are muted. This ultimately silences both wet and dry signals but allows effect tails to spill over. Use this mode when you want tails on a time-based effect in parallel and **Kill Dry** is not on or available.

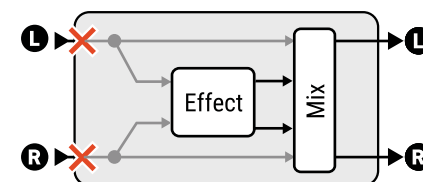

MUTE OUT – When the block is bypassed, all audio is totally silenced immediately, but the input is still "listening," so tails will be "pre-loaded" when you engage the effect. Use this mode when you want no tails on a time-based effect in parallel and **Kill Dry** is not on or available.

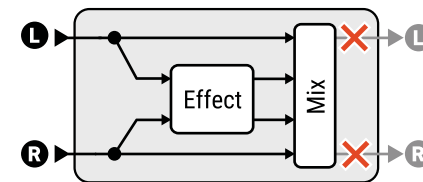

Spillover

Spillover allows delay and reverb tails to “ring out” when an effect is bypassed or you change scenes or presets. This section covers how to set up spillover in different scenarios.

When Bypassing an individual Effect

For tails that ring out when a block is bypassed, set the block's **Bypass Mode** (p. 33) to “MUTE FX IN”. This is the default setting for most time-based effects. For effects routed in **parallel** (p. 32), use “MUTE IN” instead.

When Switching Channels

Spillover will continue when you change an effects channel, but be aware that different channels use the same memory, so changes to parameters like type, time, or size may cause a “sweep” effect in the tail. To ensure perfect spillover, use multiple blocks of the same type instead of changing channels.

When Switching Scenes

Since scenes simply bypass or engage blocks, and potentially change their channels, see the two entries above to ensure perfect spillover.

When Changing Presets

Spillover between presets is more involved. First, go to **SETUP > Global Settings** and set the **Spillover** parameter to determine whether “DELAY,” “REVERB,” or “DELAY & REVERB” will spill over when switching presets.

You must also ensure the exact same blocks exist in each preset you switch between. For the Delay to spill over, it must be present in both presets.

The blocks must also have similar settings and placement. For example, if you switch from a preset where **Delay** is a “**Digital Mono**” delay with Time 200 ms, to one where **Delay** is an “**Analog Stereo**” with Time of 500 ms, the tails and tone will not be consistent across the change. Similarly, you might hear a difference in the tail if a block is placed before or after another effect across different presets.

Disabling Spillover

You can also disable spillover when you prefer effect tails to stop instantly.

Set **Bypass Mode** to THRU or MUTE FX OUT to cut a delay or reverb tail as soon as an effect is bypassed.

To disable preset-to-preset spillover, set **SETUP > Global Settings > Spillover** to OFF.

TRY IT!

Spillover in a Single Preset

- ▶ Place a Delay block in a preset. Turn up Mix and Feedback. Change to **Effects Mode** and use a footswitch to bypass the effect—you'll hear spillover.
- ▶ The same behavior occurs if a scene toggles the block on or off. If you're using multiple channels, be sure each has appropriate settings. Changing parameters such as Time, Mix, or Feedback will affect both the existing tail and any new audio you play.

Spillover across Presets

- ▶ Change **SETUP > Global Settings > Spillover** from its default setting of “OFF” to “ALL”.
- ▶ Save an exact copy of your preset to a new location and test spillover as you change between the two copies. You can use this technique as a starting point, making changes in the new preset without disrupting any of the settings that affect spillover.

Reset Tools

HOME ... PAGE RIGHT 5x

The Tools page allows you to reset parts of the current preset to their factory default settings. Use these options when you want a completely fresh start, or as a troubleshooting step.

Each block includes separate tools for individual channels, as well as a Reset All Channels option. The currently selected channel is indicated by a dot.

You can also reset elements that don't appear as blocks on the Home page, including Gate, Main Levels/EQ, and Controllers.

 Because the Amp block is reset more frequently, its Reset tools also appear for convenience on the last page of the Amp Edit menu.

PERFORMING A RESET

- ▶ Turn **knob A** to select a category from the left column.
- ▶ Turn **knob C** to choose a tool (some categories have only one option).
- ▶ Press **ENTER** to execute and confirm.
- ▶ Remember to **SAVE** the preset after performing any resets if you want the changes to be permanent.

Note: Resetting an effect or channel does NOT remove any modifiers. To remove all modifiers, address them individually, or just remove the entire block and reinsert it into the preset.

About Soft Reset

The **Soft Reset** function is unique to the Amp block and appears when you select the **Amp block** on the Tools page.

This resets the selected amp model while **preserving many basic settings**.

Soft Reset refreshes all advanced and hidden parameters while leaving key front-panel controls—such as Gain, Bass, Mid, Treble, Presence, Level, and even GEQ—unchanged.

Use Soft Reset anytime you want to ensure that your amp behaves exactly as intended while keeping your preferred tone settings, or when amp modeling is updated by a major firmware.

Troubleshooting

The following built-in utilities can help resolve problems that may occur under certain conditions.

Problems after a Firmware Update

A built-in recovery system known as the **Emergency Boot Loader** protects against mishaps during firmware installation.

To use the Emergency Boot Loader:

- ▶ Power down the unit and wait five seconds.
- ▶ Power on while holding **HOME** until the **Emergency Utility** appears.
- ▶ Install firmware using Fractal-Bot in the usual way.

Problems with a Single Preset

If the unit will not boot normally, the problem may be caused by the current preset. To load an empty initialized preset:

- ▶ Power down the unit and wait five seconds.
- ▶ Power on while holding **ENTER** until the splash screen appears.

The unit will start with an empty initialized preset in location A1.

You can then **STORE** this to any location to overwrite a problematic preset.

Problems with Global Settings

In rare cases, a corrupted or problematic system parameter may prevent the unit from booting normally.

To reset all system parameters to their default values:

- ▶ Power down the unit and wait five seconds.
- ▶ Power on while holding **EXIT** until the boot-up progress bar first appears.

This process does NOT affect stored Presets or User Cabs.

Intro to Channels

Each block on the AM4 provides four complete variations called **Channels**—A, B, C, and D. A channel stores a **full set** of parameters for that block, allowing you to switch instantly between completely different sounds. You can change channels **manually** or as part of a **Scene**.

For the Amp block, each channel includes all settings for both the Amp and Cab sections, giving you four complete tones within a single preset. Unlike other blocks, each amp channel also has its own custom LED color.

While channels can't change a **block type** (for example, Drive vs. Delay), they can change the **Effect Type** within a block. For instance, one Drive block might have Channel A set to T808 Overdrive, Channel B to Face Fuzz, and so on. Channels make each block extremely versatile.

SELECT A CHANNEL

The AM4 offers multiple ways to select a channel.

- ▶ In **Amp Mode**, tap any of the four footswitches to change to that channel.



- ▶ In **Effects Mode**, **press and hold** any footswitch to display a **Channel Picker**.
 - An on-screen menu shows the assigned **Type** for each of the channels.
 - **Tap** any footswitch to change the channel and exit.
 - **Press and hold** to change the channel and stay in the picker.
- ▶ **While Editing an Effect** – Page left to the “Type” page and turn **Knob D**.
- ▶ Use the **Preset Mix/Routing** page ([p. 32](#)).
- ▶ **MIDI** – Channels can also be changed using **MIDI** ([p. 51](#)).

SETTING UP CHANNELS

To set up a Channel, simply select it as described above, change the various settings, and then save the preset. Note that any **MODIFIERS** ([p. 41](#)) apply to all channels.

*Note: Amp channels also save the current state of the **Out Boost** (on/off).*

Intro to Scenes

Imagine a traditional rig where you might need to turn several **effects** on or off or change **amp channels** quickly to set up different sounds. **Scenes** on the AM4 make this easy, letting you recall complete combinations of effects, levels, and amp/cab setups with a single action—no “tap dancing.”

Scenes can also change effect Channels (left), allowing instant transitions between entirely different amp/cab and effect combinations within a preset. Because of this, Scenes are a great way to switch sounds on the AM4.

Scenes don't need to be “created”—they're already there, ready to be set as desired. Remember that you must save the entire preset to store Scene changes. When saving, you can also give each Scene its own name.

With four Scenes per preset, you can create a range of instant access tones—from clean to rhythm to lead and more—without switching presets.

SELECT A SCENE

- ▶ In **Scene Mode**, tap a footswitch to select the corresponding scene.

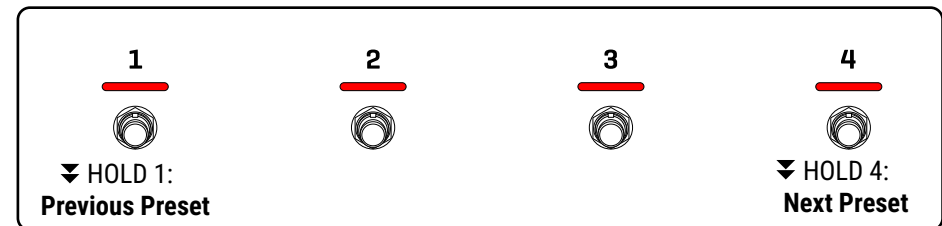

- ▶ On the **Home Page**, you can also highlight the Scene name and press **ENTER** to use a **Scene Picker**.
 - **MIDI** can be used to select Scenes using the various options in the **SETUP > MIDI/Remote** menu ([p. 51](#)).
 - **AM4-Edit** provides an easy, one-click way to change the Scene.

Working With Scenes

SETTING UP SCENES

Whenever you edit a preset, you setting up the current Scene. Setting up additional scenes is easy. Here are step-by-step instructions:

- ▶ Change to **Scene Mode** and select the desired Scene.
- ▶ Change to **FX Mode** and turn Effects ON or OFF using the footswitches.
- ▶ Set the **CHANNEL** for each block as desired ([p. 36](#)).
- ▶ Test and save your preset, adding names to your scenes as desired. See [p. 28](#) for more on saving changes.

Scenes Example:

SCENE 1



In this example, Amp and Reverb ON and Drive and Delay are OFF,

The amp is set to Channel A, which we'll imagine as an edgy AC-20.

SCENE 2



In this scene, the Drive and Delay turn ON, the Reverb turns OFF.

The Amp changes to Channel B, which we'll say is a "Plexi 50W"

! *IMPORTANT: Scenes do not store individual parameter values. If you want an effect to have different settings in different scenes—even for a single knob—you'll need to switch that effect to a different Channel. The flip side of this offers one of the great advantages of Scenes: any change you make to a Channel automatically applies to all Scenes that use it, making it easy to keep sounds consistent across multiple Scenes.*

ADJUST SCENE LEVELS

Scenes can adjust the overall output level, letting you fine-tune loudness when it's not practical to change levels elsewhere. Note that this happens at the output stage, so it also affects delay or reverb tails. If a scene can't be raised without clipping, lower the others instead. To set scene levels:

- ▶ Press **HOME** and then change to **Scene Mode** first so you can use the footswitches to check levels as you change Scenes.
- ▶ Press **Page Right** 2x to the **Main Levels** page.
- ▶ Use **SELECT** and **ABCD** to adjust Scene Levels.
- ▶ Save the Preset.

The Default Scene

When a new preset is loaded, it starts on the Scene that was active when the preset was last saved. To set this up for any preset, select the desired Scene and save the preset.

If you'd prefer to override this behavior and have every preset always load to a specific Scene (such as Scene 1), go to **SETUP > Global Settings > Default Scene**.

Scene MIDI

Each scene in every preset can be configured to send up to four MIDI messages—either **Program Change (PC)** or **Control Change (CC)**—to external MIDI devices.

This allows the AM4 to control other gear automatically when switching scenes for fully synchronized performance changes.

To set up Scene MIDI messages:

- ▶ Open the **Scene MIDI** page: from Home, press **PAGE RIGHT** 6x.
- ▶ Turn SELECT to choose a scene and message slot.
 - There are four MIDI messages for each scene, running vertically down.
- ▶ Enter the Desired MIDI message.
 - Use Knob B to select the message type (PC or CC#0–127).
 - Use Knob C to choose the MIDI channel (1–16).
 - Use Knob D to set the specific value for the PC or CC message.
- ▶ Press ENTER on a selected row to test an individual message, or switch to Scene Mode and use the footswitches to test all of the messages for any scene.
- ▶ Save the preset to retain your settings.

When a new preset loads, the MIDI messages for its default scene are sent automatically.

Note: Scene MIDI is transmitted only through the physical MIDI Out port. It is not echoed to USB MIDI.

Scenes FAQ

FAQ: Do I Need to Use Scenes and Channels?

You can enjoy the AM4 without needing to understand Scenes or Channels. Even if you don't go beyond one preset, you can use the FX very much like traditional gear. Keep in mind, however, that Scenes and Channels are *always there* whether you rely on them or not. They're like the gears on a multi-speed bike: you can ride and never change gears, but they're still there. In the same way, you're always using at least one scene, and every effect is set to one of its four channels. So technically, you're always using Scenes and Channels, but you don't really need to know much about them unless you want to take it to the next level.

FAQ: Why does editing an Effect change every Scene?

It doesn't—it affects every scene that uses that same channel.

If you want an effect to have different settings in a different scenes, you'll need to set it to different channels in different scenes.

Each block always operates on one of its four Channels—A, B, C, or D. When you change settings for that Channel, all Scenes using it will reflect those changes.

To make different settings for different Scenes, switch the effect to another Channel before editing. Changes will then apply only to the Scenes using that Channel.

Remember, each effect has four Channels, and there are four Scenes, so you can create unique settings for every Scene if desired.

Sharing Channels between Scenes keeps sounds consistent where you want them to match. Because each Channel can also use a different **Effect Type**, you're not just recalling knob positions—it's like having four effects in one.

FAQ: Can I Copy/Paste Scenes?

Yes and no.

AM4-Edit allows you to copy one Scene to another *within the same preset*.

It's not possible to copy Scenes across presets, since Scenes are simply configurations of blocks and settings within a specific preset—and different presets can have different blocks or routing structures.

FAQ: Can I Copy/Paste Channels?

Yes.

AM4-Edit allows you to copy and paste Channels within or between presets.

Inside any block, you can copy Channel A, B, C, or D to another Channel—or to ALL Channels at once. You can also copy a Channel to the clipboard and paste it into the same block type in another preset.

For the **Amp block**, AM4-Edit provides finer control: you can copy the entire Channel, or just the **Amp section** or **Cab section** individually.

FAQ: How do Modifiers work across Channels?

Modifiers allow remote control and automation. Learn more on [p. 41](#).

On the AM4, a Modifier applies to **all Channels** of the block where it is assigned. For example, if you link an expression pedal to control Mix in one Channel, that same pedal will control Mix in every other Channel of that block. It isn't possible to assign a Modifier to only one Channel.

Be aware that some effect types within a block have parameters that others don't. In these cases, a Modifier may have no effect or could control a different parameter. For example, a modifier on the highest band of a **7-band Graphic EQ** won't control the highest band of a **3-band Graphic EQ** if a channel changes the effect type.

Channels Tutorial

This section continues the [“Preset Tutorial” on page 30](#).

If you haven't done so already, please complete that section before continuing.

Set Up Channel B in the Amp Block

- ▶ Change to **Amp Mode** (footswitches 2+3 at the same time).
- ▶ Change to **Channel B** by pressing **footswitch 2**.
- ▶ Press **PAGE LEFT** to go to the **Amp Types** page.
- ▶ Turn **SELECT** or **knob A** to select “1987X Treble” and press **ENTER**.
- ▶ Press **Page Right** to show the basic settings for the amp.
- ▶ Dial in Gain, Bass, Mid, Treble, Presence.
 - You can change between amp channels A and B to compare levels.
- ▶ **SAVE** the preset when you're done (Save, Enter, Enter).
- ▶ You can optionally dial in Amp channels **C** and **D** for practice.

Set Up Channel B in the Drive Block

- ▶ Change to **Effects Mode**.
 - Press footswitches 1+2 at the same time, then tap switch 3.
- ▶ Press and hold the **Drive** footswitch to open its **Channel Picker**.
 - Channel A should be active—it is lit and marked with a white dot.
 - Press **footswitch 2** to select **Channel B**.
- ▶ Press **ENTER** to edit the Drive.
- ▶ **Page Left** to go to the type picker.
- ▶ Turn **SELECT** to highlight the “**Klone Chiron**” type and press **ENTER**.
 - That's a smooth, transparent overdrive that adds push a natural push without overly coloring your amp's tone.
- ▶ **Page Right** to show the settings for the Drive. Dial it in however you like and press **EXIT** when you're done. You can use the first footswitch to turn the effect on or off while you work.
- ▶ **SAVE** the preset when you're done (Save, Enter, Enter).
- ▶ You can optionally dial in Drive channels **C** and **D** for practice.

Now continue to the Scenes Tutorial in the next column.

Scenes Tutorial

Set Up Scene 1

- ▶ Change to **Scene Mode** and select **Scene 1** by tapping footswitch 1.
- ▶ Change to **Effects Mode**: Press footswitches 1+2 at the same time, then tap switch 3.
- ▶ Press and hold the **Drive** footswitch to open its **Channel Picker** and set it to Channel A.
- ▶ If any effect isn't on **Channel A**, press and hold its footswitch to open the **Channel Picker**, then it to Channel A.
- ▶ Tap the footswitches to turn **Drive** and **Delay OFF**, and the **Reverb On**.
- ▶ Save the preset by pressing **SAVE**.
- ▶ Turn **SELECT** to the “**S1 Name**” row and use knobs **A–D** to enter the name “**AC Verb**”.
- ▶ Press **ENTER** twice to save the changes.

Set Up Scene 2

- ▶ Change to **Scene Mode** and select **Scene 2** by tapping footswitch 2.
- ▶ Change to **Effects Mode**: Press footswitches 1+2 at the same time, then tap switch 3.
- ▶ Press and hold the **Drive** footswitch to open its **Channel Picker** and set it to Channel B.
- ▶ Use the footswitches to turn **Drive** and **Delay ON**, and the **Reverb OFF**.
- ▶ Save the preset by pressing **SAVE**.
- ▶ Turn **SELECT** to the “**S2 Name**” row and use knobs **A–D** to enter the name “**AC Drive FX**”.
- ▶ Press **ENTER** twice to save the changes.

Set Up Scene 3

- ▶ Change to **Scene Mode** and select **Scene 3** by tapping footswitch 3.
- ▶ Change to **Effects Mode** and use what you have learned to set the **Amp** to Channel **B**.
- ▶ Turn on all of the FX. You may set their channels as desired.
- ▶ **Save** and **name** this scene.

Set Up Scene 4

- ▶ Use what you've learned to set up Scene 4 as desired.
- ▶ Practice using **Scene levels** to adjust the overall volume of Scene 4.
 - Press **Home**, then Press **Page Right** 2x to show the **Main Levels** page.
 - Use **Select** and **Knob A** to adjust **Scene 4 Level**.
- ▶ **Save** and **name** this scene.

Tutorial Complete!

- ▶ Change to **Scenes Mode** and try out all four scenes using the footswitches.

Modifiers

Modifiers are one of the most exciting features in the world of Fractal Audio. They allow effect parameters to be remote-controlled or automated in real time. With modifiers, the creative possibilities are practically limitless: control the sweep of a volume pedal, wah, or whammy, the rate of a modulation effect like phaser or rotary, the gain of a drive, the input gain ("send level") of a reverb or shimmer, and more.

Starting simply, you might assign a connected expression pedal. Digging deeper, you'll discover other "sources" to use instead of pedals: every preset has its own LFO, Envelope Follower, Sequencer, Pitch Follower, and an ADSR "envelope generator". You can also use a MIDI CC# message via an "External Controller."

Modifiers let you define both the range ("min" and "max") for the target parameter. For example, a reverb mix could range from 0-100% or be restricted to 25-40%. Advanced users can further customize with detailed curves and additional options. Modifiers can be stacked, allowing a single pedal to control multiple parameters, such as delay feedback, mix, and more at the same time. Each preset supports up to 16 modifiers in total.

Modifiers are easy to use but offer fantastic potential for those who want extreme creativity or control.

Where Modifiers Can be Used

Most but not all parameters allow you to add a modifier. Parameters that support modifiers are marked with a yellow circular symbol (illustrated below). When a modifier is already assigned, the circle appears solid, like a yellow LED that's turned ON. This symbol can appear on knobs, switches, text parameters, sliders, or any other type of control.

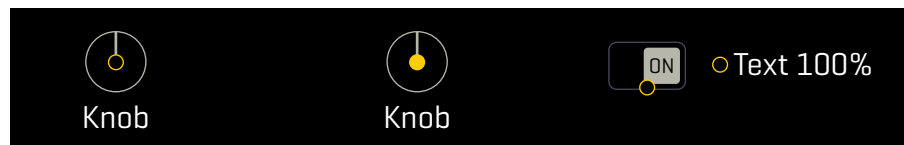

The open circle means you can add a modifier here.

The filled circle means a modifier is already present.

Here, a switch and a text parameter allow modifiers.

CREATE A MODIFIER

- ▶ Select any parameter that supports a modifier. Look for the yellow circle.
- ▶ Press the **ENTER** button to show the **Modifier** screen
- ▶ On the Modifier screen select the **Source** you want to use to control the parameter – for example, "PEDAL 1". The basic modifier page also allows you to:
 - ◻ Select a **Source** to control your parameter. (Learn more on the next page.)
 - ◻ Set the **Range** for the parameter being controlled. For example, a volume pedal might range from 0.0 (silent) to 10.0 (max), or it might be limited to 8.0–10.0, going from "slightly dialed down" to "full on."
 - ◻ You might want to set up **Auto-Engage** ([p. 42](#)) which activates the effect when the modifier is used.

NOTE: Auto-Engage disables normal ON/OFF footswitch control of the effect, but eliminates the need for an extra "stomp" or separate "toe switch".
 - ◻ You can adjust the **Performance** "Update Rate". The "Fast" setting can sound smoother but uses more CPU.
- ▶ Press **EXIT** to leave the modifier menu.
- ▶ **SAVE** the preset to save the modifier.

EDIT OR REMOVE A MODIFIER...

To edit an existing modifier, use the process above for creating a modifier.

To remove a modifier, simply change its SOURCE to "NONE".

FAQ: Why Can't I Change a Setting once it has a Modifier?

You can't manually adjust a parameter that is under the control of a modifier. Modifiers are shared across all channels, so plan accordingly.

In the event you want to remove a modifier and can't find it, or when a modifier on one channel causes unexpected results on another, you can find a list of all modifiers in the current preset in the Controllers menu. See [p. 45](#).

Modifier Settings

The Modifier screen contains settings to control how the modifier works.

Source

The Source is the controller that drives a modifier. There are 12 options:

- **Pedal 1, 2** – Use these to assign pedals or switches connected directly to the AM4. (See [p. 10](#) for instructions on Pedal/Switch initial setup).
- **External 1, 2, 3, 4** – External Controllers allow you to assign MIDI CCs as modifier sources. They can also be set globally to either of the onboard PEDAL jacks. To assign a CC or pedal globally to any of the 4 External Controllers, open SETUP > MIDI Remote, scroll down using SELECT, and then turn A to assign the desired value.
- **LFO A, LFO B, ADSR, Sequencer, Envelope** – The AM4 includes four “Internal Controllers” that can be used as modifier sources. Settings for these sources can be found in the **Controllers** menu ([p. 45](#)) and are saved independently in every preset.
- **Pitch** – The Pitch Detector analyzes the pitch of your playing and outputs a low value for low notes and a high value for high notes. It is keyed to the lowest and highest notes on a standard 6-string guitar.
- **None** – Assigning this controller removes the modifier from a parameter.

Parameter Range

The Range settings define **Min** and **Max** points for how the target parameter responds to the source. These allow you to fine-tune sound changes.

EXAMPLE 1: A pedal assigned to **Delay Feedback** has **Min** at “10%” and **Max** at “50%”. The feedback sweeps only from 10% to 50% as the pedal is moved, even though this parameter normally ranges from -100% to +100%.

EXAMPLE 2: The modifier for a pedal controlling **Rotary Rate** has **Min** at “0.67 Hz” and **Max** at “6.5 Hz” (classic “chorale” and “vibrato” speeds for a Leslie) even though this parameter normally ranges from 0 Hz (parked) to 10 Hz.

Auto-Engage

Auto-Engage engages or bypasses a block when the **Source** value changes. If you’ve ever used a Wah without a toe switch, you’ll easily understand the concept: the Wah automatically activates when you push it forward and bypasses when you pull it back. Auto-Engage works the same way but can be applied to any modifiable parameter in any effect. Once you try it, you might find it conveniently eliminates the need for expression pedal toe switches.

Auto-Engage has two settings:

Auto-Engage – This sets the auto-engage “mode”.

- Choose **“OFF”** to disable Auto-Engage.
- **POSITION (“POS”)** options trigger the effect based on **OFF VALUE** (see below).
- **SPEED (“SPD”)** options engage the effect when the controller is moved quickly.
- The **FAST, MEDIUM** and **SLOW** options determine how quickly the effect turns ON or OFF once Auto-Engage is triggered.
Use SLOW to “relax” Auto-Engage, so it doesn’t switch off too suddenly.

Off Value – Sets the threshold that the source must cross for auto-engage to occur. If Off Value is below 50%, the effect bypasses when the controller goes below the threshold. If it’s set to 50% or higher, the effect bypasses when the controller goes above the threshold.

For “heel down = bypassed,” set to 5%. For “toe down = bypassed,” use 95%.

Performance

Update Rate controls how often the modifier is refreshed. The setting of slow is in fact still very fast, and fine for the vast majority of applications. The faster settings require additional CPU but provide even smoother sound performance when ultra fast changes are required (while using a fast LFO on a filter, for instance). Adjust this setting if you think you hear “zipper noise” while a modifier is in use.

Expert Options

Just like effects, Modifiers also offer “Expert” editing ([p. 23](#)).

The next page covers these additional options.

Expert Modifier Settings

Modifiers also support “Expert” editing (p. 23). To show the Expert settings for any modifier, first display its basic Modifier page, then switch to Expert mode by pressing **Page Left** and **Page Right** at the same time. All of the basic Modifier settings (previous page) appear in expert mode, along with the following:

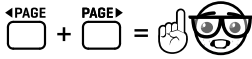

Custom Modifier Curves

Start, **Mid**, **End**, **Slope**, **Scale**, and **Offset** are used to create custom curves which re-map the relationship between the modifier source and the value of the target parameter. A **graph** shows the relationship between the source (x-axis) and the parameter (y-axis). The dot on the graph tracks the source.

The default settings (first graph below) create a 1:1 linear relationship (the blue line) between source and parameter. As the source changes, the parameter tracks it directly.

The other examples below show examples of the kinds of shapes and curves you can create using Start, Mid, End, Slope, Scale, and Offset.

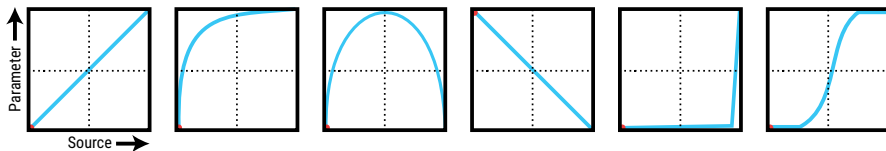

Damping

Attack and Release: These values apply “damping” to slow the rate at which the target parameter value chases the source. **Attack** determines the rate of change as the source is increased, and **Release** controls the rate as it decreases. At low settings, these add just a little smoothing. Try settings of about 10 ms to “relax” a pedal or to ease the edges of a square LFO to eliminate clicks and pops. Higher settings can cause sound changes to be extremely slow and lazy.

PC Reset

PC Reset allows you to set a specific value for an external controller when a preset first loads. This feature temporarily overrides the actual position of the external controller until it is physically moved or updated.

Here’s how it works:

- ▶ While setting up a modifier, turn PC Reset to “ON.”
- ▶ Save the preset.
- ▶ Return to editing the effect and locate the parameter that has the modifier applied. Normally, you wouldn’t be able to adjust the value of that parameter directly. However, with PC Reset turned ON, you can set and save a specific value.
- ▶ This value will be used when the preset loads, until the external controller (like a pedal) is physically moved, which then updates the parameter.

Modifier Tips & Tricks

- ▶ The same source can be assigned to **multiple modifiers** at the same time. For example, one pedal might adjust Chorus Rate and Chorus Depth at the same time – even in different ways.
- ▶ Modifiers use a very small amount of **CPU** power while you use them. Test any presets which seem close to the edge.
- ▶ In addition to Auto Engage, you can also assign modifiers to the **Bypass parameter**.
- ▶ The LFO, Sequencer, and ADSR are used as modifier sources, but these also have parameters of their own which can be controlled by a modifier. For example, an expression pedal can control the rate of the Controller LFO. An Envelope can turn the Sequencer on or off. The potential for creative sound design is immense!
- ▶ The last page of the Controllers menu contains a **list** of all of the modifiers used in the current preset. When you select one of these, you can press ENTER to open that modifier for editing.

Modifier Tutorial: Wah

This tutorial will help you learn to create a modifier. If you've already set up an expression pedal for use with your AM4, you can use that pedal here. If not, you can add one using the instructions on [p. 10](#), or use the option below to create an "LFO wah" instead, requiring no pedal.

1. Select any preset that does not already contain a Wah block.
 - To select a preset, enter **Preset Mode**, turn **Knob A**, and press **ENTER**.
2. Turn **SELECT** to highlight an effect slot to the left of the Amp where you want to place the Wah.
3. Turn the Type knob below that slot to "**WahWah**" and press **ENTER**.
4. Press **ENTER** again to **EDIT** the Wah.
5. Select a **type** such as "Cry Babe" and press **ENTER** to confirm.
6. Press **Page Right** to view the settings for the Wah.
7. Select the top row of controls, then turn **Knob A** to highlight "Wah Control." (It will appear in blue.) Notice the **open** yellow Modifier indicator in the center of the knob.
8. Press **ENTER** to show the **Modifier** screen.
9. The "Source" setting will be highlighted. Turn **Knob A** to select "**Pedal 1**". (Option: You can also use "**Pedal 2**" if you have it set up, or if you don't have a pedal, try "**LFO A**".)
10. Test your pedal. You should hear the wah working, and see the dot moving on screen while you move the pedal.

OPTIONAL: If you want the Wah block to bypass automatically when you move the pedal to the heel position, change "Auto-Engage" from "OFF" to any of the other options, such as Medium Position ("MED POS").

11. Press **EXIT** return to the Wah edit menu. Notice the **solid** yellow Modifier indicator in the center of the knob.
12. **SAVE** your preset if you want these changes to be permanent by pressing Save, Enter, Enter.

NEXT STEPS: TRY A SEQUENCER WAH

1. Start with the preset you created using the tutorial in the left column.
2. On the **HOME** page, turn **SELECT** to highlight the Wah.
3. Press **ENTER** to edit the Wah.
4. Find and highlight the "**Wah Control**" knob, then press **ENTER** to open the modifier screen.
5. Change the source to "**Sequencer**". The sequencer is one of the on-board controllers that can be programmed independently in every preset. We'll adjust it in a moment...
6. Scroll down on the Modifier page and make sure **Auto-Engage** is set to "OFF".
7. If your Wah is bypassed, turn it on now using the appropriate footswitch.
8. Now let's edit the sequencer. Press **HOME** and then press **Page Right** 8x until you land on the **Controllers** page.
9. Press **ENTER** to open the **Controllers** menu.
10. Page to the **Controllers > Sequencer** page.
11. Select the top row. Change **Run** to "RUN". Set **Steps** to "8"
12. Select the 2nd row. Use Knobs **A-D** to set **Steps 1-4** as desired.
13. Turn **SELECT** one click to the right, then use Knobs **A-D** to set **Steps 5-8** as desired.
14. You can continue to explore the Sequencer, or press **HOME** when finished.
15. **SAVE** your preset if you want these changes to be permanent by pressing Save, Enter, Enter.

The Controllers Menu

The Controllers menu contains **Internal Controllers** provided for use as modifier sources. It also provides access to preset **Tempo** settings.

To view or edit these Internal Controllers:

- ▶ Load the desired Preset
- ▶ Press **Home**, and then press **Page Right** six times to **CONTROLLERS**.
- ▶ Press **ENTER** to open the Controllers menu
- ▶ You can page left and right to access **Tempo**, **LFO**, **Envelope Follower**, **ADSR** (Envelope Generator), **Sequencer**, and the **Modifiers** overview for the current preset.
- ▶ Press **HOME** or **EXIT** at any time to exit the Modifiers menu.
- ▶ If you want to save your Controller changes, save the entire Preset.

Controllers > Tempo

The Tempo page allows you to view or change the tempo, change tempo settings for the current preset, and turn on a metronome to use for practicing.

Tempo – Sets a specific tempo such as 90 beats per minute (BPM).

TIP: While you're on this page, the **ENTER** key allows you to tap the desired tempo. The Tap Tempo feature has two modes: "AVERAGE" – which results in smooth changes over multiple taps and "LAST TWO", which sets the tempo instantly after just two taps. You can choose the desired option in **SETUP > Global Settings > Tap Tempo Mode**.

Tempo To Use – Determines how the AM4 behaves when the preset loads. The choices are:

- **GLOBAL TEMPO:** The Global Tempo value is a system setting independent of any preset or effect. When you load a preset with this setting, the tempo does not change from whatever it was previously.
- **PRESET TEMPO:** When you load a preset with **Tempo To Use** set to "PRESET," the saved Tempo value takes over.
(Note: The Global Tempo remains set in the background and will be used when you load a different preset with "Tempo To Use" set to "GLOBAL.")

Metronome – Adjusts the level of a built in metronome, handy for practicing.

Controllers > LFO (A/B)

An **LFO** (Low-Frequency Oscillator) generates a slow, repeating signal that can modify various aspects of a sound. Common examples include the pulse of a tremolo, the sweeping motion of a phaser, or the random filter effect heard in Frank Zappa's "Ship Ahoy." The Internal Controller LFO can be assigned as the source for any modifier, enabling you to craft a wide range of interesting effects. It offers the following settings:

Rate, Tempo – You can manually set the rate in Hertz, or synchronize it to a rhythmic value in time with the AM4's tempo.

Depth – This controls the amplitude, or intensity, of the LFO, adjusting how prominently it affects the sound.

LFO Type – Sets the waveform shape. Options include classics like Sine, Triangle, Square, Saw, and Random, as well as more specialized shapes like Log, Exponential, and Astable, which simulates certain analog LFOs.

Duty and **Shape** – These alter the waveform in distinctive and useful ways. Adjusting the Duty of a Square wave, for instance, controls the proportion of time that the waveform stays in its "high" state versus its "low" state during each cycle. The best way to understand these controls is to observe the waveform graph while making adjustments.

High Cut – This filters the waveform, smoothing out aspects of its shape.

Quantize – This converts smooth waveforms into stepped ones. For example, applying Quantize to a Triangle waveform will change its smooth, continuous rise and fall into a series of distinct "terraces".

Run – Starts and stops the LFO. This can be used to assign a Pedal/Switch or Envelope Follower to trigger the LFO, or to start/stop it via MIDI, ensuring perfect alignment with a track.

Output B Phase: The LFO outputs two signals, and you'll see **LFO A** and **LFO B** listed in the modifier sources. You can use this control to change the Phase of output B with respect to A.

Controllers > Envelope Follower

The Envelope Follower generates a control signal based on the dynamics of your playing. You can fine-tune its sensitivity and response time, making it ideal for “touch” effects that react to how hard or soft you play.

You can independently set **Attack** and **Release** times, adjust the trigger **Threshold**, and control the input **Gain**. Additionally, **Low Cut** and **High Cut** filters let you shape the response without altering what you hear. A meter shows the response in realtime while you play.

Controllers > ADSR

The ADSR controller is an envelope generator. Once triggered, it changes its output value over time with adjustable settings for **Attack**, **Decay**, **Sustain**, **Sustain Level**, and **Release** (“ADSR”). A graph visually represents the effects of these settings as you make adjustments.

The ADSR is triggered when the signal level surpasses a set point called the **Threshold**. A Type parameter lets you choose between Linear and Exponential curves. You can observe the graph to see how these settings affect the envelope.

The ADSR has three modes—**Once**, **Loop**, and **Sustain**—and can optionally be set to **Retrigger** every time the signal level goes above the set point, rather than needing to play all the way through before retriggering. Unlike the **Envelope Follower** (above), the ADSR envelope generator produces the same control signal each time, but only triggers when you play with enough intensity.

Controllers > Sequencer

The **Step Sequencer** brings rhythm and movement to a sound by creating control patterns. **Rate** and **Tempo** allow you to define the speed of your sequence, while **Stages** lets you select the number of steps in the pattern. Use the **Run** switch to start or stop the sequence, and the **Step** button to advance the sequence manually. Finally, **Damping Time** smooths the transitions between stages, giving your pattern a more fluid, less abrupt feel.

Controllers > Modifiers

The last page of the Controllers menu is the Modifiers list, which displays all the modifiers in the current preset. You can edit any modifier in this list by selecting it and pressing ENTER. Each preset can include up to 16 modifiers, but remember that each one also demands a tiny slice of CPU!

Pitch Detector

The **Pitch Detector** is available as a Source for modifiers, though it doesn't appear in the **Controllers** menu since it has no adjustable parameters. It analyzes the pitch of your playing, outputting a low value for low notes and a high value for high notes, calibrated to the range of a 6-string electric guitar in standard tuning.

External Controllers

External Controllers are also Modifier Sources, but they need to have a control source assigned to them in order to function. For each of the four External Controllers, you can globally assign PEDAL 1, PEDAL 2, or any MIDI CC# message.

For example, if you want to use MIDI CC#11 to operate a Wah effect, you would first assign “CC#11” to **External 1** in global SETUP, and then use External 1 as the Source of a modifier controlling the Wah.

While this proxy method is indirect, it has several advantages. First, it allows you to share presets between those who use different pedals in different ways, providing an easy way to make global changes instead of editing every preset. One person might use PEDAL 1 as a Global Volume while another uses it for Wah, Whammy and other flexible scenarios. Yet another might connect a MIDI controller with its own onboard pedal that transmits CC#11.

External Controllers assigned to MIDI are given a value of “0” until some MIDI data is received to change them. The External Controller Initial Value parameters can change the startup value for a MIDI controller to any value. Then, when the AM4 is powered on, any modifiers assigned to the missing controller will be at the desired value instead of at 0.

Find the options to assign and set the initial value for External controllers in the **SETUP > MIDI/Remote** menu.

Firmware Updates

Firmware is the internal software that runs your AM4, similar to an operating system. It is identified by version numbers such as 1.00, 1.01, etc. Firmware updates add new features, updates, and fixes and are an exciting part of owning a Fractal Audio Systems product.

UPDATING FIRMWARE

- ▶ Open **AM4-Edit** on your computer (p. 16). The app automatically connects to your AM4 when it is powered on and connected via USB.
 - Note: Windows users also need to install the AM4 Driver.
- ▶ **Fractal-Bot** is built into AM4-Edit and can be found under the Tools menu. Fractal-Bot will automatically detect when there is an available firmware update.
- ▶ Follow the easy on-screen instructions to **send the update**.
 - Please read any included Release Notes. These will let you know what's new and alert you to anything to be aware of before upgrading to the new version.
- ▶ After file transmission is complete, watch the AM4 for instructions to power off, wait 5 seconds, and then power on again.
- ▶ You can verify that the upgrade worked by checking the installed version. Open **SETUP > System Info**.

NOTES

- Some firmware updates include two parts: the main firmware, and a separate **DynaCabs** update. In these cases, Fractal-Bot shows a window with special instructions.
- Firmware updates will occasionally be accompanied by new versions of the **Factory Presets**. These will be available separately and can also be installed using Fractal-Bot.
- Besides automatic updates, you can also **manually download** firmware from the **Support > Downloads** section of our web site.
- If you already have the latest firmware version installed but want to **re-install** it for any reason, hold **Cmd** (Mac) or **Ctrl** (Win) and **re-select** the AM4 under step 1 in Fractal-Bot.

The Setup Menu

The Setup menu contains various global settings, options, utilities, and information, with pages for **Audio, Pedals, Footswitches, MIDI/Remote, Settings, Reset, and System Info**.

OPEN THE SETUP MENU

- ▶ Press **ENTER** and **EXIT** together.
- ▶ Use **PAGE LEFT** and **PAGE RIGHT** to navigate the menu.
- ▶ Press **EXIT** to go back to wherever you came from.



- ⌚ Changes in SETUP are stored automatically as you make them. When this happens, the title bar of the AM4 will display **"SAVING..."**. Do not power off while the AM4 is saving, or your most recent changes could be lost.

The pages that follow contain a complete reference detailing every page and option in the Setup menu.

SETUP > Audio

PARAMETER	Description
Input Meter Input Pad 0, 6 dB, 12 dB, 18 dB	<p>This meter shows the audio level in the AM4 after the Input Pad (see below). The meter turns red when input clipping occurs.</p> <p>The Input Pad setting can be adjusted from 0 dB (for low-level input signals) to 6 dB, 12 dB, or 18 dB (for progressively louder input signals). The default Input Pad setting is 12 dB, which is ideal for guitars with hot pickups. When the input clips, the words "IN CLIP" also appear in red in the title bar of the main display, indicating the need to increase the pad setting.</p> <p>IMPORTANT: <i>You will not hear any difference in level as you adjust the Input Pad. The AM4 adds compensation so your guitar is processed at the same level it would be when connected directly to an analog amp or pedal.</i></p> <p>Automatic Input Pad Adjustment: If the input of the AM4 clips persistently, the unit will automatically increase the Input Pad setting. When this occurs, the word "Auto" will appear next to the Input Pad value, for example: "12 dB (Auto)" indicating that the pad was automatically increased to 12 dB. When you reboot the AM4, the automatic setting is cleared, and the last manually selected value is restored. If you want to make the automatic pad setting permanent, just turn the Input Pad knob one "click" to clear "Auto" and set the desired value.</p> <p><i>If the input still clips with the pad setting at 18dB, decrease the output level of the device(s) connected to the AM4 input(s).</i></p>
Input Source Analog, SPDIF, USB 3/4	<p>Sets the input source, selecting between Analog (the onboard jacks), SPDIF (the onboard SPDIF IN connector) or USB Channels 3/4, which appear as outputs on a connected computer. See p. 15 for more on USB.</p> <p>Connect only 48k streams to the SPDIF input, as the AM4 will automatically derive its 48k clock signal from the detected input.</p>
Output Mode STEREO, SUM L+R, COPY L -> R, MUTE, SPLIT	<p>This setting determines how signal is processed at the analog outputs. This control makes it easy to use the same presets in a variety of stereo and mono environments. USB and SPDIF Audio goes directly to the converters in stereo and is NOT affected by this setting. The option "MUTE" is available in case you want to eliminate analog audio from the AM4 while using it with a DAW. The SPLIT option is for special setups for simultaneous use of FRFR and power amp/guitar speaker. See p. 20</p> <p>See Mono vs. Stereo on p. 13 for more on how the AM4 processes audio internally.</p>
Output Phase NORMAL/INVERT	<p>Determines whether signal at the output will be normal or phase-inverted relative to the actual output of the input or effects. You can use this in a pinch to correct phase inversion problems elsewhere in your setup.</p>
USB 1/2 & 3/4 Level -40.00 – + 20.00 dB	<p>The USB 1/2 Level and USB 3/4 Level parameters adjust USB playback levels from -40 to +20 dB. While computer audio playback levels are typically set on the computer itself, these controls are useful when you need an additional boost or cut.</p>
SPDIF In Level	<p>This boosts or cuts SPDIF input signals, allowing you to adjust the level before processing.</p>

SETUP > Footswitches

The footswitch page allows you to designate how Press & Hold works on the AM4. Note: The default “Gig Mode” (see [p. 6](#)) has a press and hold function on every footswitch. This causes effects and other tap functions to fire when you release the switch instead of when you tap it. You can completely disable all press and hold function, or even assign custom functions using **Press & Hold Mode**, below.

PARAMETER	Description
Tap Amp in FX Mode	Determines what happens when you tap the footswitch for the Amp block in FX Mode: Nothing , Bypass , or toggle the amp Out Boost .
Tap Current Channel in Amp Mode	Defines what happens when you tap the footswitch for the current channel while in Amp Mode: Nothing , or toggle the amp Out Boost .
Press & Hold Mode	Selects between available options for global press and hold footswitch functions. Disabled – Disables all press and hold functions. Every operation must be executed using the knobs, buttons, and tap switches. Gig Mode – Selects a ready-to-play set of custom press-and-hold functions. See p. 6 for full details. Custom Mode – Allows you to select between various options for press and hold on the four switches.
Hold Timeout 0.25 – 2.00 Seconds	This sets the time limit before any Hold function is fired, beginning from the moment the switch is depressed. When a Hold function is assigned, a Tap function fires if the switch is released before the press and hold timeout elapses.

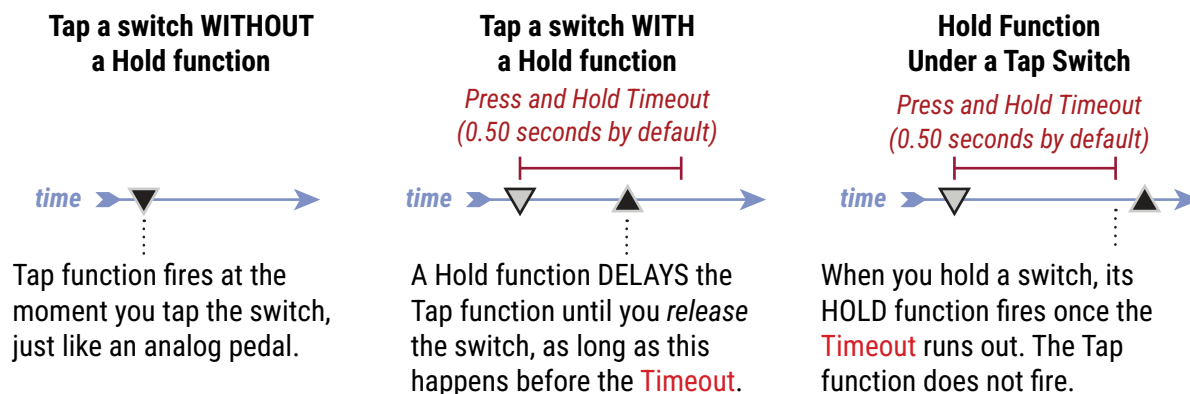

- Custom Press & Hold 1** These four parameters provide the option to assign optional global Press & Hold functions to the four footswitches of the AM4.
- Custom Press & Hold 2** These options are shown when Press & Hold Mode is set to “CUSTOM”. IMPORTANT: Any custom assignment is global across every mode.
- Custom Press & Hold 3**
- Custom Press & Hold 4**
- ▶ **Disabled** – The selected footswitch has no hold function. Its tap function fires at the moment the switch is depressed.
 - ▶ **Mode Select** – The mode select screen is displayed, just as if you had pressed HOME + SAVE.
 - ▶ **Preset Mode, Scene Mode, FX Mode, Tuner Mode, Amp Mode** – The AM4 changes to the designated mode.
 - ▶ **Bank +1, Bank -1** – The AM4 switches to the next or previous bank. When you change banks, the same preset number from the new bank is automatically loaded (e.g., if C3 is selected and you switch to Bank D, D3 will load).
 - ▶ **Preset +1, Preset -1, Scene +1, Scene -1** – The AM4 switches to the next or previous Preset or Scene.
 - ▶ **Channel Picker** – Shows the 4-button “Channel Picker” for the corresponding effect. For example, if this function is assigned to switch 3, holding Switch **3** = will show the channel picker for the effect in slot **3**.

SETUP > Pedals

PARAMETER	Description
Pedal 1 Type Pedal 2 Type	<p>Set this according to whether you have connected a pedal or a certain type of footswitch:</p> <p>EXPRESSION PEDAL: Choose this option when using an expression pedal such as the Fractal Audio EV-1 or EV-2. Third-party pedals should have a linear resistance taper and a maximum resistance between 10–100kΩ. Expression pedals must be connected with Tip-Ring-Sleeve (TRS) cables.</p> <p>Each pedal jack can also support one switch, but dual switches are not supported.</p> <p>SWITCH (Momentary, Virtual Toggle): Forces a connected momentary switch to behave like a latching/toggle switch.</p> <p>SWITCH (Any, Follow Hardware): Use this when connecting a latching switch, or a momentary switch and want momentary “action.”</p>
Calibrate PEDAL 1 Calibrate PEDAL 2	<p>These options allow you to calibrate expression pedals connected to an onboard Pedal jack.</p> <ul style="list-style-type: none"> ▶ Select the appropriate option and press ENTER. ▶ Move the pedal through its full range of motion several times. The meter will show the actual response of your pedal, which does NOT need to fully reach the top or the bottom but should show motion across the majority of the range. ▶ Press ENTER again when finished. ▶ The mini-graph on the main Pedals page now shows the output of your calibrated pedal. If it does not range from 0-100, calibrate again or check your cable, pedal, etc. <p>Remember: Switches, unlike pedals, do not need to be calibrated but should still display 0-100 on the mini-graph.</p>

SETUP > MIDI/Remote

PARAMETER	Description
MIDI Channel 1–16, OMNI	Sets the channel on which the AM4 will receive MIDI messages. "OMNI" causes the unit to respond to incoming messages on <i>all</i> channels.
MIDI Thru Off, On	This enables or disables MIDI Thru , which causes messages received at the MIDI In port to be merged with any internally generated MIDI data at the MIDI Out port.
Receive MIDI PC ON/OFF	Determines whether the AM4 will process or ignore incoming MIDI Program Change messages.
Send MIDI PC 1–16 OMNI OFF	Determines whether or not the AM4 will automatically transmit a MIDI Program Change message at its MIDI OUT port when a new preset is loaded. This is the easiest way for most people to operate a single connected MIDI device while changing presets on the AM4. Any custom MIDI mapping is left to the downstream device. To use this feature you simply select which channel you want the message to be transmitted on. The "OMNI" setting transmits the message on <i>all</i> channels.
Ignore Redundant PC ON/OFF	This setting determines whether the AM4 should re-process or ignore a Program Change message that corresponding to the current preset. With this setting "OFF", a preset will be reloaded—all changes discarded—when it is selected again via PC. This allows you, for instance, to load a preset, use footswitches to toggle effects, and then reload the preset to have it revert to its saved state.
Scene Select	<p>This feature allows you to choose specific Scenes based on the value of a MIDI CC message sent to the AM4. The value refers to the data associated with a particular MIDI CC# message, not the CC# number itself. For example, if you assign MIDI CC#17 to control Scene Select, the value sent for CC#17 (ranging from 0 to 127) determines which Scene is loaded:</p> <p>0 = Scene 1 2 = Scene 3 1 = Scene 2 3 = Scene 4</p> <p>The series continues, cycling through scenes 1–4 for the remaining values.</p>
Scene +1, Scene -1	These two settings allow you to step up or down through the Scenes of the current preset using MIDI CC# messages.
Send Scene Sync Channel, Send Scene Sync CC#	<p>Scene Sync sends a MIDI CC message automatically when you change the scene on the AM4. It's a simple global option for syncing scene changes between Fractal Audio products or other MIDI gear, not to be confused with the more customizable Scene MIDI feature found in every preset (see p. 38).</p> <p>To use Scene Sync, select the desired MIDI Channel and CC#. Each time you change scenes, the AM4 sends the selected CC number on the chosen channel. The CC value equals the scene number minus one (Scene 1 = 0, Scene 2 = 1, etc.).</p> <p>Scene Sync works with scene changes from footswitches, the Scene Picker, incoming MIDI, or AM4-Edit. No Scene CC message is sent when you change presets, because each preset on a connected Fractal Audio product automatically loads its own Default Scene upon preset change.</p> <p>When using this feature with another Fractal Audio product such as the VP4, set its Scene Select setting to match the Scene Sync CC set on the AM4.</p>

SETUP > MIDI/Remote (Continued)

PARAMETER	Description
Input Volume	These individual parameters allow you to globally control the input or output levels of the AM4.
Output Volume	
Amp Block Out Volume	
	Use these for convenient global Volume without needing to “waste” one of the effects on a Volume block.
	The Amp Block Out Volume feature is unique to the AM4. Use it to adjust the output volume of the amp without the need for an additional Volume block between the amp any time-based effects. Because this volume is scaled at the output, it does not affect amp gain or tone.
Amp Out Boost	Provides a way to remotely engage the amp post boost feature.
Tap Tempo	Provides the ability to tap the tempo using an external switch. Learn more about Tempo on p. 14
Tuner	Provides a way to remotely enter or exit the Tuner.
Tuner on Heel Down	You can set the AM4 to automatically display the tuner when the designated Pedal or MIDI CC is in the “Heel Down” position ($\leq 5\%$). This feature works best when the same controller is also assigned to Input Volume or Output Volume , allowing the tuner to pop up when you turn the volume down.
FX 1,2,3,4 Bypass	These four options allow you to use external switches or MIDI messages to bypass or engage the four FX of the AM4.
FX 1,2,3,4 Channel	These options let you use MIDI messages to select channels for the four block slots on the AM4, or to dedicate a CC to change the Amp Channel. The first four settings are <i>positional</i> —they affect whichever block occupies that slot. The Amp Channel option, however, is <i>directly linked</i> to the Amp block wherever it’s placed. (This differs from the VP4 design, and was added to support simpler external controllers for amp channel changes.)
Amp Channel	
	IMPORTANT: Don’t assign overlapping controls. For example, if your Amp is in slot 2 and you assign one CC to “FX2 Channel” and another to “Amp Channel,” both will attempt to control the same parameter. Choose a single method to avoid conflicts.
External 1,2,3,4	External Controllers are Modifier Sources that require data from an input such as a Pedal Jack or a MIDI CC# message to function. For instance, if you want to use MIDI CC#11 to control a Wah effect, you would assign CC#11 to External 1 , then use External 1 as the Source for a modifier in the Wah block.
	Think of an External Controller as a “proxy” that connects your physical or MIDI controller to effect parameters.
	For each of the four External Controllers, you can assign PEDAL 1, PEDAL 2, or any MIDI CC#.
	See p. 46 for more on External Controllers.
Preset +1, Preset -1	These two settings allow you to step up or down through the presets of the AM4 using MIDI CC# messages.
INITIAL VALUE:	These parameters specify the initial value to be used for each of the External Controllers (p. 46) when the AM4 is powered on.
External Control 1–4	This value persists until data is received from a MIDI controller. This is especially useful when an external MIDI controller is absent. For example, if you normally use a MIDI expression pedal to control the volume in your presets, a missing controller might make the preset get “stuck” in a muted position. Setting an initial value of 100% for the External Controller mapped to that MIDI pedal would ensure that when the pedal is not connected, the volume will stay at 100% instead of 0%.
	This setting is only for controllers with a MIDI CC# assignment. It does not apply to locally connected pedals or switches.

SETUP > Global Settings

PARAMETER	Description
Startup Mode	Determines which operating mode the AM4 starts in after power-on—Preset Mode, Scene Mode, Effects Mode, or Amp Mode.
Gapless Changes ON, OFF	On the AM4, preset, scene, and channel changes are gapless by default. The option to turn this feature off is provided because it can help conserve a small amount of CPU resources.
Spillover OFF, DELAY, REVERB, DELAY+REVERB	Allows Delay and Reverb tails to continue ringing out, or “spillover,” when switching Presets . Setting this to “OFF” clears the tail upon preset change. NOTE: Spillover inside of a single preset is automatic and determined by the Bypass Mode. See p. 34
Default Scene AS SAVED, 1–8	When set to “As Saved” the scene selected when recalling a preset is the scene that was active when the preset was last saved. When set to a particular scene value that scene will always be selected when any preset is recalled.
Tap Tempo Mode AVERAGE, LAST TWO	Determines how the tempo is adjusted when tapping the Tempo footswitch, an external tap tempo controller, or the EDIT button on the Controllers > Tempo page. “AVERAGE” is based on the average of the last ten taps, making it more forgiving but resulting in more gradual changes. “LAST TWO” uses only the last two taps, requiring more precise tapping but allowing for quicker tempo changes.
AC Line Frequency 60 Hz, 50 Hz	Certain types in the Noise Gate use smart EMI filtering to reduce hum and buzz. To ensure optimal performance, set this parameter to match the power line frequency of your region: 60 Hz for North America, Taiwan, South Korea, some parts of South America and other regions. 50 Hz for most of Europe, the United Kingdom, Australia, China, India, South Africa, the majority of Asia, and parts of South America. This setting is crucial for the Noise Gate to effectively filter out unwanted noise based on your local power supply frequency.
Noisegate Offset +/- 40 dB	Globally adjusts the THRESHOLD of the Input Noise Gate, raising or lowering it across all presets. If the THRESHOLD for a specific preset is set to “OFF,” the global Offset will have no effect. This can be particularly handy in situations where the overall noise environment changes, such as moving between different venues with varying levels of interference or when swapping between different instruments that might have different noise sensitivity.

SETUP > Global Settings (Continued)

PARAMETER	Description
Power Amp Modeling	Globally enables or disables power amp simulation in all Amp blocks across all presets. Turn this OFF when using the AM4 with a tube power amp that adds its own tone and dynamics. Presence and Depth are disabled, and Master Volume becomes a simple level control. All amp parameters not part of the virtual power amp continue to function normally.
Cab Modeling	Globally enables or disables the Cab section of the Amp block in all presets. Turn this off when using the AM4 with an external amp into a traditional guitar speaker cabinet, as running speaker simulation into a real guitar speaker can sound dark or "blanketed."
Speaker Impedance Curve	Determines how the expert Speaker Impedance Curve is chosen when you change the Amp Type in the Amp block. When set to DEFAULT , the matching impedance curve for the selected amp type is used automatically. When set to any other value, that curve will be pre-selected each time the amp type is changed.
Amp- > Cab Type Linking	Determines whether changing the Amp Type automatically updates the Cab Type to a matching or closely related model. When disabled, the Cab Type remains unchanged when you switch Amp Types.
LCD Contrast 0–100%	Adjusts the contrast of the main display.
Switch LED "ON" Brightness Switch LED "OFF" Brightness 1–100%	These two settings independently adjust the brightness of footswitch LEDs when they are turned ON or OFF.
Fade Selected Effect Timeout OFF, 1–10 Seconds	On the Home page, the selected effect is highlighted with a yellow box. If you find this distracting while playing, you can set the highlight to fade after a period of up to 10 seconds. To bring the highlight back, simply turn SELECT by one click, or toggle any effect on or off.

SETUP > Reset

PARAMETER	Description
Reset System Parameters	<p>This utility resets ALL parameters in the SETUP menu and Tuner back to factory default values. Resetting system parameters can be useful during troubleshooting. Importantly, this action does not delete or modify your presets. You will be prompted to press SAVE and then ENTER to confirm.</p> <p>IMPORTANT! Always turn your amp or speakers off before performing RESET SYSTEM PARAMETERS.</p>
Clear all Presets	<p>These options allow you to Clear all Presets or Erase all User Cabs. You will be prompted to press ENTER to confirm.</p>
Erase all User Cabs	<p>IMPORTANT! These operations are irreversible! Be sure you have a backup of any important data before use.</p>

SETUP > System Info

PARAMETER	Description
	<p>This screen shows the current firmware version, installed DynaCabs version, the firmware release date, and current CPU level.</p>

Specifications

INPUT

Connector:	(1) 1/4" jack, unbalanced
Impedance:	1 M Ω (less w. "Input Impedance" settings applied.)
Max. Input Level:	+20dBu

A/D CONVERSION

Bit Depth:	24 bits
Sample Rate:	48 kHz
Dynamic Range:	114 dB
Frequency Response:	20 – 20kHz, +0 / -1 dB

ANALOG OUTPUTS

Connectors:	(2) 1/4" jack balanced TRS
Impedance:	1K Ω
Max Output Level:	+16dBu

INSERT SEND

Connector:	(1) 1/4" jack, TRS (Tip = Left, Ring = Right)
Impedance:	1K Ω
Max Output Level:	+16dBu

INSERT RETURN

Connector:	(1) 1/4" jack, TRS (Tip = Left, Ring = Right)
Impedance:	1M Ω

HEADPHONE OUTPUT

Connectors:	(1) 3.5mm jack stereo, Impedance: 35 Ω . Recommended headphone impedance < 600 Ω
-------------	---

D/A CONVERSION

Dynamic Range:	114 dB
Frequency Response:	20 – 20kHz, +0 / -1 dB

DIGITAL I/O

Connectors:	RCA Coaxial Type for S/PDIF in and out
Format:	Uncompressed PCM
Sample Rate:	48 kHz fixed

USB AUDIO

Format:	USB 2.0 Class compliant, USB Type "C" connector
Channels:	4 (2 in, 2 out, each mapped to specific ports internally)
USB Audio Clock:	48 kHz fixed

MIDI INTERFACE

Input Connector:	(1) TRS 3.5 mm Female – Type A
Output Connector:	(1) TRS 3.5 mm Female – Type A
Thru:	No dedicated connector, but incoming MIDI can be merged to the output by enabling Setup > MIDI/Remote > MIDI Thru to "ENABLED"

PEDAL INTERFACE

Connectors:	(2) 1/4" TRS phone jack
Format:	Pedal: 10–100 k Ω max Switch: momentary or latching

GENERAL

Finish:	Powder coated steel chassis.
Controls:	6 buttons, 5 knobs, 4 footswitches.
Display:	480 × 272 high contrast color LCD.
Dimensions:	10.0" W. × 2.6" H. × 6.31" D. (254.0mm W. × 66.0mm H. × 160.3mm D.)
Weight:	3 lbs 7 oz (1.56 kg)
Power Requirement:	9V DC 1.5A
Power Connector:	2.1mm barrel connector, negative center
Internal Battery:	NONE

ENVIRONMENTAL

Operating Temperature:	32 to 122 °F (0 to 50 °C)
Storage Temperature:	-22 to 167 °F (-30 to 70 °C)
Humidity:	Max. 90% non-condensing

Dimensions

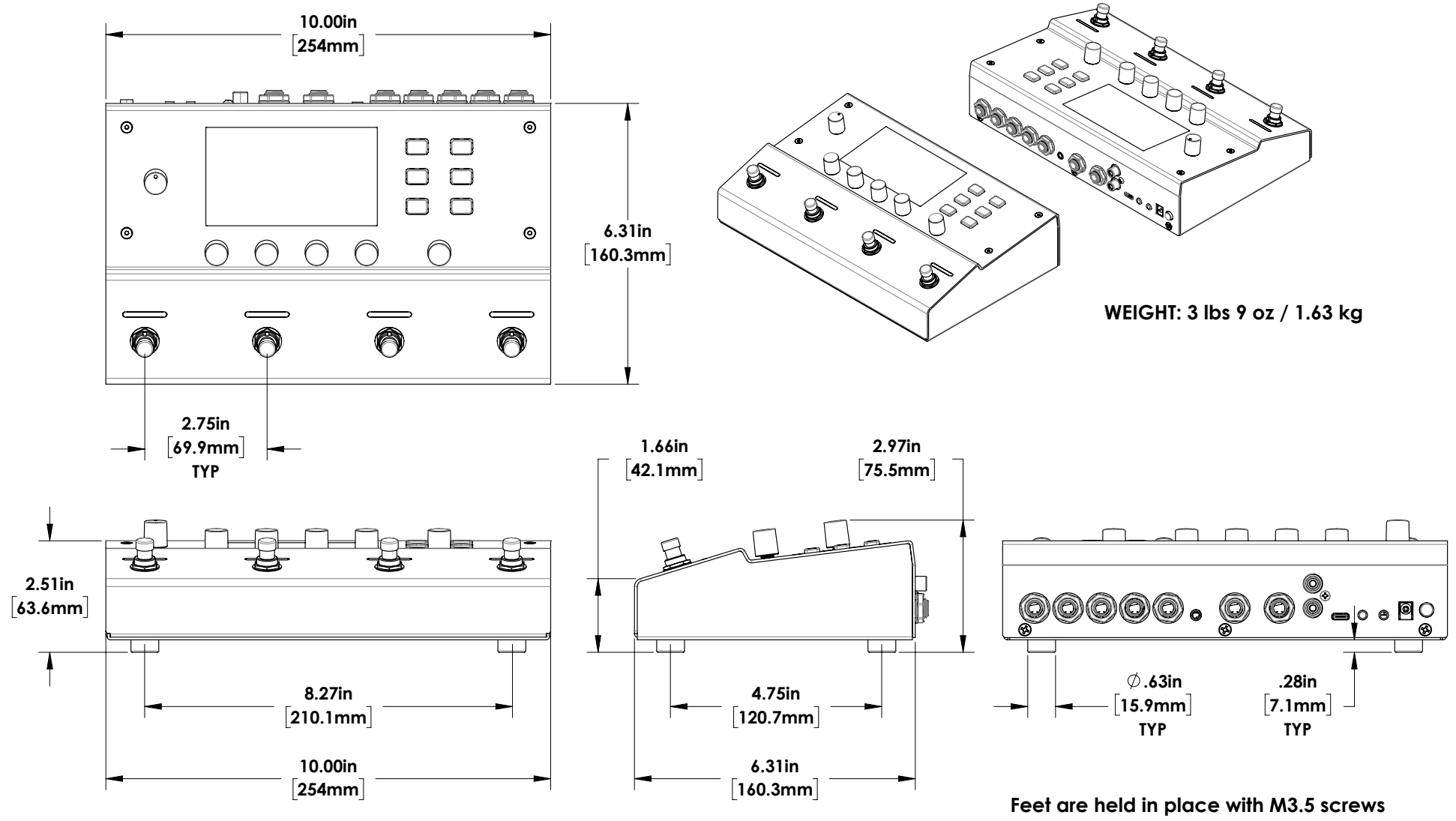

X = Not implemented 0 = Implemented

MIDI Implementation

Function		Tx	Rx	Remarks
Basic Channel	Default	1	1	
	Changed	1-16	1-16	
Note Number	True Voice	X	X	
Velocity	Note ON	X	X	
	Note OFF	X	X	
After Touch	Keys	X	X	
	Channels	X	X	
Pitch Bend		X	X	
Control Change		0	0	<p>The AM4 can transmit MIDI CC messages in two ways—using the custom Scene MIDI feature for per-preset control, or automatically each time a Scene is selected to keep other Fractal units or MIDI devices in sync.</p> <p>Incoming MIDI CCs can globally assigned to functions using the options in the SETUP > MIDI/Remote menu. These include Input Volume, Amp Volume, Output Volume, Tap Tempo, Tuner, four External Controllers (which can be used as Modifiers for any parameter per preset), additional Preset and Scene controls, and all block Bypass and Channel switches.</p>
Program Change	True Number	0	0	The AM4 can transmit PC messages in two ways—using the custom Scene MIDI feature for per-preset control, or automatically each time a Preset is selected using SETUP > MIDI/Remote > Send MIDI PC.
	Bank Select	X	X	
System Exclusive	Fractal Audio	0	0	SysEx is used extensively for AM4-Edit and certain 3rd party integrations.
	Real time	0	X	
	Non-Real time	X	X	
System Common	Song Position	X	X	
	Song Select	X	X	
	Tune Request	X	X	
System Real time	Clock	X	0	AM4 Global Tempo syncs automatically to MIDI Beat Clock. AM4 does not transmit MIDI clock.
	Commands	X	X	
Auxiliary Messages	Local ON/OFF	X	X	
	All Notes OFF	X	X	
	Active Sense	X	X	
	Reset	X	X	

MIDI PC# to AM4 Presets

PC#	Preset				
000	A1	028	H1	056	O1
001	A2	029	H2	057	O2
002	A3	030	H3	058	O3
003	A4	031	H4	059	O4
004	B1	032	I1	060	P1
005	B2	033	I2	061	P2
006	B3	034	I3	062	P3
007	B4	035	I4	063	P4
008	C1	036	J1	064	Q1
009	C2	037	J2	065	Q2
010	C3	038	J3	066	Q3
011	C4	039	J4	067	Q4
012	D1	040	K1	068	R1
013	D2	041	K2	069	R2
014	D3	042	K3	070	R3
015	D4	043	K4	071	R4
016	E1	044	L1	072	S1
017	E2	045	L2	073	S2
018	E3	046	L3	074	S3
019	E4	047	L4	075	S4
020	F1	048	M1	076	T1
021	F2	049	M2	077	T2
022	F3	050	M3	078	T3
023	F4	051	M4	079	T4
024	G1	052	N1	080	U1
025	G2	053	N2	081	U2
026	G3	054	N3	082	U3
027	G4	055	N4	083	U4
				084	V1
				085	V2
				086	V3
				087	V4
				088	W1
				089	W2
				090	W3
				091	W4
				092	X1
				093	X2
				094	X3
				095	X4
				096	Y1
				097	Y2
				098	Y3
				099	Y4
				100	Z1
				101	Z2
				102	Z3
				103	Z4

Note: This table also indicates which Program Change message is transmitted for each preset when SEND MIDI PC is turned on ([p. 51](#)).

Warranty

Fractal Audio Systems warrants that your new Fractal Audio Systems product shall be free of defects in materials and workmanship for a period of one (1) year from the original date of purchase directly from Fractal Audio Systems.

During the warranty period, Fractal Audio Systems shall, at its sole option, either repair or replace any product that proves to be defective upon inspection by Fractal Audio Systems.

Fractal Audio Systems reserves the right to update any unit returned for repair and to change or improve the design of the product at any time without notice. Fractal Audio Systems reserves the right to use reconditioned parts and assemblies as warranty replacements for authorized repairs. This warranty is extended to the original retail purchaser for units purchased directly from Fractal Audio Systems or one of its authorized distributors or resellers.

This is your sole warranty. Fractal Audio Systems does not authorize any third party, including any dealer or sales representative, to assume any liability on behalf of Fractal Audio Systems or to make any warranty for Fractal Audio Systems. Fractal Audio Systems may, at its option, require proof of original purchase date in the form of a dated copy of original authorized dealer's invoice or sales receipt. Service and repairs of Fractal Audio Systems products are to be performed only at the Fractal Audio Systems factory or a Fractal Audio Systems authorized service center. Fractal Audio Systems may require advanced authorization of repairs to authorized service centers. Unauthorized service, repair or modification will void this warranty.

DISCLAIMER AND LIMITATION OF WARRANTY

THE FOREGOING WARRANTY IS THE ONLY WARRANTY GIVEN BY FRACTAL AUDIO SYSTEMS AND IS IN LIEU OF ALL OTHER WARRANTIES. ALL IMPLIED WARRANTIES, INCLUDING WARRANTIES OF MERCHANTABILITY AND FITNESS FOR ANY PARTICULAR PURPOSE, EXCEEDING THE SPECIFIC PROVISIONS OF THIS WARRANTY ARE HEREBY DISCLAIMED AND EXCLUDED FROM THIS WARRANTY. UPON EXPIRATION OF THE APPLICABLE EXPRESS WARRANTY PERIOD (1 YEAR), FRACTAL AUDIO SYSTEMS SHALL HAVE NO FURTHER WARRANTY OBLIGATION OF ANY KIND, EXPRESS OR IMPLIED. FRACTAL AUDIO SYSTEMS SHALL IN NO EVENT BE LIABLE FOR ANY SPECIAL, INCIDENTAL OR CONSEQUENTIAL DAMAGES SUFFERED BY THE PURCHASER OR ANY THIRD PARTY, INCLUDING WITHOUT LIMITATION, DAMAGES FOR LOSS OF PROFITS OR BUSINESS, OR DAMAGES RESULTING FROM USE OR PERFORMANCE OF THE PRODUCT, WHETHER IN CONTRACT OR IN TORT. FRACTAL AUDIO SYSTEMS SHALL NOT BE LIABLE FOR ANY EXPENSES, CLAIMS, OR SUITS ARISING OUT OF OR RELATING TO ANY OF THE FOREGOING. Some states do not allow the exclusion or limitation of implied warranties so some of the above limitations and exclusions may not apply to you. This warranty gives you specific legal rights, and you may also have other rights, which vary, from state to state. This warranty only applies to products sold and used in the USA and Canada. Fractal Audio Systems shall not be liable for damages or loss resulting from the negligent or intentional acts of the shipper or its contracted affiliates. You should contact the shipper for proper claims procedures in the event of damage or loss resulting from shipment.

EULA

BY ACCEPTING, INSTALLING OR USING ANY PART OF THIS PRODUCT YOU ARE CONSENTING TO ALL OF THE TERMS AND CONDITIONS OF THIS ENTIRE END USER LICENSE AGREEMENT ("EULA"). IF YOU DO NOT AGREE TO ALL THE TERMS AND CONDITIONS OF THIS ENTIRE AGREEMENT, ARE UNABLE OR UNWILLING COMPLY WITH THESE TERMS AND CONDITIONS, YOU MUST DISCONTINUE USE OF THE PRODUCT IMMEDIATELY AS YOU HAVE NO AUTHORITY OR LICENSE TO USE THE PRODUCT.

TERMS AND CONDITIONS

1) GRANT OF LICENSE FOR PRE INSTALLED OR USER UPGRADED FIRMWARE ("THE SOFTWARE")

Subject to the terms and conditions set forth herein, Fractal Audio Systems, ("FAS") grants you an individual, personal, non-sub licensable, nonexclusive license to use this product in accordance with the applicable end user documentation, if any (the "License"). The user will not, directly or indirectly, reverse engineer, decompile, disassemble or otherwise attempt to discover the source code or underlying ideas or algorithms of the Software; modify, translate, or create derivative works based on the Software; or copy (except for archival purposes), rent, lease, distribute, assign, or otherwise transfer rights to the Software (except as expressly authorized by this Agreement); remove any proprietary notices, comments, terms and conditions and or labels on or in the Software. As between the parties, you acknowledge that FAS and its licensors retain their respective ownership of the Software, any portions or copies thereof, and all rights therein throughout the world. Upon termination of this Agreement for any reason, the License and all rights granted to you under this Agreement will terminate and you will cease to use the Software. You may permanently transfer the limited rights of use of the Software granted to you under this Agreement only as part of a permanent sale or transfer of the hardware device containing the software, and only if the recipient agrees to be bound by the terms and conditions of this Agreement. You acknowledge that you have no rights in or to, and may not transfer or otherwise authorize the use of, any "beta" or "preview" software of FAS and its licensors. THIS LIMITED LICENSE TO USE AND TRANSFER THE SOFTWARE IS PROVIDED AS-IS AND IS SUBJECT TO THE RESTRICTIONS, INDEMNITY AND WARRANTY DISCLAIMERS AND LIMITATIONS OF LIABILITY SET FORTH BELOW.

2) RESTRICTIONS, WARRANTY DISCLAIMERS AND INDEMNITY OBLIGATION AGREED TO BY YOU IN EXCHANGE FOR LIMITED GRANT OF LICENSE.

YOU WILL ONLY USE THE SOFTWARE FOR LAWFUL PURPOSES AND IN COMPLIANCE WITH ALL APPLICABLE LAWS. YOU HEREBY AGREE TO DEFEND AND INDEMNIFY FAS AND ITS LICENSORS AGAINST ANY CLAIM OR ACTION THAT ARISES FROM YOUR USE OF THE SOFTWARE IN AN UNLAWFUL MANNER (INCLUDING, WITHOUT LIMITATION, ANY CLAIM OR ACTION ALLEGING INFRINGEMENT OF ANY PATENT, COPYRIGHT, TRADEMARK, TRADE SECRET, OR OTHER INTELLECTUAL PROPERTY; UNFAIR COMPETITION; VIOLATION OF GENERAL BUSINESS LAWS; OR VIOLATION OF ANY OTHER LAWS OR RIGHTS) OR ANY OTHER USE OF THE SOFTWARE NOT EXPRESSLY AUTHORIZED PURSUANT TO THIS AGREEMENT.

3) IMPULSE RESPONSE EXPORT FOR COMMERCIAL USE

Offering for sale any Impulse Response data (e.g. "Tone Match Export/Save/Dump", "User Cab Export/Save/Dump") created, converted or modified using Fractal Audio Systems hardware and/or software requires a commercial use license. Recording studios, consultants, and other commercial entities may use these features in conjunction with work performed for their commercial customers, but the resulting data files created may not be offered for sale or gifted to their commercial customers or other third parties without a commercial license from FAS and its licensors where applicable. Contact sales@fractalaudio.com to obtain a commercial license.

4) IMPULSE RESPONSE DATA EXPORT FOR NON-COMMERCIAL USE

If the product supports Impulse Response capture and export, you are free to export Impulse Response data for non-commercial use. This includes producing, converting, or modifying Impulse Response data for yourself, or offering/distributing such data at no charge to third parties. Creating Impulses for sale requires a Commercial License. Files created without a commercial license cannot be included for free with another product or package that is offered for sale. Contact sales@fractalaudio.com to obtain a commercial license.

5) SUPPORT

Subject to the terms hereof, FAS will provide you with e-mail support services for the Software. Under no circumstances will FAS have any obligation to provide you with hard-copy documentation, upgrades, enhancements, modifications, or telephone support for the Software.

6) TERMINATION

This Agreement is effective until terminated. Either party may terminate this Agreement upon written notice to the other party. FAS may also terminate this Agreement immediately, without prior notice or liability, if you breach any of the terms or conditions of this Agreement. All sections of this Agreement which by their nature should survive termination will survive termination, including, without limitation, warranty disclaimers and limitations of liability and limitations of use and transfer of the Software.

7) WARRANTY DISCLAIMER

The software is provided as is without warranty of any kind. FAS disclaim all warranties, expressed or implied, including but not limited to implied warranties, fitness for a particular purpose, and non-infringement. Some states do not allow limitations on how long an implied warranty lasts, so the above limitation may not apply to you.

8) LIMITATION OF LIABILITY

NOTWITHSTANDING ANYTHING CONTAINED IN THIS AGREEMENT OR OTHERWISE, YOU AGREE THAT FAS AND ITS LICENSORS WILL NOT BE LIABLE WITH RESPECT TO THE SUBJECT MATTER OF THIS AGREEMENT UNDER ANY CONTRACT, NEGLIGENCE, STRICT LIABILITY, INFRINGEMENT OR OTHER LEGAL OR EQUITABLE THEORY FOR ANY INCIDENTAL, CONSEQUENTIAL, EXEMPLARY OR PUNITIVE DAMAGES OF ANY KIND. SOME STATES DO NOT ALLOW THE EXCLUSION OR LIMITATION OF INCIDENTAL OR CONSEQUENTIAL DAMAGES, SO THE ABOVE MAY NOT APPLY TO YOU.

9) EXPORT RESTRICTIONS

You acknowledge that the Software, or any part thereof, or any process or service that is the direct product of the Software (the foregoing collectively referred to as the "Restricted Components") are of U.S. origin. You agree to comply with all applicable international and national laws that apply to these products, including the U.S. Export Administration Regulations, as well as end-user, end-use and destination restrictions issued by U.S. and other governments.

10) MISCELLANEOUS

The failure of either party to exercise in any respect any right provided for herein will not be deemed a waiver of any further rights hereunder of FAS and or its licensors. If any provision of this Agreement is found to be unenforceable or invalid, that provision will be limited or eliminated to the minimum extent necessary so that this Agreement will otherwise remain in full force and effect and enforceable. This Agreement will be governed by and construed in accordance with the laws of the state of New Hampshire without regard to the conflict of laws provisions thereof. You agree that this Agreement is the complete and exclusive statement of the mutual understanding of the parties and supersedes and cancels all previous written and oral agreements, communications and other understandings relating to the subject matter of this Agreement, and that all modifications to this EULA, or any commercial license that you may have obtained from FAS and or its licensors must be in a writing signed by you, FAS and or its licensors, where applicable, except as otherwise provided herein. No agency, partnership, joint venture, or employment is created as a result of this Agreement and you do not have any authority of any kind to bind FAS and or its licensors in any respect whatsoever. In any action or proceeding to enforce rights under this Agreement, the prevailing party will be entitled to recover costs and attorneys' fees. All notices under this Agreement will be in writing and will be deemed to have been duly given when received, if personally delivered; when receipt is electronically confirmed, if transmitted by facsimile or e-mail; the day after it is sent, if sent for next day delivery by recognized overnight delivery service; and upon receipt, if sent by certified or registered mail, return receipt requested.

FACTORY PRESETS

The AM4 includes a set of pre-installed Factory Presets. All preset locations are user-writable and may be modified or replaced at any time. Several locations are intentionally left empty so you can store your own creations immediately.

Presets and amp models are distinct. The AM4 includes more amp models than preset slots; however, the Factory Preset set covers all essential models.

Updated Factory Presets and a PDF installation guide are available from our website.

AM4-Edit provides a **Manage Presets** tool that supports drag-and-drop reordering as well as copy, paste, import, export, clear, and more.

Factory Preset Notes

A1	AM4 Gig Rig	Four classic amps, each with its own unique channel settings for amp/cab, drive, delay, and reverb.
A2	59 Bassguy	Born for bass but beloved by guitarists, the 59 Bassguy delivers legendary warm cleans and sweet overdrive.
A3	65 Bassguy	A mid-'60s favorite of Clapton and Fogerty, the 65 Bassguy delivers tight cleans and smooth breakup.
A4	5153	Three 100W channels from the 5153 stack plus a bonus 50W blue on Scene 4. Based on a Brett Kingman preset.
B1	5153 Stealths	The Stealth version features darker voicing, a tighter low end, more gain. Based on a Brett Kingman preset.
B2	6160s	Raw and aggressive with looser lows and gritty saturation, the 6160 delivers classic high-gain attitude.
B3	A-Class 30	An iconic Class A 2x12 with chimey cleans, jangly mids, and rich overdrive that shaped the sound of countless rock and pop legends.
B4	AC-20	Fantastic 1x12 boutique amp with sweet chime, touch sensitivity, and smooth breakup. Includes switches for preamp tube and treble/bass modes.
C1	Archaen	Modern and versatile with tight low end, rich mids, and saturated high-gain tones—plus a classic full-bodied clean channel. Brett Kingman.
C2	Atomica + CCV	Two hot-rodged British-style amps with both vintage crunch and high-gain tones.
C3	Bass Brigade	USA Bass paired with an aluminum speaker, plus a 1x15 Porta Bass, and a bonus envelope follower scene.
C4	Bass NoAmp Pre	A legendary bass DI tone box promising tube sound. Also try the Blackglass 7k and Pi Fuzz bass scenes.
D1	Band Commander	Classic '60s amp known for big cleans and grindy, edgy drive—perfect for surf, blues, and vintage rock tones. Based on a Brett Kingman preset.
D2	Black Magick	The Supro Black Magick combo inspired by Jimmy Page. Preset by Austin Buddy.
D3	Bludojai Buddy	A boutique-style “D” type amp prized for responsive feel and violin-like overdrive. By Austin Buddy.
D4	Bogfish	A rare multi-channel rack preamp popular for heavy rock and early '90s metal players. Brett Kingman.
E1	Bonus Brits	Four British amps in one preset— Brit Silver, Plexi Studio 20, Plexi 2204, Brit Super—Classic and hot-rodged tones.
E2	Brit 800s	Iconic crunch and searing lead tones from three of the seven onboard 800 models, including the Studio 20. Based on a Brett Kingman preset.
E3	Brit JVM	A menu of tones—OD1 Green, OD1 Orange, OD2 Red, plus a bonus Red with FX. Based on a Brett Kingman preset.
E4	Brown Sounds	Combines “Brown Sound” presets from Axe-Fx III and Brett Kingman. Use an expression pedal on scene 4.
F1	Buddah DuoMaster	Dialed from clean to hot drive—plus comp and drive pedals for even more expressive tones. Based on a Brett Kingman preset.
F2	CA3+	L.A. session legend, delivering polished cleans, tight crunch, and ripping lead tones. Based on a Brett Kingman preset.
F3	Captain Hook	A snarling British-American fusion that can be gritty, punchy or cranked for bluesy hard rock.
F4	Carol Anns	Three boutique Carol Ann amps across four scenes—Triptik, Tucana Lead, plus OD-2.

G1	Citrus City	Something rhymes with orange! Clean and Dirty A30, plus Tiny Terrier, and RV50.
G2	Cleanup Crew	A JC-style clean, a crystal clean direct-to-console, plus two chimey clean amps.
G3	Deluxe Tweed	Perhaps the most classic combo of all time—warm cleans, touch-responsive breakup, and unmistakable bite.
G4	Deluxe Verb	All-time 1x12 classic American clean with clear highs, classic spring reverb, optical tremolo, and smooth edge-of-breakup drive.
H1	Destructive Appetites	AFS-100... and 800#34 Hot-rodged Brit beasts with enough bite to slash their way through the jungle.
H2	Divided By	13—uh, TWO boutique CJ/FT-style amps, plus a phaser scene for some vintage swirl.
H3	Dizzy Herbie	Massive multi-channel high-gain amp with Mids, Scooped, and Lead tones—plus a Mk III scene.
H4	Dizzy V4 Silver	Four tones from three gain channels of a four-channel high-gain heavy hitter.
I1	Double Tweed 5F8	High-Power Tweed with a big, open sound great for edge-of-breakup playing.
I2	Double Verb	The definitive clean 2x12—classic mid-'60s voicings plus a later '70s silverface version, all loud, proud, and pedal-ready.
I3	Fox ODS	A boutique special overdrive perfect for fusion, blues, and expressive rock.
I4	Friedman BE/HBE	Dave Friedman's ultimate hot-rodged rock machine—two BE crunch voices and two HBE high-gain voices.
J1	Hi-Gain Heavies	Four modern high-gain heavies: An Uber-style, two Angles, and a hot-rodged Nitrous brute.
J2	Hipower	A staple of '70s stadium rock—normal, brilliant, and jumped versions deliver unmistakably bold tones.
J3	Hot Kitty	A punchy (and heavy!) amp with firm lows, crisp attack, and plenty of drive.
J4	JM45	The original British blues-rock amp—warm cleans and rich crunch that defined an era. Amazing amp for pedals.
K1	JMPre-1	Four scenes from the classic rack preamp—OD1, OD2, OD2 with FX, plus a cool clean. Def check it out.
K2	JR Blues	Four flavors from the little combo that could—Clean, Gainy, Fat, and Cranked plus onboard spring reverb and 4 drive pedals to try.
K3	JS410	Four voices from a modern four-channel shred head—Crunch Orange, Crunch Red, Lead Orange, and Lead FX.
K4	Legend 100	100-watt amp known for signature tones, paired with updated FX from the Steve Vai “Gift of Tone” presets.
L1	Matchboxes	Boutique Chiefman and D30 tones, including the EF86 variant for added flavor.
L2	Modern Monsters	Four monsters in one—“Djentlymanly” with amp settings by Mr. Mansoor himself, joined by Brootalz, Skull Crusher, and Modern III.
L3	Mr. Z Collection	Three dynamic, pedal-friendly amps built for real-world players, from big clean to low-watt grind.
L4	Nuclear Tone	Dripping with retro vibe—killer trem, dripping springs, sweet breakup, and plenty of “small amp cranked too hard” mojo.
M1	ODS-100	The amp, the legend. You don't play it—it plays you. Notes bloom, sustain flows, and whapooshes ensue. The (very) high-end special overdrive.
M2	Petrucci Rig AM4	Four scenes of tonal majesty inspired by JP. The J stands for “John”. We can't decide if the P is for Prog, Power, or Perfection because all apply!
M3	Plexi 50W	Bold, raw, and loud, this 50-watt British beast defined the bite and punch of rock guitar, and these are just four of the seven 50W Plexis onboard!
M4	Plexi 100W	Bigger, bolder, and louder—the 100-watt powerhouse that ruled defiantly like an unstoppable English overlord. Preset by Austin Buddy.
N1	Princetones + 5F1	Three eras of Princetone combos—Tweed, Blackface, and Reverb—plus a Tweed “Champlifier” 5F1—the slowhand signature style.
N2	Recto 1	Four scenes from the original amp that defined the Nu sound of '90s and '00s high-gain guitar tone.
N3	Recto 2	The 3-channel version of the Recto with Red and Orange Vintage and Modern. The Recto presets are based on originals by Leon Todd and others.
N4	Revv Gen	Green, Purple, and Red channels from the modern Canadian high-gain heavyweight of hi gain.

O1	RockM@ Clean	A nod to the classic headphone amp “Clean 2”—super bright, super compressed, and super 80s.
O2	Shirley Smallbox	Two Hot Rod Friedman amps—Dirty Shirley and Small Box—each with Crunch and Lead tones.
O3	Solo 100 AB	Solo 100 scenes for a gig ready rig preset by Ausin Budddy.
O4	Q-Rod Rig MF	Spawn Quickrod scenes in a gig-ready rig preset by Marco Fanton.
P1	Suhr Badgers	Two Badger amps—18 and 30 watts—each with Cool and Hot scenes for chime and crunch.
P2	Supers + Concert	Two channels from the mid-’60s 4×10 combo, plus earlier “blonde-era” Super and Concert circuits—three classic Fullerton amps.
P3	SV Bass	From huge clean lows to gritty growl—everything that makes this colossus a fixture in the bass world.
P4	Texas Star	A mid-driven American-style amp with a slightly ragged edge—clean to crunch and beyond with pedals, plus a lead channel.
Q1	Triple Crest	Clean, Crunch, and Lead from a three-channel modern amp with sound as big as the lone star state.
Q2	Try Axes Pre	Four scenes from a classic rack preamp—Clean FX, LD2 Green, Yellow, and Red for progressively hotter tones.
Q3	USA Mk IV	Four scenes from the 4th evolution of the Petaluma hot-rod—Rhythm 1 Clean, Rhythm 2 Fat, Lead Fat, and Lead Mid.
Q4	USA Mk V	A history of the Mark series in one box, as they say.. Here you have Red XT, MKIV, and IIC+ modes, plus a classic clean.
R1	Vibrato Lux + King	A classic mid-’60s 1×12 combo with tremolo, paired with a 90s Custom Shop model in Normal and Fat modes.
R2	Vibrato Verb SRV	Classic SRV-style 1×15 combo tones plus a great sounding 4×12 EV on Scene 4.
R3	W-Rocket +Liverpool	Two hand-built NJ “Wreckers” by Ken Fischer—Rocket for chime and smooth breakup, Liverpool for tighter mids and a rawer edge.
R4	Wrecker Express	Ken Fischer’s higher-gain design—more muscular and immediate, yet still touch-responsive and harmonically rich.
S1	Brett’s Gig Rig EV12	Four different amps into our x-pattern “Rumble” cab for a gig rig preset by Brett Kingman.
S2	Brett’s Gig Rig V30	Variation on the above into a V30 4×12. Gig rig preset by Brett Kingman.
S3	EJ Clean CC	One of the greatest clean tones of the 20th century, dialed in by Cooper Carter.
S4	EJ Lead ACL CC	...And the corresponding EJ lead in two versions by Cooper Carter.
T1	Jimi Stratosphere! AB	Austin Buddy pairs the JM45 with essential late ’60s effects—capturing the unmistakable atmosphere and expressive depth of an iconic sound.
T2	Deva Sky M@	Highlights some of the AM4’s incredible effects—a sampler to inspire the creativity that thrives on what’s there instead of dwelling on what’s not.
T3	Bad Wolf Rising LM	A great set of performance tones from grammy award-winning producer and solo artist Larry Mitchell..
T4	My 80’s LM	Four 80s-esque scenes from Larry Mitchell.
U1	Leon’s Live AM4	A gig-rig preset with 4 dialed in channels in every block. Preset by Leon Todd.
U2	Leon’s Djenty 5153	Djent. Djent. Djent djent djent. Preset by Leon Todd
U3	Pitch Follow Magic LT	The pitch follower is used to adjust effect mix and more as you play higher or lower. Preset by Leon Todd
U4	Tape Loops LT	What if an analog delay and a digital LFO had a love child? Leon Todd struts his creative stuff.
V1	More Gary FSM	Thick sustain, searing vibrato, and soaring leads—turn it up and still get the blues. Preset by Frank Steffen Mueller.
V2	Yngwie! FSM	Unleash the freakin fury with this preset by Frank Steffen Mueller.
V3	Call from Mr. Floyd	Four road-tested tones in a preset by Cooper Carter and Edo Scordó.
V4	MF Euro	Euro XTC gig rig preset by Marco Fanton.

A version of this article was originally published in the manual for the VP4 Virtual Pedalboard. It is included here as an appendix since the AM4 can be used with the VP4 as well as other effect pedals and processors.

Pre vs. Post Effects

A guitar amp has two main sections: the preamp and the power amp. The preamp shapes the initial tone, adding gain and often distortion to your signal. The power amp then amplifies this shaped signal to drive your speakers, making it louder. Some power amps also produce desirable distortion or other tonal characteristics that further color your sound.

The placement of effects before or after distortion has a major impact on the overall tone, and the same principle applies to the order of distortion pedals and other effects. While there are common practices, experimenting with placement can lead to unique results. Understanding why certain effects are typically placed PRE or POST—and how this shapes your tone—will help you to achieve the sounds you're after.

PRE Effects (Before Distortion/Preamp)

Effects such as overdrive, distortion, wah, and compression are traditionally placed before the preamp. This lets them act directly on the guitar's raw signal, shaping tone, dynamics, and the amount of drive hitting the front end. Try a simple experiment with a Wah, a Drive, and a clean amp. When you place the wah in front of distortion, it results in a traditional tone, where the wah excites certain frequencies as you sweep it (btw who doesn't love a parked wah tone?!). Move the wah after distortion, and it instead boosts or cuts the harmonics the drive creates for a more synthetic effect. (Many synthesizers use filters this way, placing them after harmonically rich oscillators.) You can try this same experiment with EQ, phaser, and other effects as well.

TIP: AM4-Edit allows you to drag and drop effects to swap them!

POST Effects (After Distortion/Preamp)

"Time-based" effects such as reverb, delay, and even chorus are often placed *after* the preamp. This allows the repeats, ambience, or subtle modulation to be heard clearly and distinctly—instead of being "trashed" by any front end distortion. If you just tried the experiment above, you know that effects such as filters and EQ can be used to dramatically shape the sound of distortion. At the same time, a rotary effect will sound *familiar* after distortion, since it simulates a moving physical speaker that's last in line.

Exceptions and Special Cases

The first exception is a big one. *Creativity does not play by the rules.* In fact, any effect can in fact be placed in any position. For example, echo or delay into a cranked amp or drive pedal was part of "the sound of the 70s" and is still widely used today in many styles of music. Artists like The Edge, Neil Young, Eric Johnson, and Jimmy Page have all utilized this technique, creating some of the most iconic tones in history. Even distortion itself can be an outlier. In metal, industrial, punk, and other styles, distortion can be used in unconventional ways to achieve aggressive saturation and lofi effects.

EQs and effects that sculpt tone – including phasers, flangers, filters, and more—create different but useful and interesting sounds either before or after distortion. Try it and listen for yourself by placing these effect blocks before or after a distorted Amp block.

Pitch effects, available on products like our VP4 or from external pedals, are a special case. Consonant harmonies such as 5ths and octaves can sound huge when run into distortion. Shifters with no Mix control—like a Whammy or Virtual Capo—often sound more natural before the preamp but can take on "chipmunk" or "ogre-like" qualities when placed after. Complex or dissonant harmonies, as well as subtle detune or shimmer effects, tend to get buried by distortion, so they're usually placed post. Since shimmer and similar effects also create new high or low frequencies, their response changes depending on their position relative to distortion, EQ, or filters. Ring modulators behave the same way. As always—experiment and trust your ears.

Summary

PRE EFFECTS shape the fundamental tone and dynamics of the guitar signal before it's amplified or distorted. They can also be used to push your preamp, changing its tone, distortion, and dynamics.

POST EFFECTS can add ambience, depth, and modulation to the already shaped or distorted signal without compromising clarity. They can also have a more profound effect on distortion by changing its tone in dramatic and noticeable ways.

ALL EFFECTS can be placed where you think they sound best. You can learn more about the creative use of effects by studying the rigs of your guitar heroes, by experimenting with the AM4 and your other equipment, and by learning more about audio, acoustics, physics, sound design, and music.

AM4 for Fractal Veterans

THE NEW AMP BLOCK

- The Amp block and Cab block are combined into a **single Amp block** on the AM4. Like other AM4 blocks, the amp features simplified front-panel controls.
- The amp's **Expert Edit** menu includes many of the settings and options found on our other products, including preamp boost, power supply sag, variac, and more.
- Within the consolidated Amp block, you can fully enable or disable the **Amp Section** and **Cab Section** independently—as if they were separate blocks.
- The number of amps is different because some “legacy” amp types have been removed and others have been consolidated. For example, the two models **JR BLUES** and **JR BLUES FAT** are now one model with an actual **Fat** switch.
- Each preset stores a custom **LED color** for each of the four amp channels without the need for anything like “per preset” switches.
- Due to the compact four-block “grid”, the Amp block includes two functions that would normally require separate blocks:
 - **Amp Out Boost:** A built-in, footswitchable boost of up to +4 dB. See [p. 25](#).
 - **Amp Out Volume:** The **Setup > MIDI/Remote > Amp Block Out Volume** control provides an alternative to inserting a Volume block between the amp and post effects. It adjusts the output level of the Amp block without changing the amp's tone or drive and preserving effect tails.

CAB MODELING

- The AM4 includes a full collection of **DynaCabs** plus space for 256 User Cabs (Standard or UltraRes™).
- There are no “Legacy” cabs included, though many of these are available in Fractal Audio Cab Packs.

CPU

- The **CPU limit** on the AM4 is 85% (vs. about 80% on other units) and varies dynamically during playback. As a rule of thumb, aim for about 80% when you're not playing and then play test your preset to ensure stable performance.

EXPERT EDIT

- Like the VP4, the AM4 includes a hidden **Expert Edit** feature that reveals additional parameters like those normally visible by default on larger Fractal Audio products. Press **PAGE LEFT** and **PAGE RIGHT** simultaneously while editing any block to enter Expert Edit mode for any **block**, for the **Input Gate**, or for the **Modifier** screen.
- **Input Impedance** is found under Expert Edit for the Input Gate.

EFFECTS & MODIFIERS

- The AM4 includes a **curated selection of effects** chosen to suit its main purpose. Rather than compromising quality to support additional blocks, we chose to deliver Axe-Fx level amp and cab modeling, with effects that round out your presets and more than enough choices for a complete “gig rig”. If you reach the CPU ceiling, refocus your preset design. If you miss certain blocks, the AM4 pairs very well with the VP4 or external pedals.
- Optional automatic MIDI Program Change and “Scene Sync” messages allow **AM4** and a **VP4** to operate almost like one unit.
- VP4 and AM4 **Block Library** files are cross-compatible between editors, as long as both units are running compatible firmware versions. Amp, Cab and effect settings from Axe-Fx III, FM9, and FM3 can be matched by hand to reproduce familiar tones, but presets/blocks cannot be shared.
- For remote bypass and channel selection via MIDI, the AM4 uses the VP4's simplified system of control by position: FX1, FX2, FX3, FX4.
- The modifier system does not have a Channel setting. A modifier works across all channels.
- Note that preset “extras” (**Input Gate, Main Levels/EQ, and Controllers**) do not have channels.

OUTPUT & SIGNAL FLOW

- Under **SETUP > Output Mode**, you'll find the familiar STEREO and mono options. A new global SPLIT option runs OUT L **with** cab processing and OUT R **without**, enabling simultaneous use of direct FRFR and traditional power amp + speaker cab setups (see [p. 20](#)).
- The **LEVEL** knob on the AM4 top panel controls both analog and SPDIF output levels.

Levels Overview

The AM4 gives you control over levels at multiple points—at the input, within presets, at the analog outputs, and more. Your speakers, mixer, or interface ultimately determine listening volume, but managing levels inside the AM4 helps prevent clipping and ensures optimal performance.

The overview below goes a bit deeper than other quick start topics, but provides a good overview plus links to other topics.



Your guitar's volume control—and any pedals placed before the AM4—work just as they would with a traditional amp.



Prevents hot signals from clipping the AM4's analog-to-digital converter. It can self-adjust, but manual setting is recommended. [p.12](#)



Each preset's Input Gate has its own Level control, which can be used to boost your guitar signal before it hits any effects or amp modeling. [p.31](#)

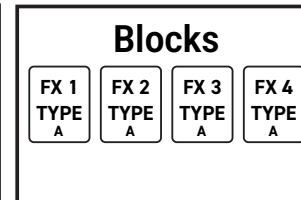

Every block affects levels. Beyond the obvious Level and Gain controls, many others change volume. Use your ears—and the meters. [p.23](#)

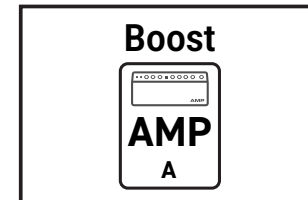

The amp includes a footswitchable boost. Set its level per channel—and view the internal levels meter—in the Amp's edit menu. [p.25](#)

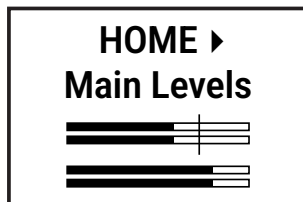

Lets you fine-tune master levels for the current preset and its scenes, with invaluable meters for both internal and analog levels. [p.31](#)

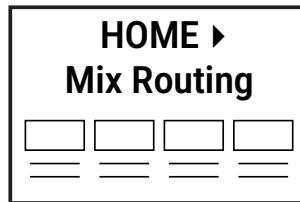

Gives quick access to all four block levels—no menu diving—and includes mini meters for easy gain staging or troubleshooting. [p.32](#)

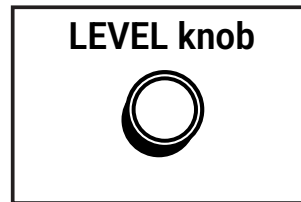

The top-panel LEVEL knob controls the volume of the main outputs and headphones, serving as the AM4's master volume. [p. 8](#)

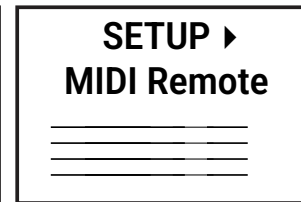

Assign MIDI CCs or pedals to control volume at the input, output, or for the amp (which preserves gain and allowing tails to ring.) [p.51](#)

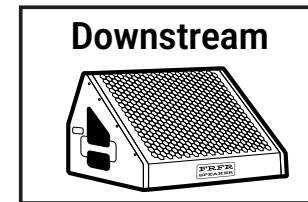

Your speakers, mixer, or interface also have their own level controls. Experiment to find what sounds and works best for your setup.



The relationship between volume and tone is an interesting subject. Musicians face an almost universal challenge of getting levels “right.”

Our support knowledgebase covers this topic in more detail at <https://support.fractalaudio.com/en-US/tips-for-setting-preset-and-scene-levels-356522>

Audio and USB Signal Flow

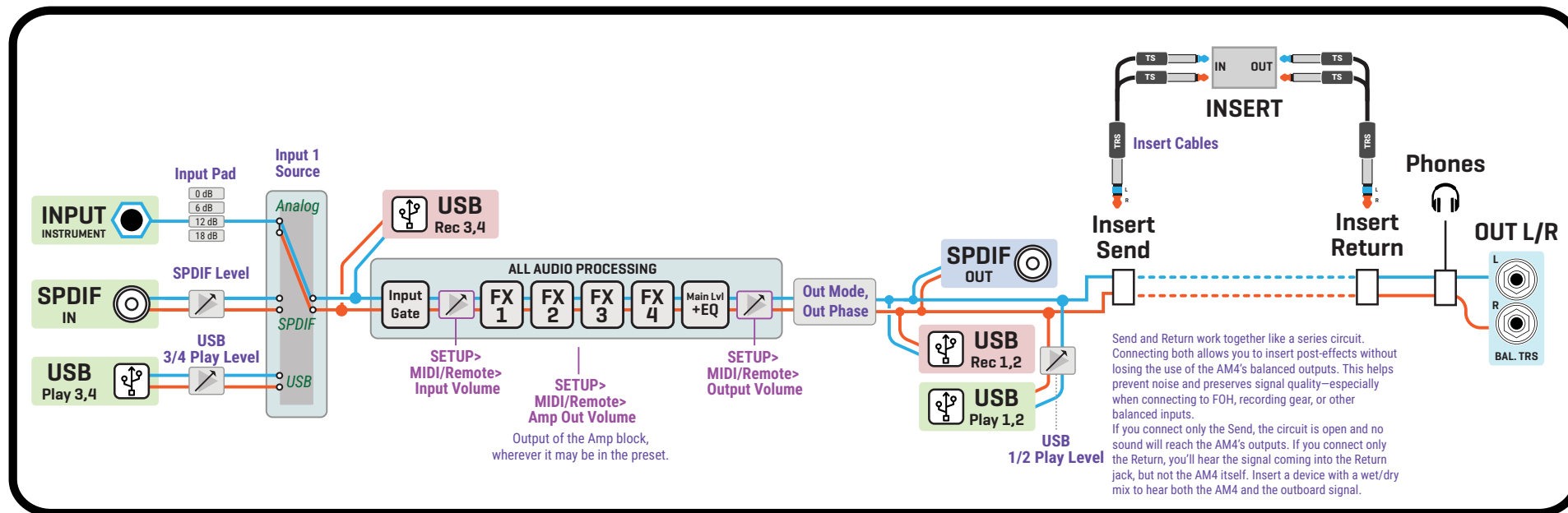

USB COMPUTER INPUTS (RECORDING)

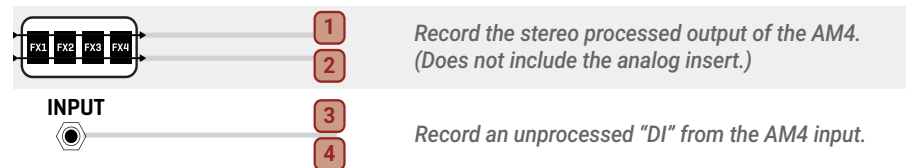

USB COMPUTER OUTPUTS (PLAYBACK)



Dimensions

