

# DIVIDED PICKUP GK-3B

## Owner's Manual

Thank you for purchasing the Roland GK-3B divided pickup. Before using this unit, carefully read the sections entitled:

- USING THE UNIT SAFELY (page 2-3)
- IMPORTANT NOTES (page 3)

These sections provide important information concerning the proper operation of the unit.

Additionally, in order to feel assured that you have gained a good grasp of every feature provided by your new unit, Owner's manual should be read in its entirety. The manual should be saved and kept on hand as a convenient reference.

---

**Copyright © 2004 Roland CORPORATION**

**All rights reserved. No part of this publication may be reproduced in any form without the written permission of Roland CORPORATION.**

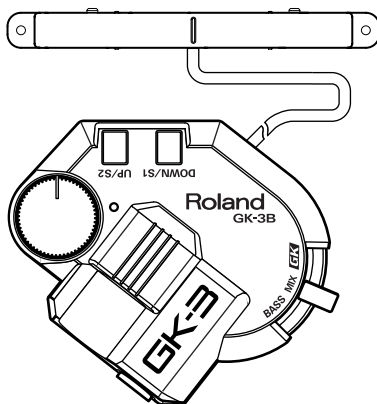

# USING THE UNIT SAFELY

## INSTRUCTIONS FOR THE PREVENTION OF FIRE, ELECTRIC SHOCK, OR INJURY TO PERSONS

About ⚠ WARNING and ⚠ CAUTION Notices

<b>⚠ WARNING</b>	Used for instructions intended to alert the user to the risk of death or severe injury should the unit be used improperly.
<b>⚠ CAUTION</b>	Used for instructions intended to alert the user to the risk of injury or material damage should the unit be used improperly. * Material damage refers to damage or other adverse effects caused with respect to the home and all its furnishings, as well to domestic animals or pets.

About the Symbols

	The ⚠ symbol alerts the user to important instructions or warnings. The specific meaning of the symbol is determined by the design contained within the triangle. In the case of the symbol at left, it is used for general cautions, warnings, or alerts to danger.
	The ⚡ symbol alerts the user to items that must never be carried out (are forbidden). The specific thing that must not be done is indicated by the design contained within the circle. In the case of the symbol at left, it means that the unit must never be disassembled.
	The ⚡ symbol alerts the user to things that must be carried out. The specific thing that must be done is indicated by the design contained within the circle. In the case of the symbol at left, it means that the power-cord plug must be unplugged from the outlet.

### ALWAYS OBSERVE THE FOLLOWING

#### **WARNING**

- Before using this unit, make sure to read the instructions below, and the Owner's Manual.
- Do not open or perform any internal modifications on the unit.
- Do not attempt to repair the unit, or replace parts within it (except when this manual provides specific instructions directing you to do so). Refer all servicing to your retailer, the nearest Roland Service Center, or an authorized Roland distributor, as listed on the "Information" page.
- Never use or store the unit in places that are:
  - Subject to temperature extremes (e.g., direct sunlight in an enclosed vehicle, near a heating duct, on top of heat-generating equipment); or are
  - Damp (e.g., baths, washrooms, on wet floors); or are
  - Humid; or are
  - Exposed to rain; or are
  - Dusty; or are
  - Subject to high levels of vibration.
- Make sure you always have the unit placed so it is level and sure to remain stable. Never place it on stands that could wobble, or on inclined surfaces.

#### **WARNING**

- Do not allow any objects (e.g., flammable material, coins, pins); or liquids of any kind (water, soft drinks, etc.) to penetrate the unit.
- Immediately turn the power off, and request servicing by your retailer, the nearest Roland Service Center, or an authorized Roland distributor, as listed on the "Information" page when:
  - If smoke or unusual odor occurs
  - Objects have fallen into, or liquid has been spilled onto the unit; or
  - The unit has been exposed to rain (or otherwise has become wet); or
  - The unit does not appear to operate normally or exhibits a marked change in performance.
- In households with small children, an adult should provide supervision until the child is capable of following all the rules essential for the safe operation of the unit.
- Protect the unit from strong impact. (Do not drop it!)



## CAUTION

- Try to prevent cords and cables from becoming entangled. Also, all cords and cables should be placed so they are out of the reach of children.



- Never climb on top of, nor place heavy objects on the unit.



- Disconnect all cords coming from external devices before moving the unit.



- Should you remove the parts of installation (screws, washers and springs), make sure to put them in a safe place out of children's reach, so there is no chance of them being swallowed accidentally.



## IMPORTANT NOTES

In addition to the items listed under "USING THE UNIT SAFELY," please read and observe the following:

### Power Supply

- Before connecting this unit to other devices, turn off the power to all units. This will help prevent malfunctions and/or damage to speakers or other devices.

### Placement

- Using the unit near power amplifiers (or other equipment containing large power transformers) may induce hum. To alleviate the problem, change the orientation of this unit; or move it farther away from the source of interference.
- Noise may be produced if wireless communications devices, such as cell phones, are operated in the vicinity of this unit. Such noise could occur when receiving or initiating a call, or while conversing. Should you experience such problems, you should relocate such wireless devices so they are at a greater distance from this unit, or switch them off.
- Do not expose the unit to direct sunlight, place it near devices that radiate heat, leave it inside an enclosed vehicle, or otherwise subject it to temperature extremes. Excessive heat can deform or discolor the unit.

- When moved from one location to another where the temperature and/or humidity is very different, water droplets (condensation) may form inside the unit. Damage or malfunction may result if you attempt to use the unit in this condition. Therefore, before using the unit, you must allow it to stand for several hours, until the condensation has completely evaporated.

### Maintenance

- For everyday cleaning wipe the unit with a soft, dry cloth or one that has been slightly dampened with water. To remove stubborn dirt, use a cloth impregnated with a mild, non-abrasive detergent. Afterwards, be sure to wipe the unit thoroughly with a soft, dry cloth.
- Never use benzene, thinners, alcohol or solvents of any kind, to avoid the possibility of discoloration and/or deformation.

### Additional Precautions

- Use a reasonable amount of care when using the unit's buttons, sliders, or other controls; and when using its jacks and connectors. Rough handling can lead to malfunctions.
- When connecting / disconnecting all cables, grasp the connector itself—never pull on the cable. This way you will avoid causing shorts, or damage to the cable's internal elements.
- To avoid disturbing your neighbors, try to keep the unit's volume at reasonable levels. You may prefer to use headphones, so you do not need to be concerned about those around you (especially when it is late at night).
- When you need to transport the unit, package it in the box (including padding) that it came in, if possible. Otherwise, you will need to use equivalent packaging materials.
- Use a cable from Roland to make the connection. If using some other make of connection cable, please note the following precautions.
  - Some connection cables contain resistors. Do not use cables that incorporate resistors for connecting to this unit. The use of such cables can cause the sound level to be extremely low, or impossible to hear. For information on cable specifications, contact the manufacturer of the cable.

<b>USING THE UNIT SAFELY .....</b>	<b>2</b>
<b>IMPORTANT NOTES .....</b>	<b>3</b>
<b>Panel Descriptions .....</b>	<b>5</b>
<b>Attaching the GK-3B to the Bass .....</b>	<b>6</b>
<b>Precautions Before Installing ....</b>	<b>6</b>
<b>Adjusting the Divided Pickup ....</b>	<b>8</b>
<b>Attaching the Divided Pickup ....</b>	<b>9</b>
Attaching the Pickup with Double- Sided Tape .....	9
Attaching the Pickup with Screws ..	12
<b>Attaching the Controller .....</b>	<b>13</b>
Adjusting the Length of the Pickup Cable .....	13
Attaching the Controller with the Holder .....	14
Attaching with Double-sided Tape and a Screw .....	18
<b>How to Connect the GK-3B .....</b>	<b>19</b>
<b>Specifications .....</b>	<b>21</b>

The GK-3B is a special divided pickup, which, when installed on an ordinary bass, allows you to use the bass to play the sounds of GK-compatible bass devices (Roland GR-20 or V-BASS etc.).

- With the pickup section featuring six individual pickup coils, this unit is compatible even with six-string basses.
- Spacings between the pickup coils are adjustable in a range from 16 mm (0.68") to 19 mm (0.75"), allowing mounting on a wide variety of different basses.
- Included with the GK-3B are special holders, spacers, and other accessories, which allow you to easily attach the unit to any of a wide variety of bass models.
- You can use the controller switches to control the various functions of connected GK devices.

## About the GK-3B Warranty

---

Roland guarantees the GK-3B (and all included parts) to be free of defects in materials and workmanship. Contact your retailer or nearest Roland Service Center if repairs become necessary.

Roland cannot be responsible for any damage caused to your bass or the GK-3B as a result of your attempt to install or remove the GK-3B. If you are not confident with your ability to properly install the Pickup or Controller unit (especially where drilling is involved), please contact your Roland retailer or nearest Roland Service Center.

# Panel Descriptions

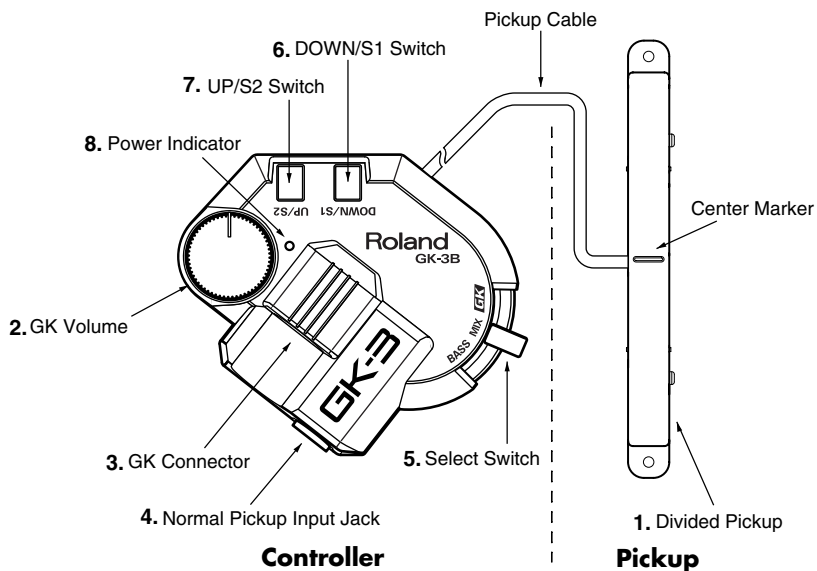

## 1. Divided Pickup

This is a pickup that senses the vibration of the bass strings. Attach it by the bridge of your bass.

## 2. GK Volume

This controls the volume of the connected GK device.

\* Certain GK-compatible devices also permit the GK Volume function to be changed. For more detailed information, refer to the Owner's Manual for the GK device being connected.

## 3. GK Connector

Connect the GK device to this connector.

## 4. Normal Pickup Input Jack

This jack is for inputting the bass's normal pickup signals to the GK-3B. Connect using the normal guitar cable included with the GK-3B.

## 5. Select Switch

This switches between the output from the connected GK device and the normal bass output.

\* Changing the GK Volume function also changes the function of this switch. For more detailed information, refer to the Owner's Manual for the GK device being connected.

## 6. DOWN/S1 Switch

## 7. UP/S2 Switch

The function of the S1 and S2 switches varies according to the connected GK device. For more detailed information, refer to the Owner's Manual for the GK device being connected.

## 8. Power Indicator

This indicates that power is being supplied to the GK-3B. Power to the GK-3B is supplied by the connected GK device via the GK cable. No battery or other power source is required.

# Attaching the GK-3B to the Bass

The GK-3B can be attached to and used with conventional electric basses. Please read the following precautions before installing the GK-3B.

## Precautions Before Installing

---

- Do not use the GK-3B on basses with doubled strings or other highly customized basses, piccolo basses and other basses with unusual tunings, or basses with other non-metallic core strings. The pickup may not function properly in such cases.
- Make any adjustments to the bass neck, string height, and other such modifications before installing the GK-3B.
- Try placing the divided pickup and the controller unit on the bass before actually attaching them to confirm that there will be no problem with the installation.
- When using the screw to attach the controller, we recommend that you first attach the GK-3B temporarily using the special holder, then after confirming that there are no problems when actually performing with the unit, secure it with the screw.
- If only the double-sided tape is used to attach the controller, shocks from rough handling during performances and from extended use will cause the tape to deteriorate, with the controller shifting out of position as a result. Also, if the finish on your bass is less than perfect, you may discover that the finish is also removed when you later remove the tape. The supplied tape is intended to be used only very temporarily, to help you determine the optimum position for the controller.
- With certain basses, the space between the pickup at the bridge position and the bridge itself is too narrow to allow installation of the divided pickup. In such instances, it may be possible to attach the pickup by modifying the bass (for example, by moving the bridge pickup more towards the neck to make room for the divided pickup); consult your bass dealer.
- When attaching the GK-3B to the bass, you should try to orient the unit so no buttons or controls get damaged, and handle with care to avoid dropping it, or allowing it to fall or tip over.

Confirm that the package contains all of the following parts for installing the GK-3B.

**Flat-head Screw 3x16 mm**

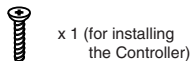

**Wood Screw 3x20 mm**

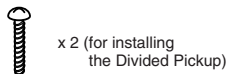

**Spring**

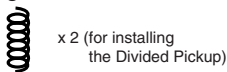

**Double-sided tape A**

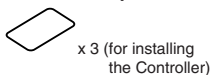

**Double-sided tape B**

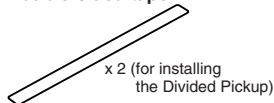

**Controller Cushion**

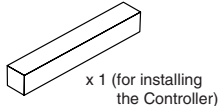

**Holder A**

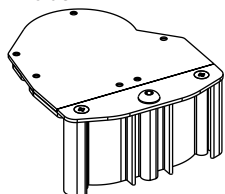

**Normal Guitar Cable**



**Pickup Cushion**

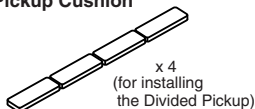

**Pickup Spacer A**

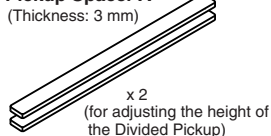

**Pickup Spacer B**

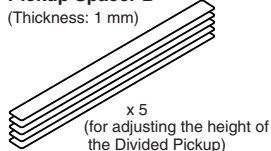

**Pickup Spacer C**

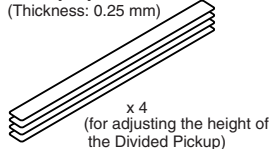

**Holder B**

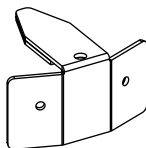

**Hexagon Socket Screw Key**



**Screw 5 x 20 mm**

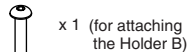

**Screw 5 x 8 mm**

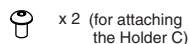

**Spring Washer**

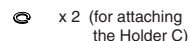

**Flat Washer**

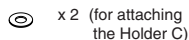

**Clearance Gauge**



**Cord Hook**



**Holder C**

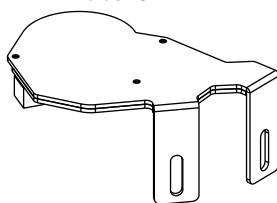

**Screwdriver**



## Adjusting the Divided Pickup

As string spacings vary with the model of the bass, the spacing between each of the coils in the pickup must be adjusted to match the particular bass. Unless this adjustment is made accurately, the GK-compatible device will not function at its full potential, or may not operate correctly. Please make this adjustment with care.

### 1. Measure the distance between strings on your bass.

To determine the distance between each string, you can measure the distance between string 1 and string 4 (or depending on the number of strings, 5 or 6) at the location in which to install the pickup (p. 9–p. 12), and divide by one less than the number of strings (i.e., in the case of a four-string bass, divide by three).

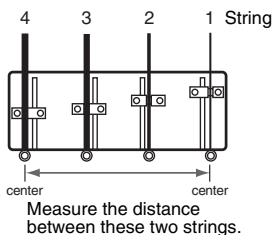

Example: a distance of 57 mm  
57 divided by (4-1) = 19 mm

### HINT

A gauge with pitches of 16, 17, 18, and 19 mm is printed on the GK-3B package, and you can also determine the spacing by placing this gauge against your bass.

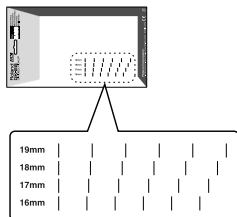

### 2. Use the included screwdriver to loosen the screws, move the markers to the position of the appropriate distance between each string, and tighten the screws.

\* Be careful not to tighten the screws excessively.

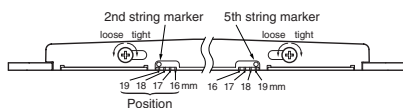

\* This adjustment made so that both markers are at the same position.

\* Be careful when moving the markers; do not use excessive force.  
Be especially careful with those at both sides of the markers.

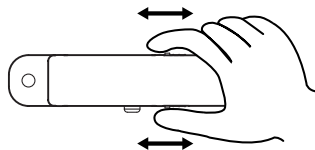

# Attaching the Divided Pickup

There are two ways to attach the divided pickup.

## ● Attaching the Pickup with Double-Sided Tape (p. 9)

This provides the simplest way to attach the pickup to flat-top basses.

- \* Do not place any unnecessary strain on the cable connecting the pickup and the controller. This may result in breaking.
- \* Do not bend or twist the pickup. Use particular care when removing the pickup.

## ■ Attaching the Pickup with Double-Sided Tape

### 1. You decide on the location in which to install the pickup.

#### For a 4-string bass:

Attach the divided pickup so that the center marker is between strings 2 (D) and 3 (A), the 2nd string marker is directly below string 1 (G), and the 5th string marker is directly below string 4 (E).

(Viewed from above)

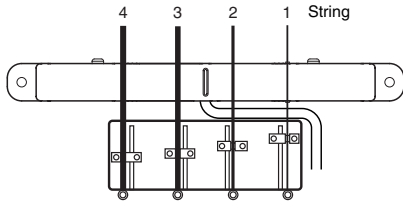

(Viewed from the neck)

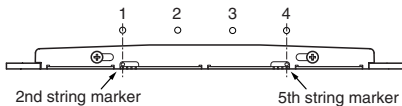

- \* Depending on the GK-compatible device, it is possible to install the pickup so that the center marker is between strings 1 and 2, or between strings 3 and 4. Refer to the manual for your GK-compatible device.

## ● Attaching the Pickup with Screws (p. 12)

This method features the benefit of allowing the pickups to be finely adjusted later on, but it is somewhat difficult to carry out.

#### For a 5-string bass:

Attach the divided pickup so that the center marker is between strings 2 (D) and 3 (A), the 2nd string marker is directly below string 1 (G), and the 5th string marker is directly below string 4 (E).

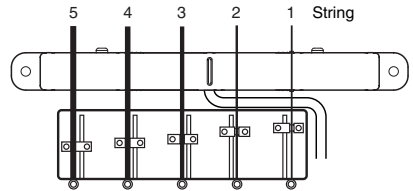

- \* Depending on the GK-compatible device, it is possible to install the pickup so that the center marker is between strings 3 and 4. Refer to the manual for your GK-compatible device.

#### For a 6-string bass:

Attach the divided pickup so that the center marker is between strings 3 (D) and 4 (A), the 2nd string marker is directly below string 2 (G), and the 5th string marker is directly below string 5 (E).

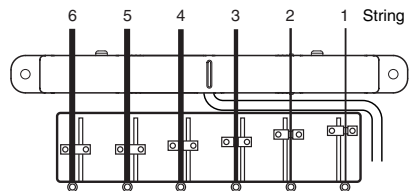

## Attaching the GK-3B to the Bass

- \* The divided pickup must be installed in the correct orientation. Make sure that the cable from the divided pickup is extending from the bridge side.
- \* When mounting the pickup on a left-handed bass, orient the pickup with the cable extending towards the neck.

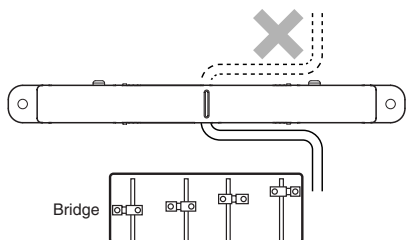

- \* Install the divided pickup close to the bridge. In any case, do not install the pickup more than 50 mm away from the bridge.

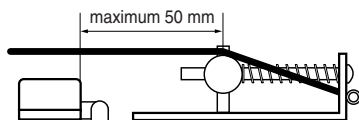

When you have decided on the location in which to install the pickup, use pencil or tape to mark that location.

### 2. Tune each string to its normal tuning, and then be sure the neck curvature and string height are set properly.

Any adjustments to the neck bow or string height should be done at this point.

- \* Changes in the string height following installation of the divided pickup may cause the clearance between the strings and the pickup to change, which can result in poorer sensitivity.

### 3. Adjust the height of the pickup.

Insert the supplied spacers under the pickup until it is at the required height (do not remove the backing from the tape yet).

There are three types of pickup spacers, "A" (3 mm), "B" (1 mm) and "C" (0.25 mm); combine these as necessary to achieve the proper pickup height.

- \* The pickup height should be set so that the clearance between the strings and the pickup is approximately 1.5 mm (0.6") when the top and bottom strings are pressed at the highest fret. Adjust the number of spacers while confirming the clearance with the included (1.5 mm thickness) clearance gauge (p. 12).
- \* If the top and bottom string heights differ greatly when the highest fret is fingered, compensate by adding the appropriate half-length or one-third length spacers until the clearance for both strings is the same.
- \* When using an arch-top bass, put the pickup cushions under the pickup spacers.

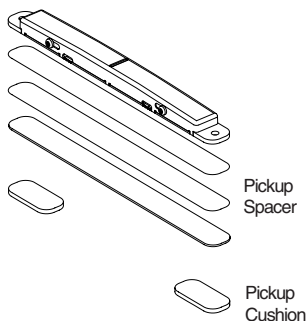

- \* Adjust the pickup cushion thickness as required, for example by using two pickup cushions.
- \* The pickup spacers and the pickup cushions are attached to the bass with double-sided tape. When affixing the tape, however, the tape's thickness is reduced by 0.1 mm (0.004") when the backing of the tape is removed. Therefore, when using several pickup spacers, take this fact into account and set the height slightly higher to compensate.

### 4. Remove the strings from the bass.

## 5. Remove the backing from the tapes for the pickup cushion, the pickup spacers, and the pickup, and carefully attach the pickup to the bass.

- \* After affixing these items, press them so that the items adhere firmly.
- \* Wipe off any dust that may be on the location to which you're affixing the double-sided tape. If the location is dusty or dirty, the double-sided tape may not adhere sufficiently.

## 6. Restring and tune the bass, then carefully check the height of the divided pickup once more.

Measure with the clearance gauge to confirm that the clearances between the pickup and the strings are approximately 1.5 mm (0.06") when you press the top and bottom strings at the highest fret, then finish up by making sure that the strings do not touch the pickup when you play the bass.

Then attach the cord hook near the bridge, and fasten the pickup cable in the hook so that it does not lift up or touch the strings.

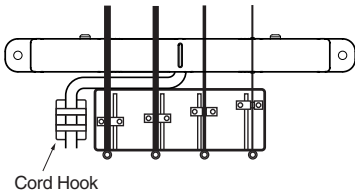

## 7. Take the steps below if the height of the divided pickup is not right.

- 1) Carefully examine the pickup in its current state, and add a suitable number of spacers if the pickup is too low, or remove one or more spacers if the pickup is too high.
- 2) Remove the strings from the bass.
- 3) Remove the divided pickup from the bass.

- \* Use care in handling the divided pickup; bending or twisting it may cause breaking in the coil elements. Carefully insert something thin and flat (like a table knife) under the Pickup from the bottom string side, then gently pry the pickup upwards.

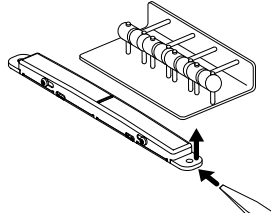

- 4) After removing the pickup, carefully remove the double-sided tape from the bottom of the pickup.
- 5) Adjust the height of the Pickup. If you wish to add a spacer, first completely remove the used double-sided tape from the top surface of the existing spacers, then add the new spacer. If you need to remove any spacers, remove the necessary number of spacers and completely remove the remaining double-sided tape from the top surface.
- 6) Attach a piece of the new double-sided tape to the bottom of the pickup.

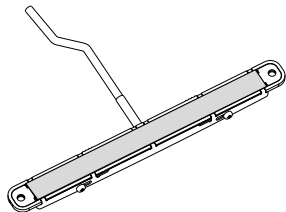

- 7) Attach the pickup to the top of the spacer that is applied to the bass side.
- 8) Restring and tune the bass, then check the height of the Divided Pickup again.

- \* Afterwards, you will need to adjust the pickup sensitivity when connecting to GK devices. However, you may find that the sensitivity level on the GK device is too high. In such instances, you may be able to correct the problem by widening the clearance between the strings and the pickup. Carry out Steps 1 through 8 again to lower the Pickup height slightly.

### How to Use the Clearance Gauge

The divided pickup height must be adjusted so that the clearance between each string and the divided pickup is 1.5 mm (0.06") when the highest fret is fingered.

The clearance gauge supplied with the GK-3B is 1.5 mm thick; place the gauge between the strings and the divided pickup as shown in the figure below, then check and adjust the height.

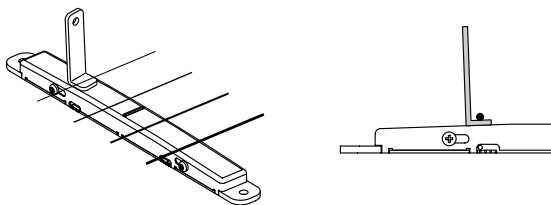

### ■ Attaching the Pickup with Screws

The steps for determining the position for attaching the pickup and for checking the height are exactly the same as when using the double-sided tape. Refer to "Attaching the Pickup with Double-Sided Tape" (p. 9).

- \* If mounting the GK-3B with screws, ensure a minimum string clearance of 15.5 mm (0.6") from the body at the position where the pickup is positioned.

**1. Determine the position for attaching the pickup.** When you have determined the positioning, mark the position of the holes at each end of the pickup on the bass's body.

**2. Remove the strings from the bass.**

**3. Using a drill or similar means, open pilot holes where the attachment screws are to go in.**

- \* If the pilot holes are not made in the correct positions, then the pickup will not be attached in the correct position either. Use extra care when drilling the pilot holes.

- \* Make the pilot holes approximately 2 mm (0.08") in diameter.
- \* Drill pilot holes slightly more than 2 mm in diameter if the bass body is made of a particularly hard material.

**4. Place the springs between the pilot holes and the pickup as shown in the figure below, then secure the pickup with the screws.**

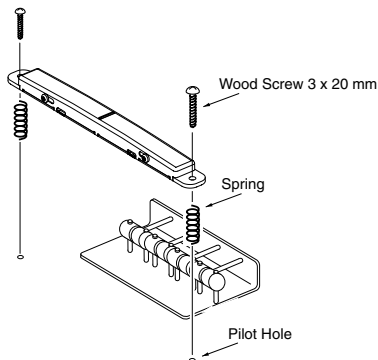

**5. Restring and tune the bass.****6. Adjust the height of the pickup.**

\* Adjust the mounting screws, loosening or tightening them as required so that the clearance between the strings and the pickup is approximately 1.5 mm (0.06") when the top and bottom strings are pressed at the highest fret. Check the height using the supplied clearance gauge (1.5 mm thickness).

- \* Afterwards, when connecting to GK devices, you will need to adjust the pickup sensitivity again. However, you may find that the sensitivity level on the GK device is too high. In such instances, you may be able to correct the problem by widening the clearance between the strings and the pickup, so try lowering the Pickup height slightly to see if this approach is effective.
- \* If the springs are too long, use a pair of wire clippers to cut them to the correct size.

## Attaching the Controller

There are two ways to attach the controller.

**● Attaching the Controller Unit with Holder (p. 14)**

This allows the controller to be mounted easily, with no modification of the body required.

**● Attaching the Controller Unit with Double-Sided Tape and Screws (p. 18)**

This allows the controller to be mounted at any desired position on the bass, and without the use of the holder, makes for a thinner controller following installation. However, it is somewhat difficult to carry out.

### ■ Adjusting the Length of the Pickup Cable

Place the controller where it is actually to be attached to the bass to check the pickup cable length. If the cable is too long, wind it up in the space behind the controller.

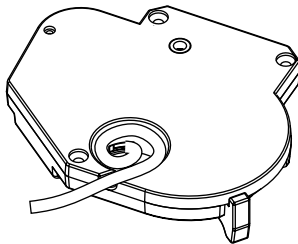

## ■ Attaching the Controller with the Holder

Refer to the following figures showing examples of ways to mount the controller, then select the most suitable method for the bass at hand.

### Installation Examples

#### Example 1) Mounting on the Front of the Bass

This method is recommended for basses with sufficient space on the bass's top to mount the controller (p. 15).

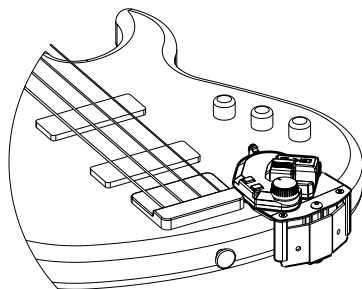

#### Example 3) Mounting on the Back of the Bass

If there is insufficient space to install the controller on the bass top, you can use this method to mount the controller to the back of the bass (p. 17).

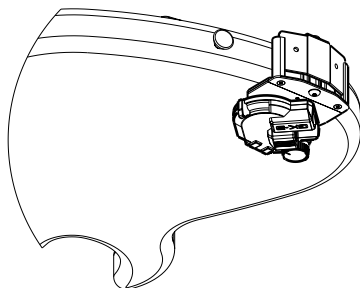

#### Example 2) Mounting Over the Bridge

If there is insufficient space to install the controller on the bass top, you can use this method to mount the controller over the bridge (p. 16).

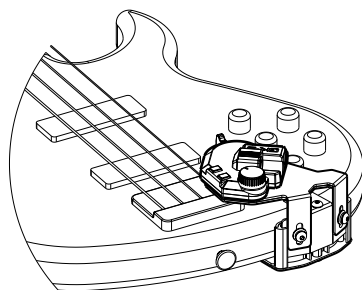

## Mounting on the Front of the Bass

1. Remove three screws from the underside of the controller, then attach the GK-3B to holder "A."

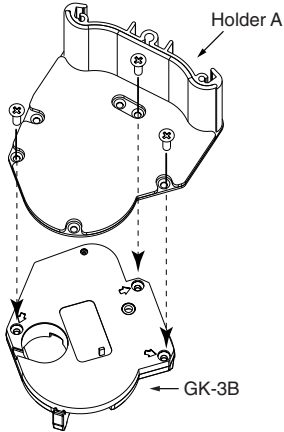

\* Holder A has six screw holes. Refer to the figure to ensure the holder is attached correctly.

2. Attach holder "B" so that the bass body is sandwiched between the two holders.

\* Make sure that Holder A is firmly pressed against the side surface of the bass body.

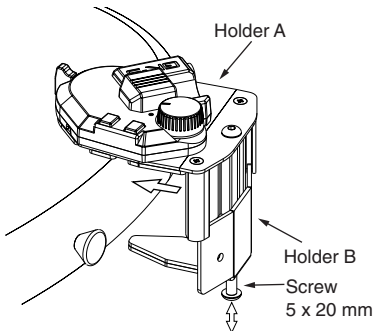

3. Tighten holders "A" and "B" using the screw (5 x 20 mm).

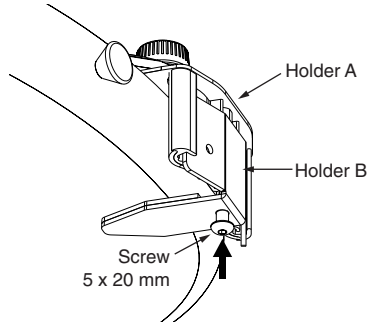

## Mounting Over the Bridge

- 1. Attach holders "A" and "B" so that the bass body is sandwiched between the two holders.**

- \* Holder A attaches to the back surface of the bass.
- \* Make sure that Holder A is firmly pressed against the side surface of the bass body.

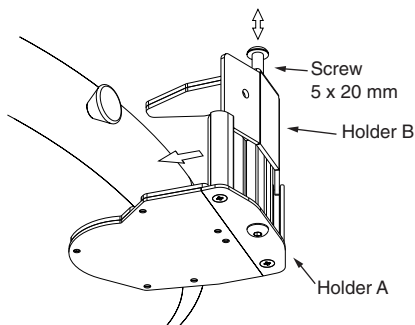

- 2. Remove three screws from the underside of the controller, then attach the GK-3B to holder "C."**

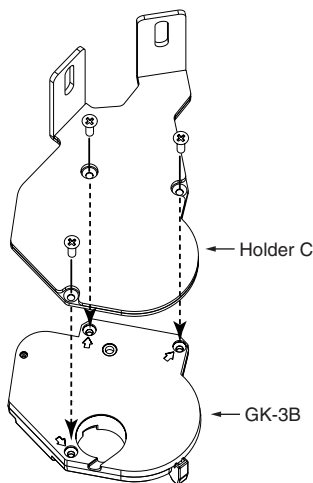

- 3. Secure Holder "C," with the controller attached to it, to Holder "B" using the flat washers, spring washers and screw (5 mm x 8 mm).**

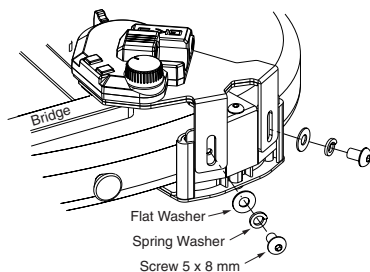

- \* If Holder "C" makes contact with the strings and interferes with performance, attach the controller cushion to Holder "C" so as to lift Holder "C" away from the instrument and prevent it from reaching the strings.
- \* First, insert the controller cushion between the bass and the holder, and determine a position that ensures that none of the string vibration will be disturbed. Then, affix the cushion.

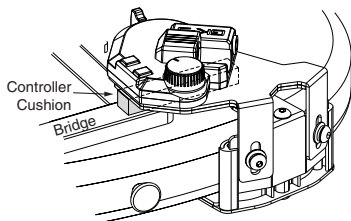
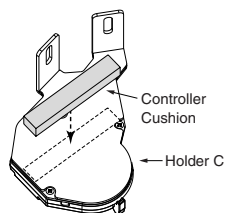

## Mounting on the Back of the Bass

1. Remove three screws from the underside of the controller, then attach the GK-3B to holder "A."

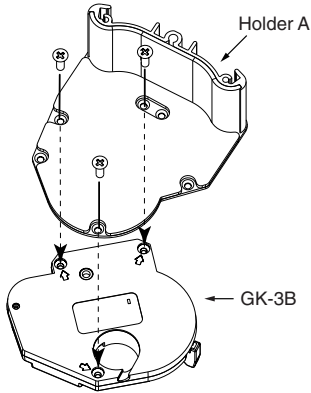

\* Holder A has six screw holes. Refer to the figure to ensure the holder is attached correctly.

2. Attach holder "B" so that the bass body is sandwiched between the two holders.

\* Make sure that Holder A is firmly pressed against the side surface of the bass body.

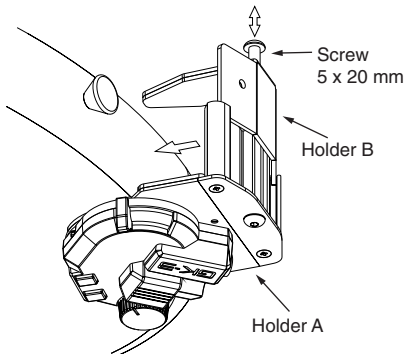

3. Tighten holders "A" and "B" using the screw (5 x 20 mm).

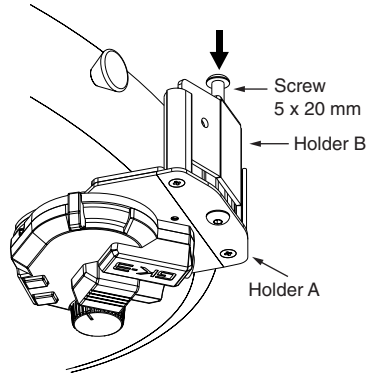

## ■ Attaching with Double-sided Tape and a Screw

**1. Place the controller in an appropriate position on the bass surface to determine where it is to be attached. Pay attention to the following points at this time.**

- Install on a level surface.
- Position the controller so it does not interfere with your playing.
- Position the controller so you can comfortably operate the select switch, the S1 and S2 switches, and other controls.

• Position the controller so that it does not place undue strain on the normal pickup input jack, divided pickup, or GK cable.

\* *Make sure that the plugs connected to the GK connector and normal pickup input jack do not stick out, as this may result in damage should undue strain be placed on the GK connector or normal pickup input jack.*

**2. Once the controller position has been determined, place the controller in position and carefully drill a pilot hole in the bass body where the controller's attachment hole is located.**

\* *The diameter of the hole should be about 2 mm (0.08").*

\* *Confirm that there are no other problems in attaching the controller before drilling the pilot hole.*

**3. After attaching the double-sided tape "A" to the underside of the Controller, attach the controller to the bass.**

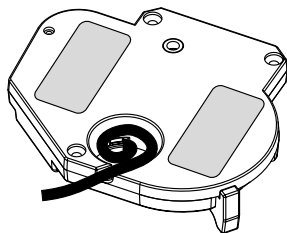

**4. Secure the controller with the supplied flat-head screw (3 x 16 mm).**

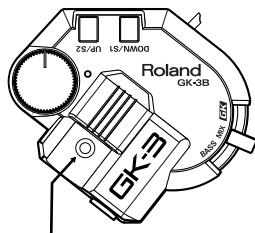

Put the flat-head screw (3x16 mm) through this hole.

\* *If you'd rather not drill a hole in your bass, you can secure the Controller using only the double-sided tape or the holders. However, if only the double-sided tape is used to secure the unit, shocks from rough handling during performances and from use over an extended period will cause the tape to deteriorate, with the GK-3B shifting out of position as a result. Furthermore, if the finish on your bass is less than perfect, you may discover that the finish is also removed when you later remove the tape.*

# How to Connect the GK-3B

- \* To prevent malfunction and/or damage to speakers or other devices, always turn down the volume, and turn off the power on all devices before making any connections.
- \* When all devices are properly connected, turn on the power to the various devices in the order specified below. Turning on devices in the wrong order may result in malfunction and/or damage to speakers and other devices.

## 1. Make sure that the power to the device being connected is turned off, then connect the device to the GK-3B's GK connector using the GK cable.

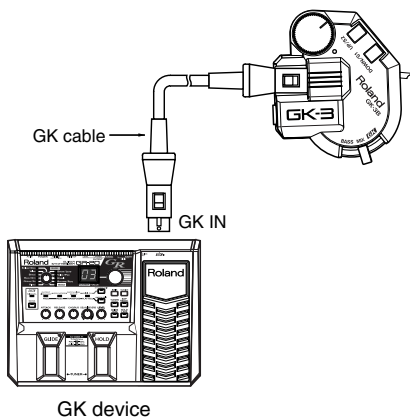

### NOTE

Connect the GK-3B only with dedicated GK cable (supplied with Roland GK-compatible devices and optional GK cables sold by Roland). Use of any other cable may result in damage or malfunction.

- \* The GK cable is a locking cable. When disconnecting the cable, do not pull on it with undue force, but instead release the lock and gently disconnect the cable. You can disconnect the cable simply and easily by holding down the locking portion with your thumb and gently pulling on the plug.

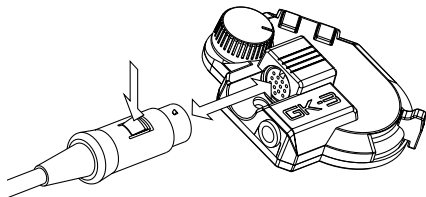

- \* Before playing, be sure to wrap the cable around the guitar strap near the end pin. This will prevent the excess strain on the cable that can end up damaging the bass or the GK-3B.

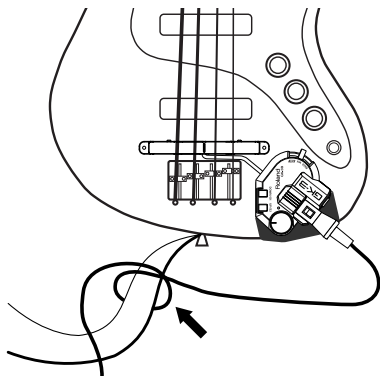

- 2. Use the included normal guitar cable to connect the output jack on the bass to the GK-3B's normal pickup input jack.**

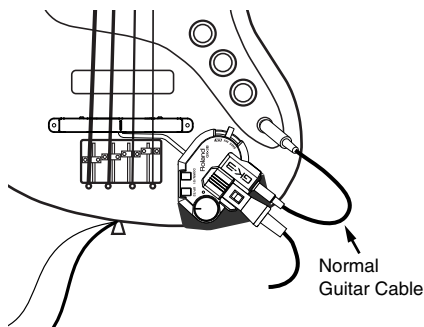

- \* Connect using the included normal guitar cable or a commercially available guitar cable. Note that the use of connection cables that introduce additional resistance may result in lower normal bass volume.
- \* This connection is necessary not only for playing the bass's normal (straight) sound as well as the bass's straight sound mixed with the sound from the connected GK device, but also for connecting the bass's ground and the GK-3B's ground. Even if you are not going to use the bass's straight sound at all, always make this connection because of the noise reduction benefits it provides.

- 3. Turn on the power to the connected GK device.**

The Power indicator on the controller lights up. Now, when you play your bass you'll hear the sound of the connected GK device.

- \* The power indicator lights up when the GK-3B and the GK device are properly connected with a GK cable and the power to the GK device is turned on.
- \* Always make sure to have the volume level turned down before switching on power. Even with the volume all the way down, you may still hear some sound when the power is switched on, but this is normal, and does not indicate a malfunction.

# Specifications

## GK-3B: Divided Pickup

### ● Controls

GK Volume  
DOWN/S1 Switch  
UP/S2 Switch  
Select Switch

### ● Indicator

Power Indicator

### ● Connectors

GK Connector  
Normal Pickup Input Jack

### ● Weight

70 g / 3 oz

### ● Accessories

Normal Guitar Cable  
Parts for installation  
Owner's Manual

### ● Options

GK Cables: GKC-3, GKC-5, GKC-10  
GK Parallel Box: GKP-4  
Unit Selector: US-20

### ● Dimensions

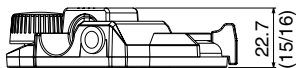
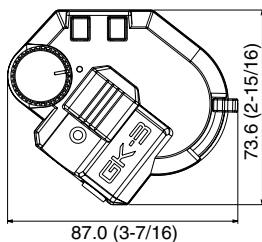

Unit : mm (inch)

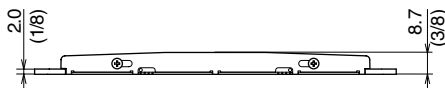
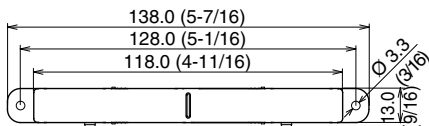

Unit : mm (inch)

\* In the interest of product development, the specifications and/or appearance of this unit are subject to change without prior notice.



Manufacturer: Roland Corporation  
2036-1 Nakagawa, Hosoe-cho, Kita-ku, Hamamatsu, Shizuoka 431-1304, JAPAN

Importer: Roland Corporation  
ENA 23 Zone 1 nr. 1620 Klaus-Michael Kuehnelaan 13, 2440 Geel, BELGIUM

For EU Countries



Manufacturer: Roland Corporation  
2036-1 Nakagawa, Hosoe-cho, Kita-ku, Hamamatsu, Shizuoka 431-1304, JAPAN

Importer: Roland Europe Group Limited  
Hive 2, 1530 Arlington Business Park, Theale, Reading, Berkshire. RG7 4SA United Kingdom

For the U.K.





## Roland Service Centers and Distributors

When you need repair service, access this URL and find your nearest Roland Service Center or authorized Roland distributor in your country.

<https://roland.cm/service>



Roland Corporation